



24





## INTRODUCTION

# Integrated Freedom.

„Grip in integration“ is our slogan for our G-Link system, which we released last year. Since then, everything at CONTEC has revolved around integration. And you will notice this in our new range of bike parts. We are particularly proud of our AirTag bracket series Clue, which can be mounted hidden on your bike. Or of our new Treasure minitools, which can be integrated into the steering shaft and the end of the handlebars of your bike.

Our new wheels also follow the theme of „integration is everything“. With a combination of existing and new product groups, such as the new rims and hubs, we have finally made it possible to equip complete wheel sets with CONTEC parts.

Our goal is to enable every cyclist to individualise and improve their bike with clever tools and high-quality bike parts. After all, why shouldn't we simply optimise and repair our bike instead of buying a new one? It's time to rethink! For you as well as for the environment. Speaking of the environment: did you know that we have been eliminating plastic from our packaging as much as possible since 2021? We don't just do this for our new parts, we are also working on making our existing product packaging plastic-free.

We are now pleased to present our range of new bicycle parts for the year 2024.

Have fun with it!





# Our three segments

**Make your bike better.** With our components you have it in your hands. Because you will find in our extensive workshop and spare parts range everything that your screwdriver heart desires to bring your bike in shape. Whether our Rock Steady assembly stand or the bottom bracket wrench from our series Tools for Professionals - with our tools and parts you can do the most important maintenance work yourself.

**Your bike, your adventure.** With our parts you are perfectly equipped to reach your goal. Wherever you are, whether on the road, in the mountains or on trekking bike tour - the components and accessories from our range give you the upgrade in performance and comfort that you need. Perfectly equipped for your next overnigher you are with our Mile Grinder Bike Packing bags. Ride your e-bike more comfortably with our Nara Drop Air DLX dropper seatpost. Get even

more stability and a stiffer cockpit on your E-MTB with our 35mm handlebar-stem combinations - so you can face the next downhill passage relaxed.

**Ride your style.** Discover individual accessories for your look. In our parts and accessories range, you'll find everything you need to customize your bike to your own personal style. We provide you with the parts to make your bike unmistakably yours. Either with coordinated component colors from our Brut Select range, the brown leather components from the Classic collection or, for example, the stylish and practical bag VIA series.

## CONTENT

### What's to discover

Topic	Page	Topic	Page
Bells	124-133	Locks	298-311
Bottom brackets	204-209	Merchandise	398-405
Brakes	50-83	Mirrors	138-141
Care agents / puncture protection	328-337	Pedals	224-243
Carriers / bags	250-271	Pumps	194-203
Cassettes	244-249	Saddles	150-171
Chains	212-223	Seatposts	172-189
Chain rings	210-211	Shifting accessories	292-297
Clothing	376-397	Stands	272-283
E-bike protection	190-193	Smart accessories	134-137
Fenders	284-291	Stems / handlebars	30-49
G-Link	104-113	Tools	344-367
Grips	84-103	Tubeless	338-343
Helmets	368-375	Water bottles	114-123
Headsets	142-149	Wheels	312-327
Lights	8-29		







#### DAYLIGHT

Lighting that provides better visibility in traffic during the day; works by a sensor inside the lamp or by a separate switch.



#### STEADY

The standlight function ensures good visibility at every stop with dynamo lighting



#### LUX

It is measured at a distance of 10 meters from the light source. The higher the value, the brighter the light.



#### BATTERY LIGHT

Battery lights have their own power source in the form of replaceable batteries or permanently installed rechargeable batteries



#### SENSOR

The light-dark sensor automatically detects when light is needed and switches on and off independently.



#### ON/OFF POWER

Switch to turn your light on and off.



#### STOPTEC

A sensor registers the braking process and lets your taillight light up brightly.



#### VOLT

Only lights that are compatible with the system voltage of your e-bike, can be operated by this.



#### E-READY

Suitable for your e-bike, suitable for the current voltage.



#### HIGH BEAM

High beam for extra high safety. Can be operated by remote pushbutton



#### USB

Chargeable via USB.



#### G-LINK

Compatible with CONTEC G-Link grips. Components with this sign can be space-saving and ergonomic mounted directly on the G-Link grip. Compatible with CONTEC G-Link grips.

## LIGHTS



# Your ray of light for your bike

Riding fun all the time - our DLUX front lights illuminate your way reliably and generously, so that you do not have to miss your bike even during the dark seasons. The DLUX 120 E-XTENT is our first StVZO-compliant high beam with up to 200 LUX. The special feature of the e-bike front light is the wireless remote control for the handlebar. Those who would like it to

be even more flexible should take a look at our mobile DLUX battery lighting series: The brightest models DLUX micro power 120 and 80 have a detachable, powerful battery that can even be used as a power bank while riding. On our new YouTube channel, we present the various functions of our battery lighting in detail.



DLUX MICRO POWER 120 P.20



DLUX 120 E-XTENT P.10

# First class remote switching

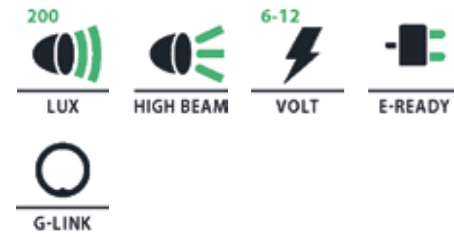

## DLUX 120 E-XTENT

- low beam 120 lux / 350 lumen
- high beam 200 lux / 1850 lumen
- OSRAM LED
- incl. high beam button with radio control
- for connection to an e-bike battery with 6-12V
- incl. plastic universal bracket
- aluminium housing
- with removable front reflector
- incl. Contec G-Link system and standard handlebar clamp

0.710.970/5 black 019995



# E-bike lights

Maximum brightness and maximum performance: In our lighting program, we offer you and your e-bike a wide range of different brightness levels and designs. We have lights available for a variety of system voltages. The DLUX 120 E-XTENT is our brightest front light

for e-bikes so far, with 200 lux and 1850 lumens. The high beam can be easily switched on and off using the included handlebar button. For a clean look on the handlebar, the wireless remote control is also equipped with the CONTEC G-Link interface.



## DLUX 120 E+

- 120 lux OSRAM LED / 262 lumen
- for connection to the E-bike battery with 6-12V
- incl. plastic universal bracket
- aluminium housing
- with removable front reflector

0.710.934/1 bulk  
0.710.935/8 self-service package

007995  
007995



## DLUX 80 E+

- 80 lux OSRAM LED / 170 lumen
- for connection to the E-bike battery with 6-12V
- incl. plastic universal bracket
- aluminium housing
- with removable front reflector

0.710.932/5 bulk  
0.710.933/3 self-service package

003995  
003995



## DLUX 50 E+

- 50 lux OSRAM LED / 112 lumen
- for connection to the E-bike battery with 6-12V
- incl. plastic universal bracket
- plastic housing
- with removable front reflector

0.710.927/5 bulk  
0.710.928/3 self-service package

002995  
002995

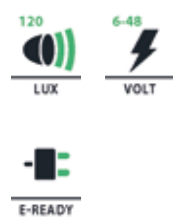

**LUNA 120 E+**

- 120 lux LED (4,5 Watt)
- for connection to E-bike battery with 6-48V
- incl. plastic bracket
- with removable front reflector
- aluminium housing
- with lighting CONTEC logo

0.710.334/4 black 005995

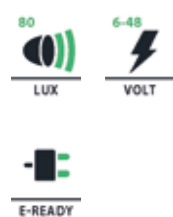

**LUNA 80 E+**

- 80 lux LED (3,0 Watt)
- for connection to E-bike battery with 6-48V
- incl. plastic bracket
- with removable front reflector
- plastic housing
- with lighting CONTEC logo

0.710.317/9 black 003995

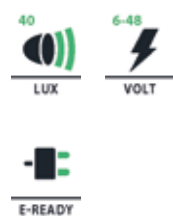

**LUNA 40 E+**

- 40 lux LED (1,8 Watt)
- for connection to E-bike battery with 6-48V
- incl. plastic bracket
- with removable front reflector
- plastic housing
- with lighting CONTEC logo

0.710.313/8 black 002995

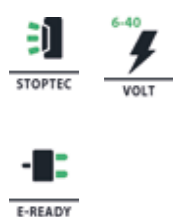

**TL-348 E-STOP**

- incl. COB-LED technology
- with stoplight function
- for connection to the E-bike battery with 6-40V
- plastic housing
- with integrated large-surface reflector

0.711.812/8 carrier attachment 50mm 003995

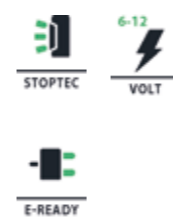

**TL-335 E-STOP**

- LED rear light with 2 red OSRAM LEDs
- with stop light function
- for connection to the E-bike battery with 6-12V
- plastic housing
- with integrated large surface reflector

0.711.930/8 carrier attachment 80mm, bulk 002495

0.711.931/6 carrier attachment 80mm, self-service package 002495

0.711.928/2 carrier attachment 50mm, bulk 002495

0.711.929/0 carrier attachment 50mm, self-service package 002495



**TL-335 E**

- LED rear light with 2 red OSRAM LEDs
- for connection to the E-bike battery with 6-12V
- plastic housing
- with integrated large surface reflector

0.711.926/6 carrier attachment 80mm, bulk 001195

0.711.927/4 carrier attachment 80mm, self-service package 001195

0.711.924/1 carrier attachment 50mm, bulk 001195

0.711.925/8 carrier attachment 50mm, self-service package 001195



**TL-328 E+**

- LED rear light with 2 red LEDs
- for connection to E-bike battery with 6-48V
- high quality plastic housing with integrated large surface reflector

0.711.808/6 carrier attachment 50 / 80mm 001395

**BOSCH:**  
6 V and 12 V switchable  
12 V  
Generation 2 ab MY2014 / Active Line till MY2017 incl. / Performance Line/CX bis incl. MY2018  
Generation 3, Generation 4 from MY2018/19

**SHIMANO:**  
6 V  
12 V  
DU-E8000  
DU-E5000, E6100, E7000

**TRANZX :**  
6 V  
all systems

**PANASONIC :**  
6 V  
all systems

**YAMAHA :**  
6 V  
from MY2017







**DLUX 80 N++**

- 80 lux OSRAM LED / 170 lumen
- for hub dynamo
- with standlight
- with automatic switch on via bright-dark-sensor
- aluminium housing
- with removable front reflector

0.710.930/9 bulk	003995
0.710.931/7 self-service package	003995



**DLUX 50 N++**

- 50 lux OSRAM LED / 112 lumen
- for hub dynamo
- with standlight
- with automatic switch on via bright-dark-sensor
- plastic housing
- with removable front reflector

0.710.925/9 bulk	002995
0.710.926/7 self-service package	002995

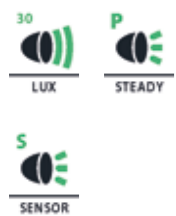

**DLUX 30 N++**

- 30 lux OSRAM LED / 75 lumen
- for hub dynamo
- with standlight
- with automatic switch on via bright-dark-sensor
- plastic housing
- with removable front reflector

0.710.920/0 bulk	001595
0.710.921/8 self-service package	001595



**LUNA 80**

- 80 lux LED
- for hub dynamo
- with removable front reflector
- incl. plastic bracket
- plastic housing
- with lighting CONTEC logo
- black

0.710.315/3 Luna N+, with switch for hub dynamo, with standlight	004495
0.710.316/1 Luna N++, with switch for hub dynamo, with standlight, with automatic switch on via bright-dark sensor	004995



**LUNA 40**

- 40 lux LED
- for hub dynamo
- with removable front reflector
- incl. plastic bracket
- plastic housing
- with lighting CONTEC logo
- black

0.710.311/2 Luna N+, with switch for hub dynamo, with standlight	002595
0.710.312/0 Luna N++, with switch for hub dynamo, with standlight, with automatic switch on via bright-dark sensor	002995



**HL-2000 B**

- 40 lux and 15 lux LED
- integrated lithium-ion battery
- toolfree assembly and charging via USB
- incl. stainless steel bracket and USB charging cable
- with integrated front light

0.710.814/5 black	004495
-------------------	--------



**RETRO CLASSIC**

- 20 lux LED
- incl. stainless steel bracket and cable
- with integrated front reflector
- silver

0.710.820/2 Retro Classic N, with switch for hub dynamo	002495
0.710.821/0 Retro Classic N+, with switch for hub dynamo, with standlight	002595



**TL-135**

- LED rear light with 2 red OSRAM LEDs
- dynamo powered
- with standlight
- with integrated large surface reflector

0.711.922/5 carrier attachment 80mm, bulk	001095
0.711.923/3 carrier attachment 80mm, self-service package	001095
0.711.920/9 carrier attachment 50mm, bulk	001095
0.711.921/7 carrier attachment 50mm, self-service package	001095



**TL-128**

- LED rear light with two bright LEDs
- dynamo powered
- with standlight function
- with integrated large surface reflector

0.711.804/5 carrier attachment 50 / 80mm	001395
--	--------



**TL-116**

- LED rear light with 1 red LED
- dynamo powered
- fender attachment
- with integrated rear reflector

0.711.800/3 with standlight	001095
-----------------------------	--------



**TL-117**

- LED rear light with 1 red LED
- dynamo powered
- fender attachment
- with integrated reflector

0.711.801/1 with standlight	001095
-----------------------------	--------

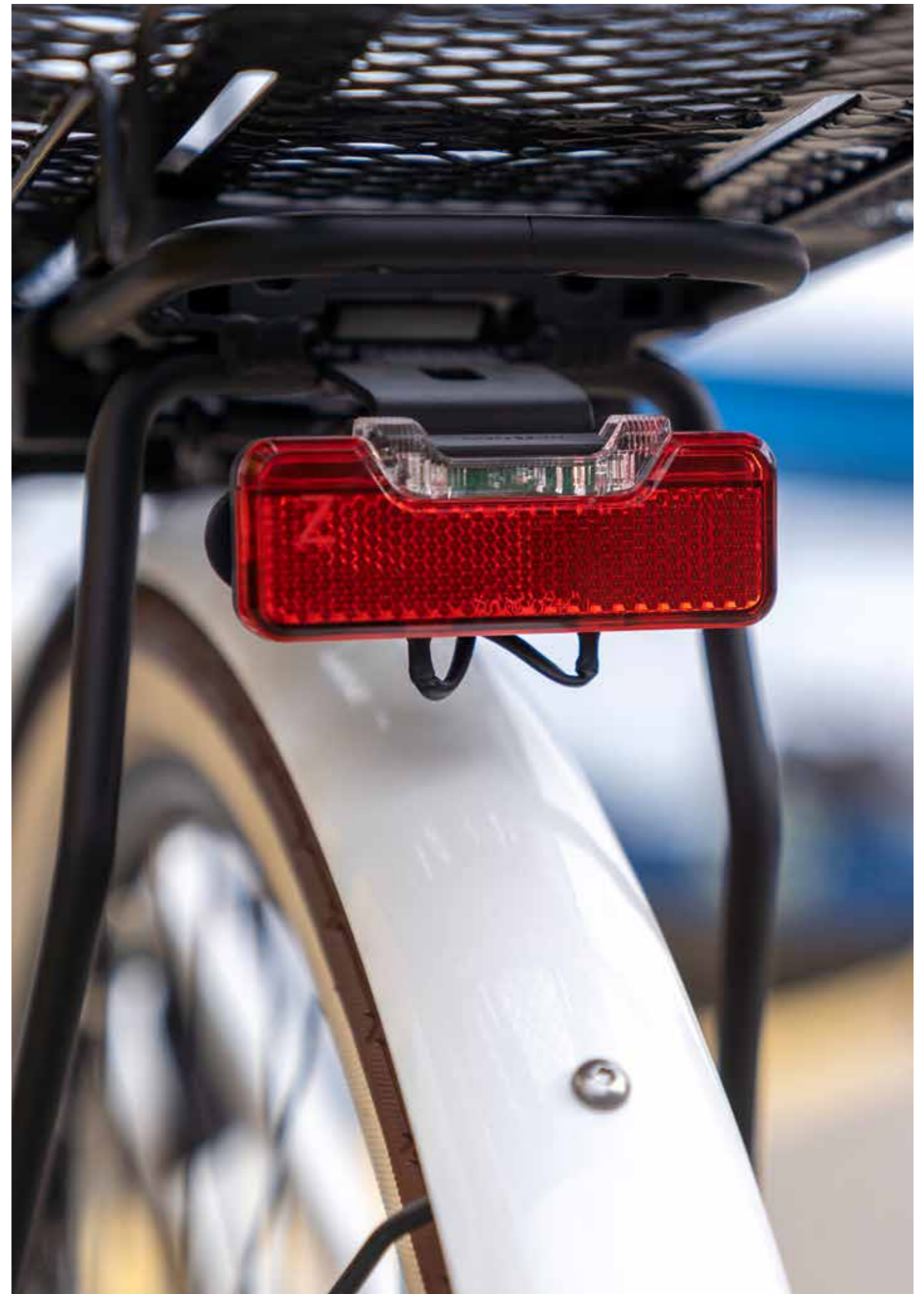



# Multitasking master



## DLUX MICRO POWER 120

- LED front light with 120 lux / 290 lumen and 4 brightness levels
- LED rear light with 8 lumen and stoplight function
- front light using time up to 30 hrs.
- rear light using time up to 10 hrs.
- with removable 5000 mAh lithium-ion battery
- incl. powerbank function of the battery
- rechargeable via USB port

0.710.525/7 matt black 012995



## DLUX MICRO POWER 80

- LED front light with 80 lux / 200 lumen and 4 brightness levels
- LED rear light with 8 lumen and stop light function
- front light using time up to 20 hrs.
- rear light using time up to 10 hrs.
- with removable 3500 mAh lithium-ion battery
- incl. PowerBank function of the battery
- charging via USB

0.710.524/0 matt black 008995



## DLUX MICRO 40

- LED front light with 40 lux / 120 lumen and 2 brightness levels
- LED rear light with 8 lumen
- front light using time up to 12 hrs.
- rear light using time up to 10 hrs.
- with integrated 2000 mAh lithium-ion battery
- charging via USB

0.710.523/2 matt black 004995



## 24SEVENSTOP

- LED front light with 1 white LED (70 lux) and sensor
- LED rear light with 1 red LED and stop light function
- with integrated Lithium-Ion batteries
- rechargeable via USB

0.710.376/5 black / grey 005995



## LS-247 SLIM

- LED front light with 1 white LED (30 lux)
- LED rear light with 1 red LED
- incl. 5 AAA batteries

0.710.335/1 black 002495





**DLUX MICRO POWER 120**

- LED front light with 120 lux / 290 lumen and 4 brightness levels
- using time up to 30 hrs.
- with removable 5000 mAh lithium-ion battery
- incl. Powerbank function of the battery
- charging via USB

0.710.522/4 matt black 009995



**DLUX MICRO POWER 80**

- LED front light with 80 lux / 200 lumen and 4 brightness levels
- using time up to 20 hrs.
- with removable 3500 mAh lithium-ion battery
- incl. Powerbank function of the battery
- charging via USB

0.710.521/6 matt black 006995



**DLUX MICRO 40**

- LED front light with 40 lux / 120 lumen and 4 brightness levels
- using time up to 12 hrs.
- with integrated 2000 mAh lithium-ion battery
- charging via USB

0.710.520/8 matt black 003995



**HL-247 SLIM**

- LED front light with 1 white LED (30 Lux)
- incl. 3x AAA micro batteries

0.710.336/9 black 001495



**DLUX MICRO XS STOP**

- LED rear light with 8 lumen
- with stop light function
- integrated lithium-ion battery
- using time up to 10 hrs.
- charging via USB
- incl. bracket and charging cable

0.711.007/5 matt black 003495



**DLUX MICRO XS**

- LED rear light with 8 lumen
- integrated lithium-ion battery
- using time up to 10 hrs.
- charging via USB
- incl. bracket and charging cable

0.711.006/7 matt black 002495





**TL-104**

- LED rear light with 3 red SMD LEDs
- Lithium battery - using time up to 3,5 hours
- rechargeable via USB, incl. cable
- mounting material for toolless assembly (e.g. seat post/helmet mounting)
- weight: 16,2g

0.311.990/6 black 002595



**TL-247 SLIM**

- LED rear light
- plastic housing
- incl. 2x AAA micro batteries

0.311.393/3 black 000995



**TL-128 USB**

- LED rear light with 2 bright LEDs
- integrated lithium-ion battery (using time: 6 hrs.)
- with integrated large surface reflector

0.711.805/2 carrier attachment 50 / 80mm 002595



**TL-128 B**

- LED rear light with 2 bright LEDs
- toolfree conversion to 50mm carrier attachment
- incl. 2x AAA micro batteries and low battery indicator

0.711.811/0 carrier attachment 50 / 80mm 001195



**DLUX MICRO POWER**

- spare battery for DLUX micro front light
- incl. PowerBank function
- rechargeable via USB connection
- incl. bracket for handlebar attachment

0.710.526/5 3500 mAh 005995  
0.710.527/3 5000 mAh 006995



**DLUX MICRO POWER**

- LED front light
- compatible with "DLUX MICRO power" batteries
- matt black

0.710.528/1 80 lux / 200 lumen 002495  
0.710.529/9 120 lux / 290 lumen 003495



**DLUX MICRO**

- Cap for front Light
- compatible with "DLUX MICRO power" 3500 mAh and 5000 mAh batteries
- to protect the contacts when using the powerbank function or using a second batterie during the transport

0.710.532/3 matt black 000395



**BETTER.EE AA**

- up to 500 times rechargeable
- current charging: 5V / 110 mA
- nominal voltage: 1,2V
- charging time approx. 8,5 hrs.
- incl. charging cable
- set with 2 pieces

0.315.037/2 AA, 1000 mAh 001095



**BETTER.EE AAA**

- up to 500 times rechargeable
- current voltage: 5V / 80 mA
- nominal voltage: 1,2V
- charging time approx. 5,5 hrs.
- incl. charging cable
- set with 2 pieces

0.315.038/0 AAA, 450 mAh 001095



**LS-002**

- LED light set
- incl. 2x CR2032

0.710.363/3 front light in white, rear light in black 000995



**LS-003**

- LED light set
- incl. lithium-ion bateries and charger
- charging per USB

0.710.364/1 white 002595



**SPARKLER W**

- LED safety light with 1 white LED
- anodized aluminium body
- ultralight and compact design
- incl. rubber ring for toolfree attachment
- incl. 2x CR-2032

0.310.471/8 black 001595



**SPARKLER R**

- LED safety light with 1 red LED
- anodized aluminium body
- ultralight and compact design
- incl. rubber ring for toolfree attachment
- incl. 2x CR-2032

0.311.471/7 black 001595



**HL-004**

- LED front light
- 3 white LEDs
- incl. 3x AAA batteries and bracket

0.710.356/7 black 001095

0.710.357/5 chrome 001095



**HL-004+**

- LED front light
- 3 white LEDs
- incl. 4x AAA batteries and stainless steel bracket

0.710.358/3 chrome 001295



**HL-005**

- LED front light
- 3 white LEDs
- incl. 3x AAA batteries and bracket

0.710.359/1 black 001095



**TL-009**

- LED rear light
- 3 red LEDs
- incl. 2x AA batteries

0.311.925/2 self-service package 000695





**POWERHOUSE HUB 1**

- with Center Lock mount
- hollow axle
- for 20"-29"
- 100mm installation width
- 405g

0.710.268/4 36 holes, black	012995
0.710.269/2 32 holes, black	012995
0.710.270/0 28 holes, black	012995
0.710.273/4 28 holes, silver	012995



**POWERHOUSE HUB 2**

- with 6-hole mount
- hollow axle
- for 20"-29"
- 100mm installation width
- 415g

0.710.274/2 36 holes, black	012995
0.710.277/5 36 holes, silver	012995
0.710.275/9 32 holes, black	012995
0.710.278/3 32 holes, silver	012995
0.710.276/7 28 holes, black	012995
0.710.279/1 28 holes, silver	012995



**POWERHOUSE HUB 3**

- for V-brake
- hollow axle
- for 20"-29"
- 100mm installation width
- 395g

0.710.283/3 36 holes, black	012995
0.710.286/6 36 holes, silver	012995
0.710.284/1 32 holes, black	012995
0.710.287/4 32 holes, silver	012995
0.710.285/8 28 holes, black	012995
0.710.288/2 28 holes, silver	012995



**POWERHOUSE HUB 1+**

- with Center Lock mount
- for 15mm thru axle
- for 20"-29"
- 100mm installation width
- 456g
- black

0.710.289/0 36 holes	016995
0.710.290/8 32 holes	016995
0.710.291/6 28 holes	016995



**POWERHOUSE HUB 2+**

- with 6-hole mount
- for 15mm thru axle
- for 20"-29"
- 100mm installation width
- 448g
- black

0.710.292/4 36 holes	016995
0.710.293/2 32 holes	016995
0.710.294/0 28 holes	016995





**POWERHOUSE HUB**

- axle adapter
- for converting the Powerhouse 1+ and 2+ dynamos

0.710.296/5 conversion kit from 15mm to 12mm thru axle	001395
0.710.295/7 conversion kit from 15mm thru axle to QR	001395



**POWERHOUSE PLUG**

- connecting plug
- suitable for Powerhouse and Shutter Precision

0.710.259/3 black	000595
-------------------	--------



**POWERHOUSE HUB QR**

- thru axle
- 110mm long

0.710.299/9 Ø 15mm, black	004495
0.710.298/1 Ø 12mm, black	004495



**POWERHOUSE HUB QR**

- QR axle

0.710.297/3 black	001095
-------------------	--------



**DL-120**

- dynamo, plastic housing
- 4 plug connectors(2+/2-)
- with overvoltage protection
- release button

0.310.902/2 left mount	000995
0.310.903/0 right mount	000995



**DL-150**

- dynamo, aluminium housing
- 2 plug connectors (1+/1-)
- with overvoltage protector
- release button

0.310.905/5 self-service package, left mount	000995
0.310.410/6 bulk, left mount	000895
0.310.906/3 self-service package, right mount	000995
0.310.411/4 bulk, right mount	000895



**DYNAMO CAP**

- protects against dynamo slipping
- fits for all dynamo types
- PVC

0.310.901/4 black	000295
-------------------	--------

**2**  
PIECES



**CAP**

- set with 2 pieces
- for AXA HR Traction

0.310.179/7 black, for AXA HR Traction	000495
--	--------

**2**  
PIECES



**FLEXION**

- set with 2 pieces
- incl. universal ratchet clamp to attach to the bike
- StVZO approved

0.310.004/8 white and red	000495
---------------------------	--------

**4**  
PIECES



**CSR-100**

- spoke reflector
- non-looseable
- fits for all current spokes
- set with 4 pieces

0.311.946/8 self-service package	000495
0.311.646/4 bulk	000495

**36**  
PIECES

**72**  
PIECES



**CLIP R**

- more visibility in traffic and in darkness
- suitable for spoke Ø from 1,8 - 2,00mm
- toolfree assembly
- reflective silver

0.311.235/6 set with 36 pieces	001195
0.311.236/4 set with 72 pieces	002195



#### DIAMETER

Diameter of the handlebar clamp. The diameter of the clamping area must match that the handlebar and stem fit together.



#### LENGTH

Indicates the length of the stem or handlebar.



#### ANGLE

Angle between handlebar and steering tube defined through the stem.



## STEMS AND HANDLEBARS

# The Power Duo for ergonomic cycling

Whether aerodynamic, comfortable or unyielding – at CONTEC you will find a wide range of handlebars and stems with different features that are suitable for your individual riding style. To adjust the cockpit of

your bike ideally to you, we have divided our handlebars into the three categories "Sport", "Active" and "Relaxed".



SPORT

**Sport:** forward stretched posture, e.g. on MTB or road bike – The back is at a 45 degree and less angle.



ACTIVE

**Active:** slightly bent forward posture, e.g. on a trekking bike – The back is at a 60 degree angle to the road



RELAXED

**Relaxed:** upright posture, e.g. on city bike or Dutch bike – The back is at a 90 degree angle to the road.

Apart from the ergonomic aspects, your bike front can also be optimized stylishly: Our handlebar and stem series "Kyandi" and "Brut" bring a lot of flavor to your next tour.



KYANDI MOCHI P.34



KYANDI YOKAN P.41



# Steady on the road

Our stems for the E-MTB and MTB are made to get dirty. In the "Mesa", "Sedona" and "Taos" family you will find the right counterpart for almost every handlebar. All items have one thing in common: they safely bring you through the next trail with an optimal stiffness-to-weight ratio.



## MESA

- 1 1/8" ahead stem
- Ø 31,8mm
- aluminium 6061
- sandblasted black
- approx. 120g (35mm)

0.816.658/9 35mm long	005995
0.816.659/7 45mm long	005995

## MESA 35

- 1 1/8" ahead stem
- Ø 35,0mm
- aluminium 6061
- sandblasted black
- approx. 120g (35mm)

0.816.656/3 35mm long	005995
0.816.657/1 45mm long	005995



## SEDONA

- 1 1/8" ahead stem
- Ø 31,8mm
- aluminium 6061
- sandblasted black
- approx. 200g (40mm)

0.816.662/1 40mm long	002995
0.816.663/9 50mm long	002995



## SEDONA 35

- 1 1/8" ahead stem
- Ø 35,0mm
- aluminium 6061
- sandblasted black
- approx. 200g (40mm)

0.816.660/5 40mm long	002995
0.816.661/3 50mm long	002995

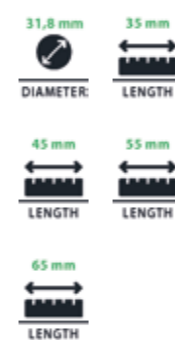

## TAOS

- 1 1/8" ahead stem
- Ø 31,8mm
- aluminium 6061
- sandblasted black
- 140g (35mm)

0.816.668/8 35mm long	002995
0.816.669/6 45mm long	002995
0.816.670/4 55mm long	002995
0.816.671/2 65mm long	002995

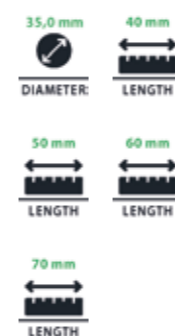

## TAOS 35

- 1 1/8" ahead stem
- Ø 35,0mm
- aluminium 6061
- sandblasted black
- 146g (40mm)

0.816.664/7 40mm long	002995
0.816.665/4 50mm long	002995
0.816.666/2 60mm long	002995
0.816.667/0 70mm long	002995

# Colorful variety

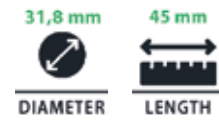

## KYANDI MOCHI

- 1 1/8" ahead stem
- 31,8mm handlebar clamp
- 45mm long
- aluminium 6061
- approx. 140g

0.816.804/9 aoi / black	002995
0.816.805/6 aka / black	002995
0.816.806/4 gure / black	002995
0.816.807/2 midori / black	002995



## UEDA FIX

- 1 1/8" ahead stem
- Ø 31,8mm
- angle +30°
- aluminium 6061
- sandblasted black
- approx. 270g (70mm)

0.816.617/5 70mm long	004995
0.816.618/3 90mm long	004995
0.816.619/1 110mm long	004495

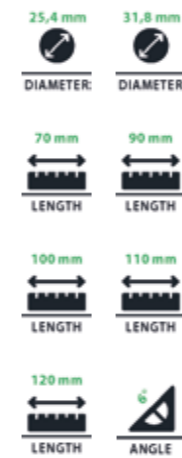

## FORGE

- 1 1/8" ahead stem
- angle +/- 6°
- aluminium 6061
- sandblasted black
- ca. 130g (25,4 x 70mm)

0.816.677/9 70mm long, 25,4mm handlebar clamp	002495
0.816.678/7 90mm long, 25,4mm handlebar clamp	002495
0.816.679/5 100mm long, 25,4mm handlebar clamp	002495
0.816.680/3 110mm long, 25,4mm handlebar clamp	002495
0.816.681/1 120mm long, 25,4mm handlebar clamp	002495
0.816.672/0 70mm long, 31,8mm handlebar clamp	002495
0.816.673/8 90mm long, 31,8mm handlebar clamp	002495
0.816.674/6 100mm long, 31,8mm handlebar clamp	002495
0.816.675/3 110mm long, 31,8mm handlebar clamp	002495
0.816.676/1 120mm long, 31,8mm handlebar clamp	002495



## FORGE MR

- 1 1/8" ahead stem
- handlebar clamp Ø 31,8mm
- angle +/- 17°
- aluminium 6061
- sandblasted black
- approx. 130g (70mm)

0.816.682/9 70mm long	002495
0.816.683/7 90mm long	002495
0.816.684/5 110mm long	002495



## FORGE HR

- 1 1/8" ahead stem
- angle +/- 35°
- aluminium 6061
- sandblasted black
- approx. 130g (25,4 x 70mm)

0.816.688/6 70mm long, 25,4mm handlebar clamp	002495
0.816.689/4 90mm long, 25,4mm handlebar clamp	002495
0.816.690/2 110mm long, 25,4mm handlebar clamp	002495
0.816.685/2 70mm long, 31,8mm handlebar clamp	002495
0.816.686/0 90mm long, 31,8mm handlebar clamp	002495
0.816.687/8 110mm long, 31,8mm handlebar clamp	002495

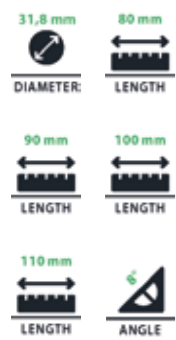

**BOREAL**

- 1 1/8" ahead stem
- Ø 31,8mm
- angle +/- 8°
- aluminium 6061
- matt black
- 200g (110mm)

0.816.777/7 80mm long	003995
0.816.778/5 90mm long	003995
0.816.779/3 100mm long	003995
0.816.780/1 110mm long	003995

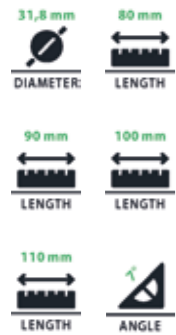

**SALAMANCA**

- 1 1/8" ahead stem
- handlebar clamp 31,8mm
- angle +/- 7°
- aluminium 6061
- matt black
- 134g (90mm)

0.816.784/3 80mm long	002995
0.816.785/0 90mm long	002995
0.816.786/8 100mm long	002995
0.816.787/6 110mm long	002995



**BRUT SELECT**

- 1 1/8" ahead stem
- handlebar clamp Ø 31,8mm
- 70mm long
- +/- 6° angle
- divisible handlebar clamp
- cold forged aluminium 6061
- stainless steel clamping bolts
- approx. 130g

0.716.982/4 rocket silver	002995
0.716.983/2 honky white	002995
0.716.984/0 limousine black	002995
0.716.985/7 blue steel	002995
0.716.986/5 riot red	002995
0.716.988/1 ultra violet	002995
0.716.989/9 guerilla green	002995
0.716.990/7 odd orange	002995



# Transformation for you and your bike



Adjustable stems offer you the perfect opportunity to adjust your steering center to your needs.

Because for different tours and riding styles, your body needs components which are aligned to ride particularly ergonomic.



**UEDA**

- 1 1/8" ahead stem
- adjustable: -40° to +40°
- aluminium 6061
- sandblasted black
- approx. 260g (25,4 x 90mm)

0.816.606/8 90mm long, 25,4mm handlebar clamp	003995
0.816.607/6 100mm long, 25,4mm handlebar clamp	003995
0.816.608/4 110mm long, 25,4mm handlebar clamp	003995
0.816.603/5 90mm long, 31,8mm handlebar clamp	003995
0.816.604/3 100mm long, 31,8mm handlebar clamp	003995
0.816.605/0 110mm long, 31,8mm handlebar clamp	003995
0.816.600/1 90mm long, 35,0mm handlebar clamp	003995
0.816.601/9 100mm long, 35,0mm handlebar clamp	003995
0.816.602/7 110mm long, 35,0mm handlebar clamp	003995

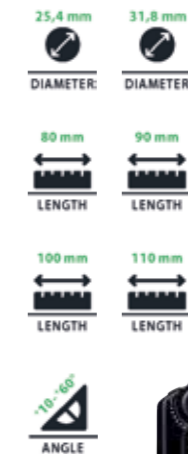

**UEDA HYBRID**

- 1 1/8" ahead stem
- adjustable: -40° to +60°
- aluminium 6061
- sandblasted black
- approx. 320g (25,4 x 90mm)

0.816.613/4 80mm long, 25,4mm handlebar clamp	003995
0.816.614/2 90mm long, 25,4mm handlebar clamp	003995
0.816.615/9 100mm long, 25,4mm handlebar clamp	003995
0.816.616/7 110mm long, 25,4mm handlebar clamp	003995
0.816.609/2 80mm long, 31,8mm handlebar clamp	003995
0.816.610/0 90mm long, 31,8mm handlebar clamp	003995
0.816.611/8 100mm long, 31,8mm handlebar clamp	003995
0.816.612/6 110mm long, 31,8mm handlebar clamp	003995





**SETO**

- 1 1/8" ahead stem
- adjustable: -30° to +40°
- aluminium 6061
- sandblasted black
- approx. 270g (25,4 x 90mm)

0.816.622/5 90mm long, 25,4mm handlebar clamp	002995
0.816.623/3 110mm long, 25,4mm handlebar clamp	002995
0.816.620/9 90mm long, 31,8mm handlebar clamp	002995
0.816.621/7 110mm long, 31,8mm handlebar clamp	002995



**SETO HYBRID**

- 1 1/8" ahead stem
- adjustable: -10° to +60°
- aluminium 6061
- sandblasted black
- approx. 300g (25,4 x 80mm)

0.816.626/6 80mm long, 25,4mm handlebar clamp	003495
0.816.627/4 110mm long, 25,4mm handlebar clamp	003495
0.816.624/1 80mm long, 31,8mm handlebar clamp	003495
0.816.625/8 110mm long, 31,8mm handlebar clamp	003495



**SETO STICK**

- 180mm shaft length
- adjustable: +30° to +70°
- aluminium 6061
- sandblasted black
- approx. 430g (25,4 x 75mm)

0.816.634/0 Ø 22,2mm, 75mm stem length, 25,4mm handlebar clamp	003495
0.816.635/7 Ø 22,2mm, 95mm stem length, 25,4mm handlebar clamp	003495
0.816.636/5 Ø 22,2mm, 105mm stem length, 25,4mm handlebar clamp	003495
0.816.637/3 Ø 25,4mm, 75mm stem length, 25,4mm handlebar clamp	003495
0.816.638/1 Ø 25,4mm, 95mm stem length, 25,4mm handlebar clamp	003495
0.816.639/9 Ø 25,4mm, 105mm stem length, 25,4mm handlebar clamp	003495
0.816.628/2 Ø 22,2mm, 75mm stem length, 31,8mm handlebar clamp	003495
0.816.629/0 Ø 22,2mm, 95mm stem length, 31,8mm handlebar clamp	003495
0.816.630/8 Ø 22,2mm, 105mm stem length, 31,8mm handlebar clamp	003495
0.816.631/6 Ø 25,4mm, 75mm stem length, 31,8mm handlebar clamp	003495
0.816.632/4 Ø 25,4mm, 95mm stem length, 31,8mm handlebar clamp	003495
0.816.633/2 Ø 25,4mm, 105mm stem length, 31,8mm handlebar clamp	003495



**LIDA**

- 1 1/8" ahead stem
- adjustable: 0° to +60°
- aluminium 6061
- sandblasted black
- approx. 250g (25,4 x 95mm)

0.816.643/1 95mm long, 25,4mm handlebar clamp	002795
0.816.644/9 95mm long, 25,4mm handlebar clamp	002795
0.816.645/6 130mm long, 25,4mm handlebar clamp	002795
0.816.640/7 95mm long, 31,8mm handlebar clamp	002795
0.816.641/5 110mm long, 31,8mm handlebar clamp	002795
0.816.642/3 125mm long, 31,8mm handlebar clamp	002795



**LIDA HYBRID**

- 1 1/8" ahead stem
- adjustable: 0° to +90°
- aluminium 6061
- sandblasted black
- approx. 370g (25,4 x 90mm)

0.816.648/0 90mm long, 25,4mm handlebar clamp	002995
0.816.649/8 110mm long, 25,4mm handlebar clamp	002995
0.816.646/4 90mm long, 31,8mm handlebar clamp	002995
0.816.647/2 110mm long, 31,8mm handlebar clamp	002995



**LIDA STICK**

- 180mm shaft length
- adjustable: 0° to +60°
- aluminium 6061
- sandblasted black
- approx. 440g (25,4 x 85mm)

0.816.653/0 85mm stem length, 25,4mm handlebar clamp	002995
0.816.654/8 100mm stem length, 25,4mm handlebar clamp	002995
0.816.655/5 120mm stem length, 25,4mm handlebar clamp	002995
0.816.650/6 85mm stem length, 31,8mm handlebar clamp	002995
0.816.651/4 100mm stem length, 31,8mm handlebar clamp	002995
0.816.652/2 115mm stem length, 31,8mm handlebar clamp	002995



**COBRA**

- 1 1/8" ahead stem
- 3D forged aluminium 6061
- adjustment: joint 1: -40° to +80°
- adjustment: joint 2: -50° to +50°
- divisible handlebar clamp
- in zero position 100mm long
- black
- approx. 300g (25,4 x 100mm)

0.316.738/4 25,4mm handlebar clamp, black	004995
0.316.739/2 31,8mm handlebar clamp, black	004995



**TARANTULA**

- 1 1/8" ahead stem
- cold forged aluminium 6061
- adjustable: -30° to +40°
- divisible handlebar clamp
- approx. 310g (25,4 x 90mm)

0.316.700/4 90mm long, 25,4mm handlebar clamp, black	002995
0.316.701/2 90mm long, 25,4mm handlebar clamp, silver	002995
0.316.704/6 110mm long, 25,4mm handlebar clamp, black	002995
0.316.702/0 90mm long, 31,8mm handlebar clamp, black	002995
0.316.703/8 90mm long, 31,8mm handlebar clamp, silver	002995
0.316.706/1 110mm long, 31,8mm handlebar clamp, black	002995
0.316.707/9 110mm long, 31,8mm handlebar clamp, silver	002995



**Proper eye candy**



**KYANDI YOKAN**

- Ø 31,8mm
- grip width 760mm
- backsweep 7°
- rise 10mm
- aluminium 7050
- approx. 330g

0.816.800/7 aoi / black	004995
0.816.801/5 aka / black	004995
0.816.802/3 gure / black	004995
0.816.803/1 midori / black	004995

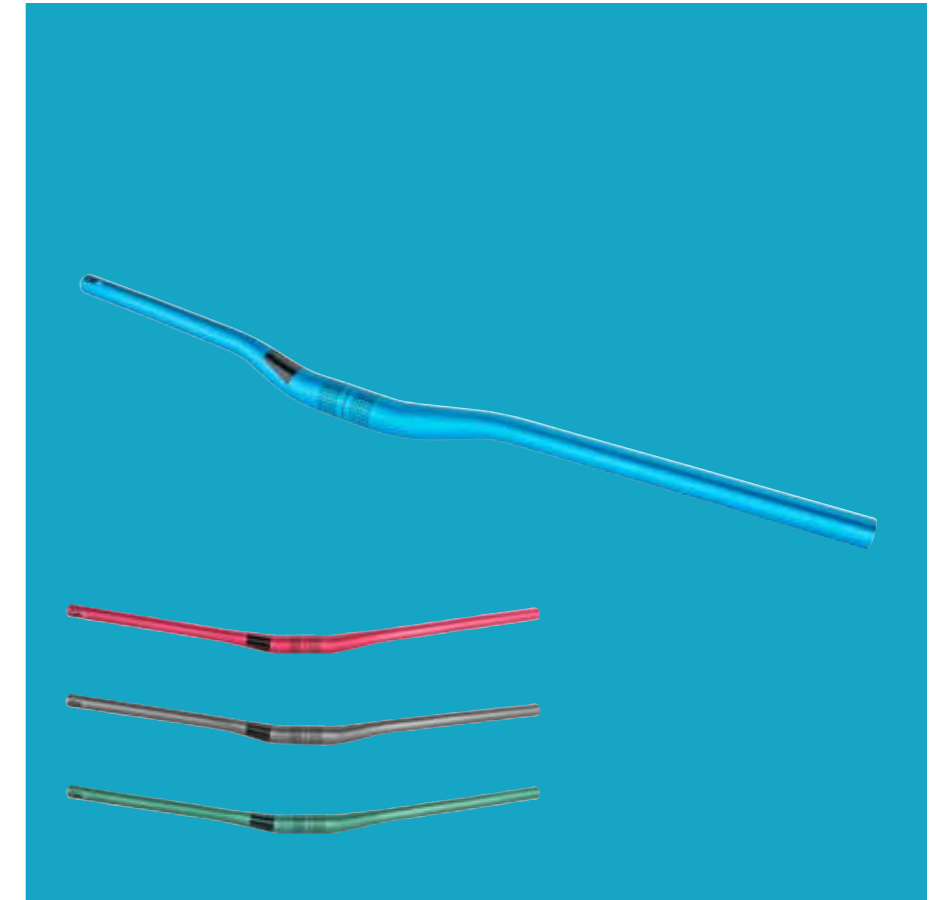

**VERTIGO**

- Ø 31,8mm
- backsweep 7°
- riser
- aluminium 7050
- sandblasted black
- approx. 330g (740mm)

0.816.697/7 grip width: 740mm, rise 10mm	004995
0.816.698/5 grip width: 760mm, rise 10mm	004995
0.816.699/3 grip width: 780mm, rise 10mm	004995
0.816.700/9 grip width: 740mm, rise 20mm	004995
0.816.701/7 grip width: 760mm, rise 20mm	004995
0.816.702/5 grip width: 780mm, rise 20mm	004995
0.816.703/3 grip width: 740mm, rise 30mm	004995
0.816.704/1 grip width: 760mm, rise 30mm	004995
0.816.705/8 grip width: 780mm, rise 30mm	004995

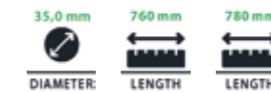

**VERTIGO 35**

- Ø 35,0mm
- riser
- aluminium 7050
- sandblasted black
- approx. 316g (760mm)

0.816.691/0 grip width: 760mm, rise: 15mm, backsweep 7°	004995
0.816.692/8 grip width: 780mm, rise 15mm, backsweep 7°	004995
0.816.693/6 grip width: 760mm, rise 25mm, backsweep 7°	004995
0.816.694/4 grip width: 780mm, rise 25mm, backsweep 7°	004995
0.816.695/1 grip width: 760mm, rise 35mm, backsweep 8°	004995
0.816.696/9 grip width: 780mm, rise 35mm, backsweep 8°	004995



**SENDAI 45**

- backsweep 15°
- rise 5mm
- aluminium 6061
- sandblasted black
- approx. 288g (630mm)

0.816.748/8 Ø 25,4mm, grip width: 630mm	003495
0.816.749/6 Ø 25,4mm, grip width: 660mm	003495
0.816.746/2 Ø 31,8mm, grip width: 630mm	003495
0.816.747/0 Ø 31,8mm, grip width: 660mm	003495



**SENDAI 60**

- Ø 31,8mm
- aluminium 6061
- sandblasted black
- approx. 264g (630mm)

0.816.744/7 grip width: 630mm, rise: 17mm, backsweep 15°	003495
0.816.745/4 grip width: 660mm, rise: 21mm, backsweep 35°	003495



**SENDAI 90**

- Ø 31,8mm
- backsweep 41°
- rise 34mm
- aluminium 6061
- sandblasted black
- approx. 322g (630mm)

0.816.742/1 grip width: 630mm	003995
0.816.743/9 grip width: 660mm	003995



**PORTAL**

- Ø 31,8mm
- backsweep 9°
- riser
- aluminium 6061
- sandblasted black
- approx. 356g (720mm)

0.816.712/4 grip width: 720mm, rise 15mm	003495
0.816.713/2 grip width: 740mm, rise 15mm	003495
0.816.714/0 grip width: 760mm, rise 15mm	003495
0.816.715/7 grip width: 780mm, rise 15mm	003495
0.816.716/5 grip width: 720mm, rise 30mm	003495
0.816.717/3 grip width: 740mm, rise 30mm	003495
0.816.718/1 grip width: 760mm, rise 30mm	003495
0.816.719/9 grip width: 780mm, rise 30mm	003495



**PORTAL**

- Ø 35,0mm
- riser
- aluminium 6061
- sandblasted black
- approx. 328g (740mm)

0.816.706/6 grip width: 740mm, rise 20mm, backsweep 9°	003495
0.816.707/4 grip width: 760mm, rise 20mm, backsweep 9°	003495
0.816.708/2 grip width: 780mm, rise 20mm, backsweep 9°	003495
0.816.709/0 grip width: 740mm, rise 30mm, backsweep 8°	003495
0.816.710/8 grip width: 760mm, rise 30mm, backsweep 8°	003495
0.816.711/6 grip width: 780mm, rise 30mm, backsweep 8°	003495

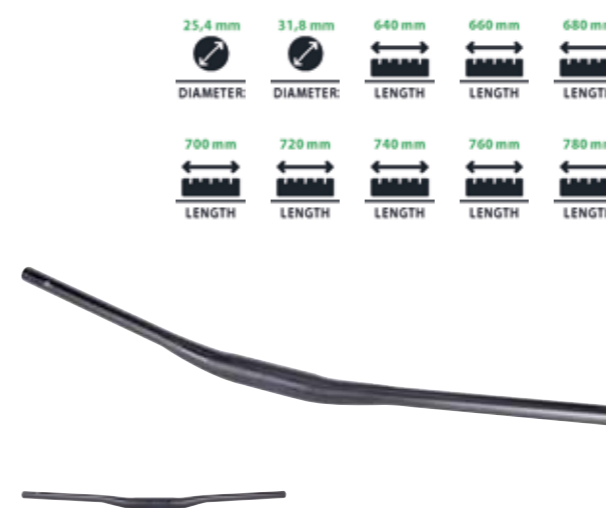

**MOAB**

- riser
- aluminium 6061
- sandblasted black
- approx. 350g (640mm)

0.816.732/2 Ø 25,4mm, grip width: 640mm, rise 25mm, backsweep 8°	002995
0.816.733/0 Ø 25,4mm, grip width: 660mm, rise 25mm, backsweep 8°	002995
0.816.734/8 Ø 25,4mm, grip width: 680mm, rise 25mm, backsweep 8°	002995
0.816.724/9 Ø 31,8mm, grip width: 700mm, rise 15mm, backsweep 9°	002995
0.816.725/6 Ø 31,8mm, grip width: 720mm, rise 15mm, backsweep 9°	002995
0.816.726/4 Ø 31,8mm, grip width: 740mm, rise 15mm, backsweep 9°	002995
0.816.727/2 Ø 31,8mm, grip width: 700mm, rise 25mm, backsweep 9°	002995
0.816.728/0 Ø 31,8mm, grip width: 720mm, rise 25mm, backsweep 9°	002995
0.816.729/8 Ø 31,8mm, grip width: 740mm, rise 25mm, backsweep 9°	002995
0.816.730/6 Ø 31,8mm, grip width: 760mm, rise 25mm, backsweep 9°	002995
0.816.731/4 Ø 31,8mm, grip width: 780mm, rise 25mm, backsweep 9°	002995



**MOAB FLAT**

- Ø 31,8mm
- rise 0
- backsweep 5°
- flatbar
- aluminium 6061
- sandblasted black
- approx. 246g (660mm)

0.816.738/9 grip width: 660mm	002995
0.816.739/7 grip width: 680mm	002995
0.816.740/5 grip width: 700mm	002995
0.816.741/3 grip width: 720mm	002995





**MOAB 35**

- Ø 35,0mm
- backsweep 9°
- rise 15mm
- aluminium 6061
- sandblasted black
- approx. 326g (720mm)

0.816.720/7	grip width: 720mm	002995
0.816.721/5	grip width: 740mm	002995
0.816.722/3	grip width: 760mm	002995
0.816.723/1	grip width: 780mm	002995



**MOAB 35 FLAT**

- Ø 35,0mm
- rise 0
- backsweep 5°
- flatbar
- aluminium 6061
- sandblasted black
- approx. 298g (680mm)

0.816.735/5	grip width: 680mm	002995
0.816.736/3	grip width: 700mm	002995
0.816.737/1	grip width: 720mm	002995



**MITO 45**

- rise 0
- backsweep 5°
- aluminium 6061
- sandblasted black
- approx. 282g (560mm)

0.816.771/0	Ø 25,4mm, grip width: 560mm	001995
0.816.772/8	Ø 25,4mm, grip width: 580mm	001995
0.816.773/6	Ø 25,4mm, grip width: 600mm	001995
0.816.768/6	Ø 31,8mm, grip width: 560mm	001995
0.816.769/4	Ø 31,8mm, grip width: 580mm	001995
0.816.770/2	Ø 31,8mm, grip width: 600mm	001995

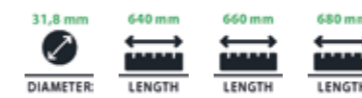

**MITO 60**

- Ø 31,8 mm
- rise 15mm
- aluminium 6061
- sandblasted black
- approx. 260g (640mm)

0.816.756/1	grip width: 640mm, backsweep 15°	002995
0.816.757/9	grip width: 660mm, backsweep 15°	002995
0.816.758/7	grip width: 680mm, backsweep 15°	002995
0.816.759/5	grip width: 640mm, backsweep 25°	002995
0.816.760/3	grip width: 660mm, backsweep 25°	002995
0.816.761/1	grip width: 680mm, backsweep 25°	002995

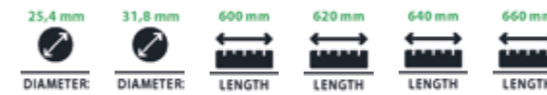

**MITO 90**

- backsweep 37°
- rise 28mm
- aluminium 6061
- sandblasted black
- approx. 286g (600mm)

0.816.753/8	Ø 25,4mm, grip width: 600mm	002995
0.816.754/6	Ø 25,4mm, grip width: 620mm	002995
0.816.755/3	Ø 25,4mm, grip width: 640mm	002995
0.816.750/4	Ø 31,8mm, grip width: 620mm	002995
0.816.751/2	Ø 31,8mm, grip width: 640mm	002995
0.816.752/0	Ø 31,8mm, grip width: 660mm	002995



**BRUT EXTRA SELECT**

- lowriser
- double butted aluminium 6061
- 9° backsweep / 5° upsweep
- rise: 15mm
- 31,8 x 780mm
- approx. 350g

0.716.903/0 rocket silver	003995
0.716.904/8 honky white	003995
0.716.906/3 blue steel	003995
0.716.907/1 riot red	003995
0.716.908/9 heart of gold	003995
0.716.909/7 ultra violet	003995
0.716.910/5 guerilla green	003995
0.716.911/3 odd orange	003995

**BRUT SELECT**

- highriser
- double butted aluminium 6061
- 9° backsweep / 5° upsweep
- rise: 30mm
- 31,8 x 720mm
- approx. 340g

0.716.991/5 rocket silver	003495
0.716.992/3 honky white	003495
0.716.994/9 blue steel	003495
0.716.995/6 riot red	003495
0.716.997/2 ultra violet	003495
0.716.998/0 guerilla green	003495
0.716.999/8 odd orange	003495



**MENDOZA**

- gravel handlebar
- Ø 31,8mm
- drop 125mm
- reach 70mm
- flare 12°
- aluminium 6061
- sandblasted black

0.816.781/9 400mm	002995
0.816.782/7 420mm	002995
0.816.783/5 440mm	002995



**AUSTRAL**

- gravel handlebar
- Ø 31,8mm
- drop 130mm
- reach 75mm
- flare 12°
- aluminium 6061
- sandblasted black

0.816.774/4 400mm	004995
0.816.775/1 420mm	004995
0.816.776/9 440mm	004995



**TRI BAR**

- triathlon / time trial bar
- 25,4 x 350mm
- soft arm paddin
- aluminium 6061 T6
- approx. 660g

0.316.922/4 black	002995
-------------------	--------



**LITE BAR**

- ergonomic design
- length: 120mm
- 240g / pair

0.316.913/3 black 002195



**TRIANGLE**

- ergonomic design
- length: 90mm
- approx. 180g / pair

0.316.915/8 black 001995



**COMFORT XXL**

- larger grip Ø (28,6mm) for comfortable driving
- length: 140mm
- approx. 130g / pair

0.316.910/9 black 001795



**ERGO LINE**

- aluminium core with Kraton rubber on surface
- for comfortable riding
- length: 125mm
- 140g / pair

0.316.909/1 black 001795



**HEADS-UP SPIN**

- steering tube extension for 1 1/8" headset forks
- incl. 4 spacers with 5mm
- with spin function for toolless rotation of the stem up to 90°
- aluminium 6061
- 250g

0.716.229/0 black 004995



**HEADS-UP DLX**

- steering tube extension for 1 1/8" ahead set-fork with aluminium or steel shaft
- incl. 5 spacers for height adjustment, headset-star (1x8mm; 4x5mm), screw and cap
- 3D forged aluminium 6061
- 190g

0.316.907/5 black 002995

0.316.908/3 silver 002995



**HEADS-UP**

- steering tube extension for 1 1/8" ahead set forks
- for comfortable riding
- incl. 4 spacers for height adjusting (1x 10 mm; 1x 8mm; 2x 5mm)
- aluminium 6061
- 220g

0.316.975/2 black 002495

0.316.976/0 silver 002495



**STEERING STABILIZER**

- prevents uncontrolled swinging of the front wheel in use with double leg kick stand
- complete set

0.316.926/5 for frame Ø 28 up to 32mm 000995

0.316.929/9 for frame Ø 38 up to 62mm 000995



**HANDLEBAR PLUGS**

- made of plastic, with fixed screw
- pair

0.316.927/3 black 000495





# BRAKES



## Stop!

Not everything has to stay as it is. Because with the brakes on your bike is not to be trifled with if they no longer work properly, it is time to replace the wearing parts. In the CONTEC range you will find a wide selection of cables, disc pads, rotors or rim brake pads. For bicycle repair shops, many wear parts are

also available in bulk to reduce packaging waste. Our various brake levers offer you not only a large portion of safety, but are also a way to visually enhance your handlebar.



DISC STOP HOSE P.81

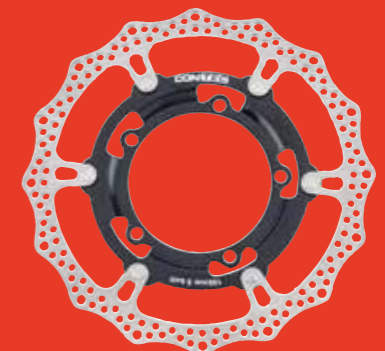

CDR-5B P.73



**BR-RD10**

- side-pull brake
- cold forged aluminium
- dual pivot caliper or brake caliper
- dimensions: 39-51mm
- 165g

0.307.828/4 set: right and left 006495



**BL-RD10**

- V-brake, road brake
- cold forged aluminium
- integrated quick release mechanism
- black
- 272g / pair

0.307.820/1 set: right and left 003495



**BL-CX10**

- addition brake lever Cantilever, for cyclocross and touring bikes
- aluminium
- Top Mount, clamp Ø 24mm
- grip width adjustment
- black / silver
- 90g / pair

0.307.817/7 set: right and left 002995



**BL-CX11**

- addition brake lever Cantilever, for cyclocross and touring bikes
- aluminium
- Top Mount, clamp Ø 31,8mm
- grip width adjustment
- black / silver
- 90g / pair

0.307.832/6 set: right and left 002995



**BL-US3F**

- for Cantilever and side-pull brakes
- aluminium
- 3-finger lever
- for inner cables with pear nipple
- 168g / pair

0.307.860/7 silver / black, right 001995

0.307.861/5 silver / black, left 001995

0.307.862/3 black / black, right 001995

0.307.863/1 black / black, left 001995



**BL-US2F**

- for Cantilever and side-pull brakes
- aluminium
- 2-finger lever
- for inner cables with pear nipple
- 178g / pair

0.307.864/9 silver / black, right 001995

0.307.865/6 silver / black, left 001995

0.307.866/4 black / black, right 001995

0.307.867/2 black / black, left 001995



**BR-MT10**

- V-brake, MTB
- cold forged aluminium
- brake shoes - 63mm
- joint length: 102mm
- incl. cable guide and screws
- 156g

0.307.803/7 black 002195

0.307.804/5 silver 002195



**BR-BX930**

- V-brake, BMX
- aluminium - cold forged
- joint length: 95mm
- incl. cable guide and screws
- 166g

0.307.034/9 black 002695



**BL-MT30**

- V-brake, MTB
- aluminium
- 2-finger lever
- suitable for RapidFire shift lever
- black / silver
- 180g / pair

0.307.813/6 right 001395

0.307.814/4 left 001395





**BL-MT10**

- V-brake, MTB
- aluminium
- 2-finger lever
- suitable for RapidFire shift lever
- black / silver matt
- 180g / pair

0.307.825/0 right	001295
0.307.826/8 left	001295



**BL-MT20 TWIST**

- V-brake, MTB
- aluminium
- 3-finger lever
- also suitable for twist grip shift lever
- silver / black
- 196g / pair

0.307.823/5 right	001195
0.307.824/3 left	001195



**BR-CR10**

- V-brake, comfort
- cold forged aluminium
- brake shoes - 55mm
- joint length: 120mm (especially good for large volumen tires)
- incl. cable guide and screws
- 166g

0.307.800/3 silver	001695
--------------------	--------



**BR-CT10**

- V-brake, city / trekking
- cold forged aluminium
- brake shoes - 63mm
- joint length: 110mm
- incl. cable guide and screws
- 161g

0.307.805/2 black	002195
0.307.806/0 silver	002195



**BL-CT10**

- V-brake, comfort
- aluminium
- 4-finger lever with Kraton rubber inserts
- suitable for RapidFire shift lever
- black / silver matt
- 204g / pair

0.307.815/1 right	001295
0.307.816/9 left	001295



**BL-CT10 TWIST**

- V-brake, comfort
- aluminium
- 4-finger lever with Kraton rubber inserts
- also suitable for twist grip shift lever
- black / silver
- 204g / pair

0.307.821/9 right	001295
0.307.822/7 left	001295



**BL-CT20 TWIST**

- V-brake, comfort
- aluminium
- 4-finger lever
- also suitable for twist grip shift lever
- silver
- 184g / pair

0.307.811/0 right	001195
0.307.812/8 left	001195





**BR-CL15**

- side-pull brake, comfort
- aluminium
- dual pivot caliper or brake caliper
- dimensions: 61-78mm

0.307.841/7 front	002195
0.307.842/5 rear, for ESGE-/Pletscher mount	002195



**BR-CL20**

- side-pull brake, comfort
- aluminium
- dual pivot caliper or brake caliper
- dimensions: 72-92mm
- 200g

0.307.845/8 front, bulk	000000
0.307.831/8 front	002195



**BL-CL RETRO**

- for Cantilever, roller and side-pull brake
- aluminium
- 4-finger
- silver
- 180g / pair

0.307.837/5 right	001595
0.307.838/3 left	001595



**BR-KY10**

- V-brake, children / youth
- cold forged aluminium
- brake shoes - 55mm
- joint length: 95mm
- incl. cable guide and screws
- 155g

0.307.827/6 black	001495
-------------------	--------



**BL-K10**

- V-brake, kids brake lever 16-20"
- cold forged aluminium
- 4-finger safety lever
- also suitable for twist grip shift lever
- black / silver
- 180g / pair

0.307.807/8 right	001195
0.307.808/6 left	001195



**BL-K20**

- V-brake, children brake lever 12-16"
- cold forged aluminium
- 3-finger lever
- also suitable for twist shifter
- black / silver
- 109g / pair

0.307.829/2 right	001395
-------------------	--------



**BL-Y10**

- V-brake, kids brake lever 20-24"
- cold forged aluminium
- 3-finger lever
- also suitable for twist grip shift lever
- black / silver
- 182g / pair

0.307.809/4 right	001195
0.307.810/2 left	001195



**R-STOP**

- for side and centre-pull brakes
- medium compound
- cartridge
- 55mm
- pair

0.307.932/4 black	001095
0.307.933/2 silver	001095



**R-STOP +**

- for side and centre-pull brakes
- alloy plus compound
- 55mm
- pair

0.307.931/6 black / blue	000895
--------------------------	--------

**25**  
PAIR



**R-STOP**

- for side and centre-pull brakes
- medium compound
- 55mm
- black

0.307.930/8 self-service package	000595
0.307.966/2 box with 25 pairs	014895



**R-STOP +**

- for side and centre-pull brakes
- alloy plus compound
- cartridge
- 55mm
- pair

0.307.934/0 black	001495
0.307.935/7 silver	001495



**R-STOP+**

- suitable for cartridge road brake shoes
- alloy plus compound
- 55mm
- pair

0.307.791/4 blue	000795
------------------	--------



**R-STOP**

- suitable for cartridge road brake shoes
- medium compound
- 55mm
- pair

0.307.789/8 black	000595
-------------------	--------

**25**  
PAIR



**V-STOP 3D**

- for V-brakes
- triple contour design
- medium compound
- cartridge
- 72mm

0.307.963/9 self-service package, black	001695
0.307.964/7 self-service package, silver	001695
0.307.965/4 box with 25 pairs	042395



**V-STOP 2D**

- for V-brakes
- dual contour design
- medium compound
- cartridge
- 72mm
- pair

0.307.962/1 black	001495
-------------------	--------



**V-STOP +**

- for V-brakes
- alloy plus compound
- cartridge
- asymmetric
- 70mm
- pair

0.307.960/5 black	001295
0.307.961/3 silver	001295



**V-STOP**

- for V-brakes
- medium compound
- cartridge
- asymmetric
- 70mm
- pair

0.307.958/9 black	001295
0.307.959/7 silver	001295

# Brake pads

Worn brake pads must be replaced to ensure the functionality of the rim brake. For different types of brakes exists different kinds of pads, e.g. for Cantilever, V-brakes or hydraulic rim brakes. The pads consists of different compounds, which have an influence on braking behaviour and durability. We offer many current pad types in a practical workshop box.

## Medium Compound

Medium-hard rubber compound for optimum braking deceleration and a minimum wear.

## Alloy Plus Compound

The new compound provides in all weather conditions a high and particularly controlled braking power.

## 2D Compound

Offers a high braking performance, even by wet conditions.

## 3D Compound

3 blocks = 3 functions  
The first block increases the braking performance in all weather conditions. The middle block cleans the rim and the last block avoids squeaking sounds.



## V-STOP 3D

- suitable for cartridge V-brake brake shoes
- 3D triple compound
- 72mm
- pair

0.307.798/9 black / green / brown 000995



## V-STOP 2D

- suitable for cartridge V-brake brake shoes
- 2D dual compound
- 72mm
- pair

0.307.797/1 black / grey 000895



## V-STOP+

- suitable for cartridge V-brake brake shoes
- alloy plus compound
- 70mm
- pair

0.307.795/5 blue 000795



## V-STOP

- suitable for cartridge V-brake brake shoes
- medium compound
- 70mm
- pair

0.307.793/0 black 000595



## V-STOP ABS

- for V-brakes
- ABS compound
- asymmetric
- 70mm
- black / orange / grey

0.307.957/1 pair 001095



## V-STOP +

- for V-brakes
- alloy plus compound
- asymmetric
- 70mm
- black / blue

0.307.956/3 pair 000895



## V-STOP 2D

- for V-brakes
- dual contour design
- medium compound
- asymmetric
- 72mm
- black / grey

0.307.955/5 pair 000995

25  
PAIR



## V-STOP

- for V-brakes
- medium compound
- symmetric
- 70mm
- black

0.307.945/6 threaded, pair 000595

0.307.946/4 threaded, 2 pairs 001095

0.307.947/2 threaded, box with 25 pairs 014895

0.307.948/0 post type, pair 000595

0.307.949/8 post type, box with 25 pairs 014895

25  
PAIR



## V-STOP

- for V-brakes
- medium compound
- asymmetric
- 70mm
- black

0.307.950/6 threaded, pair 000595

0.307.951/4 threaded, 2 pairs 001095

0.307.952/2 threaded, box with 25 pairs 014895

0.307.953/0 post type, pair 000595

0.307.954/8 post type, box with 25 pairs 014895



**20**  
PAIR



**C-STOP**

- for Cantilever brakes
- medium compound
- asymmetric
- 70mm
- black

0.307.942/3 pair	000495
0.307.943/1 box with 20 pairs	009995

**25**  
PAIR



**C-STOP**

- for Cantilever brakes
- medium compound
- symmetric
- 70mm
- black

0.307.940/7 pair	000495
0.307.941/5 box with 25 pairs	012395

**25**  
PAIR



**C-STOP**

- for Cantilever brakes
- medium compound
- 55mm
- black

0.307.938/1 pair	000495
0.307.939/9 box with 25 pairs	012395

**25**  
PAIR



**H-STOP +**

- for hydraulic brakes
- Alloy Plus compound
- suitable for Magura HS11 / HS22 / HS24 / HS33
- 55mm
- black / blue

0.307.929/0 pair	001795
------------------	--------

**H-STOP**

- for hydraulic brakes
- medium compound
- suitable for Magura HS11 / HS22 / HS24 / HS33
- 55mm
- black

0.307.936/5 pair	001395
0.307.937/3 box with 25 pairs	034895

# Disc pads

Our disc pads are available for the most popular brake models in the versions: organic, sintered or alloy. What pads you need depends on what and how you drive, because the brake pads have a decisive influence on the riding experience.

**ORGANIC**

Organic pads are made of organic material, which is bound together by a special resin. The advantages of organic pads are a shorter initial braking phase, immediate max performance, less noise and less heat absorption. The wear on the organic pads is higher. Therefore the pads are ideal for lighter drivers and for tours where you don't have to brake so often.

**ALLOY**

The compound of organic brake pad and a retaining plate made of aluminum is used for better heat transportation away from the pad and is a good compromise when it comes to the connection of the advantages of organic coatings and the heat resistance of the sintered pads. As a result, brake fading occurs later in the course of intensive use and creates reserves in long demanding descents or with frequent braking heavier riders.

**SINTERED**

Sintered pads are made of hardened metal components, which are connected with each other by heat and pressure. The advantages of sintered pads are higher temperature resistance and thus later-break fading, as well as better function in mud and wet conditions and less wear. The sintered brake pads are a little louder and will need a longer braking phase, but their performance makes them bloom especially when often braking. Therefore the ideal use is in downhill, for heavier riders but also for E-bikes and Spedelecs.

**COOL**

These organic pads equipped with cooling fins, offer even higher resistance to dreaded fading or glazing than our already very durable pads. The heat generated during braking is optimally dissipated via the cooling fins. An advantage that is worth at particularly long descents.

**WEAR INDICATOR**

The integrated indicator gives an acoustic sound when it's time to exchange the brake pads.



MAGURA



**DISCSTOP+ CBP-100**

·suitable for **Magura Louise** (-2001), **Clara** (-2000)

0.817.400/5 organic 001595

MAGURA

PROMAX



**DISCSTOP+ CBP-110**

·suitable for **Magura Clara** (ab 2001), **Louise FR** (-2006), **Louise** (2002-2006) - **Promax DSK-903**

0.817.401/3 organic 001595

MAGURA



**DISCSTOP+ CBP-130**

·suitable for **Magura Julie** (2001-2008), **Louise** (from 2007)

0.817.402/1 organic 001595  
0.817.465/8 organic, box with 25 pairs 001595

MAGURA



**DISCSTOP+ CBP-140**

·suitable for **Magura Marta** (-2008), **SL** (-2008), **Gold - Clarks Skeletal**

0.817.403/9 organic 001595

MAGURA



**DISCSTOP+ CBP-150**

·suitable for **Magura Louise** (2007-2010), **Julie HP** (2009)

0.817.404/7 organic 001595  
0.817.466/6 organic, box with 25 pairs 001595

MAGURA



**DISCSTOP+ CBP-160**

·suitable for **Magura MT 7 HC / Pro / raceline**, **MT 5 eStop / fabio wimber**, **MT Trail SL (front)**, **MT 1893, CT5**

0.817.405/4 CBP-160, organic 001595  
0.817.467/4 CBP-160, organic, box with 25 pairs 001595  
0.817.475/7 CBP-160A+, organic, with aluminium plate and aluminium PIN - 50% lighter, good heat transfer and performance 001795  
0.817.444/3 CBP-160 S, metal, sintered 001795  
0.817.097/9 CBP-160C, sintered metal, with cooling fins - 40% less wear 001995

MAGURA



**DISCSTOP+ CBP-170**

·suitable for **Magura MT 5 / e - MT Trail sport** (front)

0.817.406/2 CBP-170, organic 001595  
0.817.468/2 CBP-170, organic 001595  
0.817.445/0 CBP-170 S, metal, sintered 001795

HAYES



**DISCSTOP+ CBP-200**

·suitable for **Hayes HFX MAG / 9-series - MX 1 - Promax DSK-600**

0.817.407/0 CBP-200, organic 001595  
0.817.408/8 CBP-200S, metal, sintered 001795

HAYES

CANNONDALE

BENGAL



**DISCSTOP+ CBP-240**

·suitable for **Hayes MX-2/3/4/5 Sole - CX pro / comp / expert - QDH 4 / 5 SP - Cannondale Helix 6, Bengal ares, MB series / strida / Helix 1 - 7.5**

0.817.409/6 organic 001595

HAYES



**DISCSTOP+ CBP-250**

·suitable for **Hayes Stroker** / Graming

0.817.410/4 CBP-250, organic	001595
0.817.446/8 CBP-250 S, metal, sintered	001795

HAYES



**DISCSTOP+ CBP-260**

·suitable for **Hayes Ryde/Dyno**

0.817.411/2 organic	001595
---------------------	--------

HAYES



**DISCSTOP+ CBP-270**

·suitable for **Hayes Prime** / comp

0.817.412/0 organic	001595
---------------------	--------

HAYES

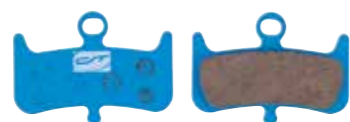

**DISCSTOP+ CBP-280**

·suitable for **Hayes Dominion A4** / SFL

0.817.461/7 CBP-280, organic	001595
------------------------------	--------

AVID

PROMAX

CLARKS



**DISCSTOP+ CBP-310**

·suitable for **Avid BB3 / BB5** mechanic - **Promax DSK 710 / 717 / 717R / 300 / 300R / 310 / 330 / 330R** - **Clarks CMD17**

0.817.413/8 CBP-310, organic	001595
0.817.447/6 CBP-310 S, metal, sintered	001795

AVID

PROMAX



**DISCSTOP+ CBP-320**

·suitable for **Avid Juicy Ultimate / 7 / Carbon / 5 - BB7 series, Promax DSK-905**

0.817.414/6 CBP-320, organic	001595
0.817.476/5 CBP-320A+, organic, with aluminium plate - 50% lighter, good heat transfer and performance	001795
0.817.448/4 CBP-320S, metal, sintered	001795

AVID



**DISCSTOP+ CBP-330**

·suitable for **Avid CODE** 4-piston

0.817.415/3 organic	001595
---------------------	--------

AVID

SRAM



**DISCSTOP+ CBP-340**

·suitable for **Avid Elixir Serie - Sram XX - XO, Red eTap - Trickstuff C21**

0.817.416/1 CBP-340, organic	001595
0.817.469/0 CBP-340, organic, box with 25 pairs	001595
0.817.477/3 CBP-340A+, organic, with aluminium plate and aluminium PIN - 50% lighter, good heat transfer and performance	001795
0.817.450/0 CBP-340S, metal, sintered	001795

AVID



**DISCSTOP+ CBP-350**

·suitable for **Avid X0 Trail - Elixir 7 / 9 / Trail 4-piston - Guide Ultimate / RSC / RS / R, Sram G2 Ultimate**

0.817.417/9 CBP-350, organic	001595
0.817.451/8 CBP-350 S, metal, sintered	001795

AVID



**DISCSTOP+ CBP-360**

·suitable for **Avid Code R** (ab 2011) / RSC, **Guide RE / DB8 / G2RE**

0.817.418/7 CBP-360, organic	001595
0.817.452/6 CBP-360 S, metal, sintered	001795



SRAM



**DISCSTOP+ CBP-370**

·suitable for **Sram Road RED / Force1 / CX1 / Force / Rival 1 / Rival 22 / S-700 / Level Ultimate / Level TLM, Hydro R**

0.817.419/5 CBP-370, organic	001595
0.817.478/1 CBP-370A+, organic, with aluminium plate and aluminium PIN - 50% lighter, good heat transfer and performance	001795
0.817.453/4 CBP-370 S, metal, sintered	001795

SRAM



**DISCSTOP+ CBP-380**

·suitable for **Sram DB 1/3/5 - Level T / TL / TLM / Ultimate / Force 2020**

0.817.420/3 CBP-380, organic	001595
0.817.420/4 CBP-380 S, metal, sintered	001795



**DISCSTOP+ CBP-500**

·suitable for **Shimano XT BR-M755, Grimeca system8, Sram 9.0, Hope Mono M4 / Tech, Trickstuff C41 / DIRET-TISSIMA, Promax DSK-922m / 922T / 930M / 930T**

0.817.421/1 organic	001595
---------------------	--------

SHIMANO



**DISCSTOP+ CBP-510**

·suitable for **Shimano Deore BR-M555**

0.817.422/9 organic	001595
---------------------	--------

SHIMANO

TEKTRO

PROMAX

ALHONGA



**DISCSTOP+ CBP-530**

·suitable for **Shimano Deore M575 / M525 / 515 / M505 / 495 / 486 / 485 / 475 / 465 / 447 / 446 / 445 / 416 / 416A / 415 / 4050 / 375 / 395 / 365 / 355 / 315 / 3050 / T615 / T675 / C501 / C601 / TX805 / MT500 / MT400 / R317 - TEKTRO HD r280 / T39 / J258, MD c400 / c510 / c550 - Auriga Pro / MD- U310f / u310r / M280 / M285 / M290 / M300 / M352 / C310r / C310f / C605 / C605slc / C550 slc / C610 / C610slc / 610C / C705 / 705C / C710 / 710C / C800 / C801 / C811 / M600 / M802, G-spec FMR R802 (hinten) / spyke / eu810 (hinten) / eu811 (hinten) - ALHONGA HJ-MD 17/18 - Promax dsk-927 / 927T / 936 / 923 / 925 / 926 / 920m / 920T / 718R**

0.817.424/5 CBP-530 MY2022, organic	001595
0.817.424/6 CBP-530, organic	001595
0.817.470/8 CBP-530 MY2022, organic, box with 25 pairs	001595
0.817.470/9 CBP-530, organic, box with 25 pairs	001595
0.817.481/5 CBP-530A+, organic, with aluminium plate - 50% lighter, good heat transfer and performance	001795
0.817.454/2 CBP-530 S, metal, sintered	001795
0.817.474/0 CBP-530 S, metal, sintered, box with 25 pairs	001795

SHIMANO

TRP



**DISCSTOP+ CBP-540**

·suitable for **Shimano XTR M975 / M966 / M965, XT M776 / M775 / M765, SLX M665, LX M585 / T665 / T605, DEORE M596 / M595 / M535, ALFINE S501 / S500, SAINT M800 - HONE M601 / BR-M545 / R505 - TRP Dash Carbon - Juin tech R1 / X1, F1 - ZOOM hb100 / db875**

0.817.425/2 CBP-540, organic	001595
0.817.479/9 CBP-540A+, organic, with aluminium plate and aluminium PIN - 50% lighter, good heat transfer and performance	001795
0.817.455/9 CBP-540S, metal, sintered	001795
0.817.094/6 CBP-540C, sintered metal, with cooling fins - 40% less wear	001995

SHIMANO

TEKTRO

CLARKS



**DISCSTOP+ CBP-550**

·suitable for **Shimano XTR BR-M9100 / BR-M9020 / M9000 / M985 / M987 / M978 / M900, XT M8100 / M8000 / M785 / R785 / RS785, SLX M7100 / M7000 / M675 / M666, DEORE M615 / M6000 / BR-CX77 / CX75 / R517 / R515 / R317 / R315, Alfine S700 - FSA K-Force TX-9000 - Afterburner DB-TX-9150 - TEKTRO HD-7910 - Riderever Arc S / U / E, Attack S / U / E - Clarks M2**

0.817.426/0 CBP-550, organic	001595
0.817.471/6 CBP-550, organic, box with 25 pairs	001595
0.817.480/7 CBP-550A+, organic, with aluminium plate and aluminium PIN - 50% lighter, good heat transfer and performance	001795
0.817.456/7 CBP-550 S, metal, sintered	001795
0.817.095/3 CBP-550C, organic, with cooling fins - 40% less wear	001995

SHIMANO

TRP



**DISCSTOP+ CBP-560**

·suitable for **Shimano XTR M9120, XT M8020 / M8120, Saint M820 / M810, ZEE M640/M7120, Deore MT520 / MT420 - TRP Quadiem Spec / SL / Slate T4, G-Spec dh / dh-r / Trail SLC / Trail s, E-zurich 2.3 / comp, Dorado 4P HD-E730 / E725 / E720, Orion 4P / M841 / 840-2 / 830 / 826 / 825 / 815 / E-840-2 / E820 / E822 / EU820 / EU821 - Juin tech gt / gtp / gtf**

0.817.427/8 CBP-560, organic	001595
0.817.483/1 CBP-560, organic, box with 25 pairs	001595
0.817.482/3 CBP-560S, sintered	001795
0.817.096/1 CBP-560C, metal, sintered, with cooling fins - 40% less wear	001995

TEKTRO



**DISCSTOP+ CBP-600**

·suitable for **Tektro IO hydraulic / mechanic**

0.817.428/6 organic	001595
---------------------	--------

TEKTRO



**DISCSTOP+ CBP-610**

·suitable for **Tektro E-Bike Dorado HD-E710**

0.817.429/4 organic 001595

TEKTRO



**DISCSTOP+ CBP-615**

·suitable for **Tektro IOX - Lyra MD-C500 - Novela MD-M311**

0.817.430/2 organic 001595

FORMULA



**DISCSTOP+ CBP-620**

·suitable for **Formula Oro**

0.817.431/0 CBP-620, organic 001595

0.817.457/5 CBP-620 S, metal, sintered 001795

SHIMANO

TEKTRO



**DISCSTOP+ CBP-625**

·suitable for **Shimano XTR BR-M9100 / M9110, Dura Ace BR-R9170, Ultegra BR-R8070 / R7070 / 4770 / RX810 / RX400, Metrea U5000 / BR-RS805 / RS505 / RS405F / RS405R / RS305-R / RS305-F / RS10 / R310 / TT / T910 / UR300 / S7000 - Tektro R802 front / EU810 front / EU811 front - Riderever attack s / u / mcx2**

0.817.458/3 CBP-625, organic 001595

0.817.458/6 CBP-625, organic, box with 25 pairs 001595

0.817.458/4 CBP-625 S, metal, sintered 001795

0.817.458/5 CBP-625 A+, organic, with aluminium plate - 50% lighter, better heat transfer and performance 001795

FORMULA



**DISCSTOP+ CBP-630**

·suitable for **Formula Mega - The One - R1 - RX - RO - T1 - C1 - Cura** series / E

0.817.432/8 CBP-630, organic 001595

0.817.472/4 CBP-630, organic, box with 25 pairs 001595

0.817.098/7 CBP-630C, sintered metal, with cooling fins - 40% less wear 001995

FORMULA



**DISCSTOP+ CBP-640**

·suitable for **Formula Cura 4**

0.817.463/3 CBP-640, organic 001595

0.817.464/1 CBP-640S, metal, sintered 001795

PROMAX



**DISCSTOP+ CBP-645**

·suitable for **Promax DKS-320/700**

0.817.435/1 CBP-645, organic 001595

ZOOM



**DISCSTOP+ CBP-650**

·suitable for **Zoom mechanic - Clarks CMD-21**

0.817.433/6 organic 001595

0.817.473/2 organic, box with 25 pairs 001595

MAGURA



**DISCSTOP+ CBP-651**

·suitable for **Magura MT 7 HC / Pro / raceline, MT 5 eStop / fabio wimber, MT Trail SL (front), MT 1893, CT5**

0.817.460/9 set with 4 pieces 002995

PROMAX



**DISCSTOP+ CBP-660**

·suitable for **Promax DKS** -200 / 200S / 400 / 420 / 400E / 400S / 610 mechanic

0.817.434/4 organic 001595

NEW

CAMPAGNOLO



**DISCSTOP+ CBP-680**

·suitable for **Campagnolo Super Record EPS, Super Record, Record EPS, Record, Chorus, Potenza**

0.817.485/7 CBP-680, organic 001595

0.817.485/8 CBP-680 C, sintered metal, with cooling fins - 40% less wear 001995

TEKTRO



**CBP-ET**

·5mm thick, onyl suitable for Tektro E-bike brakes with 2,3mm disc brake thickness, and for CONTEC rotor CDR-ET

0.817.484/9 CBP-530 ET, organic 001895

suitable for Tektro HD-T390, HD-E395 (2-piston brake), HD-M530 (2-piston brake)

0.817.485/6 CBP-560 ET, organic 001895

suitable for Tektro HD-E740, DH-E745, HD-T37, HD-M530 (4-piston brake)

NEW

160 mm DIAMETER: 180 mm DIAMETER:



**CDR-5B**

·for 5-hole disc mount  
·stainless steel  
·disc thickness: 1,8mm  
·with 5 stainless steel mounting screws

0.307.054/8 160mm, wear limit: 1,4mm, approx. 161g 002695

0.307.054/9 180mm, wear limit: 1,4mm, approx. 195g 002895

NEW

140 mm DIAMETER: 160 mm DIAMETER:

180 mm DIAMETER: 203 mm DIAMETER:



**CDR-LW-CL**

·Center Lock  
·stainless steel, aluminium  
·optimized heat management  
·with 6 stainless steel mounting screws

0.307.036/9 160mm, wear limit: 1,4mm 004395

0.307.037/0 180mm, wear limit: 1,4mm 004795

0.307.037/1 203mm, wear limit: 1,4mm, approx. 218g 004995

0.307.037/3 220mm, wear limit: 1,4mm 005795

NEW

160 mm DIAMETER: 180 mm DIAMETER:

203 mm DIAMETER: 220 mm DIAMETER:



**CDR-LW-6B**

·for 6-hole mount  
·stainless steel, aluminium  
·optimized heat management  
·with 6 stainless steel mounting screws

0.307.036/5 160mm, wear limit: 1,4mm 003595

0.307.036/6 180mm, wear limit: 1,4mm 003695

0.307.036/7 203mm, wear limit: 1,4mm 003995

0.307.036/8 220mm, wear limit: 1,4mm, 223g 004695

160 mm DIAMETER: 180 mm DIAMETER:



**CDR-CL**

·for Center Lock mount  
·stainless steel, aluminium spider  
·optimized heat transportation

0.307.035/6 Ø 160mm, wear limit: 1,4mm, approx. 146g 005495

0.307.036/4 Ø 180mm, wear limit: 1,4mm, approx. 190g 005495





**CDR-CLE**

- for Center Lock
- stainless steel disc and spider
- disc thickness: 1,8mm
- optimized heat dissipation
- E-bike compatible

0.307.054/7 140mm, wear limit: 1,4mm, approx. 141g	002695
0.307.055/4 160mm, wear limit: 1,4mm, approx. 163g	002895
0.307.056/2 180mm, wear limit: 1,4mm, approx. 185g	003095
0.307.041/4 203mm, wear limit: 1,6mm, approx. 207g	003295



**CDR-HD 1**

- for 6-hole attachment
- stainless steel, aluminium
- optimized heat transportation
- with 6 stainless steel mounting bolts

0.307.992/8 Ø 140mm, wear limit: 1,4mm, approx. 90g	002995
0.307.993/6 Ø 160mm, wear limit: 1,4mm, approx. 110g	003095
0.307.994/4 Ø 180mm, wear limit: 1,4mm, approx. 135g	003595
0.307.995/1 Ø 203mm, wear limit: 1,6mm, approx. 195g	004995



**CDR-HD 2**

- for 6-hole attachment
- stainless steel, aluminium
- optimized heat transportation
- with 6 stainless steel mounting bolts

0.307.996/9 Ø 140mm, wear limit: 1,4mm, approx. 80g	002695
0.307.997/7 Ø 160mm, wear limit: 1,4mm, approx. 100g	002995
0.307.998/5 Ø 180mm, wear limit: 1,4mm, approx. 130g	003595
0.307.999/3 Ø 203mm, wear limit: 1,6mm, approx. 190g	004995



**CDR-ET**

- for 6-hole disc mount
- stainless steel
- with 6 stainless steel screws
- especially suitable for Tektro E-bike brakes with Ø 2,3mm e.g. HD-M750, HD-E745, HD-E740, HD-E735, HD-E730, HD-T390p

0.307.072/9 Ø 160mm, wear limit: 1,8mm	002395
0.307.073/7 Ø 180mm, wear limit: 1,8mm	002595
0.307.074/5 Ø 203mm, wear limit: 1,8mm	002795



**CDR-2**

- for 6-hole attachment
- stainless steel, lightweight and solid
- with 6 stainless steel mounting bolts

0.717.377/6 Ø 160mm, wear limit: 1,4mm, approx. 99g	002195
0.717.378/4 Ø 180mm, wear limit: 1,4mm, approx. 125g	002295
0.717.379/2 Ø 203mm, wear limit: 14mm, approx. 179g	002395

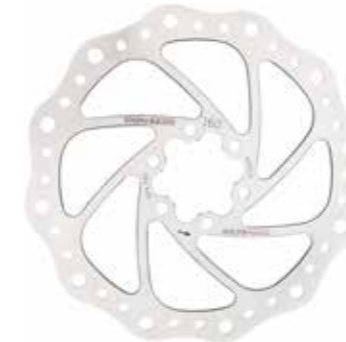

**CDR-1**

- for 6-hole attachment
- stainless steel
- with 6 stainless steel mounting bolts

0.717.666/2 Ø 140mm, wear limit: 1,4mm, approx. 119g	001795
0.717.374/3 Ø 160mm, wear limit: 1,4mm, 130g	001795
0.717.375/0 Ø 180mm, wear limit: 1,4mm, 160g	001995
0.717.376/8 Ø 203mm, wear limit: 1,6mm, approx. 190g	002195

Disc adapters / accessories **Brakes**



**LOCK-A-RING**

- locking for Center Lock rotors
- compatible with QR and 12mm and 15mm thru axles

0.307.039/8 black	000795
-------------------	--------



**CDA-CL**

- Center Lock to 6-hole mount
- allows the attachment of 6-hole brake disc to Center Lock hub
- incl. screws

0.717.312/3 black	002195
-------------------	--------





**CDA-PM-IS**

·brake caliper adapter for mounting larger rotors  
·Post Mount (PM) brake caliper to international standard fork / frame (IS)

0.717.505/2 160mm front	001195
0.717.506/0 180mm front	001195
0.717.509/4 203mm front	001495
0.717.517/7 160mm rear	001495
0.717.521/9 180mm rear	001495
0.717.511/0 203mm rear	001495



**CDA-PM**

·brake caliper adapter for mounting larger rotors  
·Post Mount (PM) brake caliper to PM fork / frame PM

0.717.512/8 from 160mm to 180mm	001495
0.717.513/6 from 160 to 203mm	001495
0.717.512/5 from 160 to 220mm	001495
0.717.512/6 from 180 to 220mm	001495
0.717.512/7 from 203 to 220mm	001495



**CDA-IS**

·brake caliper adapter for mounting larger rotors  
·international standard IS brake caliper to international standard frame / fork IS

0.717.514/4 180mm front, 160mm rear	001595
0.717.515/1 203mm front, 180mm rear	001595



**CDA-PM-FM**

·brake caliper adapter to mount larger disc brakes  
·CNC-machined

0.717.871/8 PM brake - FM fork, 140mm front	001195
0.717.872/6 PM brake - FM fork, 160mm front	001195
0.717.873/4 PM brake - FM frame, 140mm rear	001195
0.717.874/2 PM brake - FM frame, 160mm rear	001195
0.717.875/9 FM brake - FM frame, 160mm rear	001195



**SCREWR**

·for flat mount adapter  
·set with 2 pieces

0.717.880/9 M5 x 8, for FM brake - FM fork 140/160mm and FM frame 160mm	000495
0.717.881/7 M5 x 15, for FM brake - FM fork 140/160mm	000495
0.717.882/5 M5 x 19	000495
0.717.883/3 M5 x 24	000495
0.717.884/1 M5 x 29	000495
0.717.885/8 M5 x 34	000495
0.717.886/6 M5 x 39	000495
0.717.887/4 M5 x 44	000495

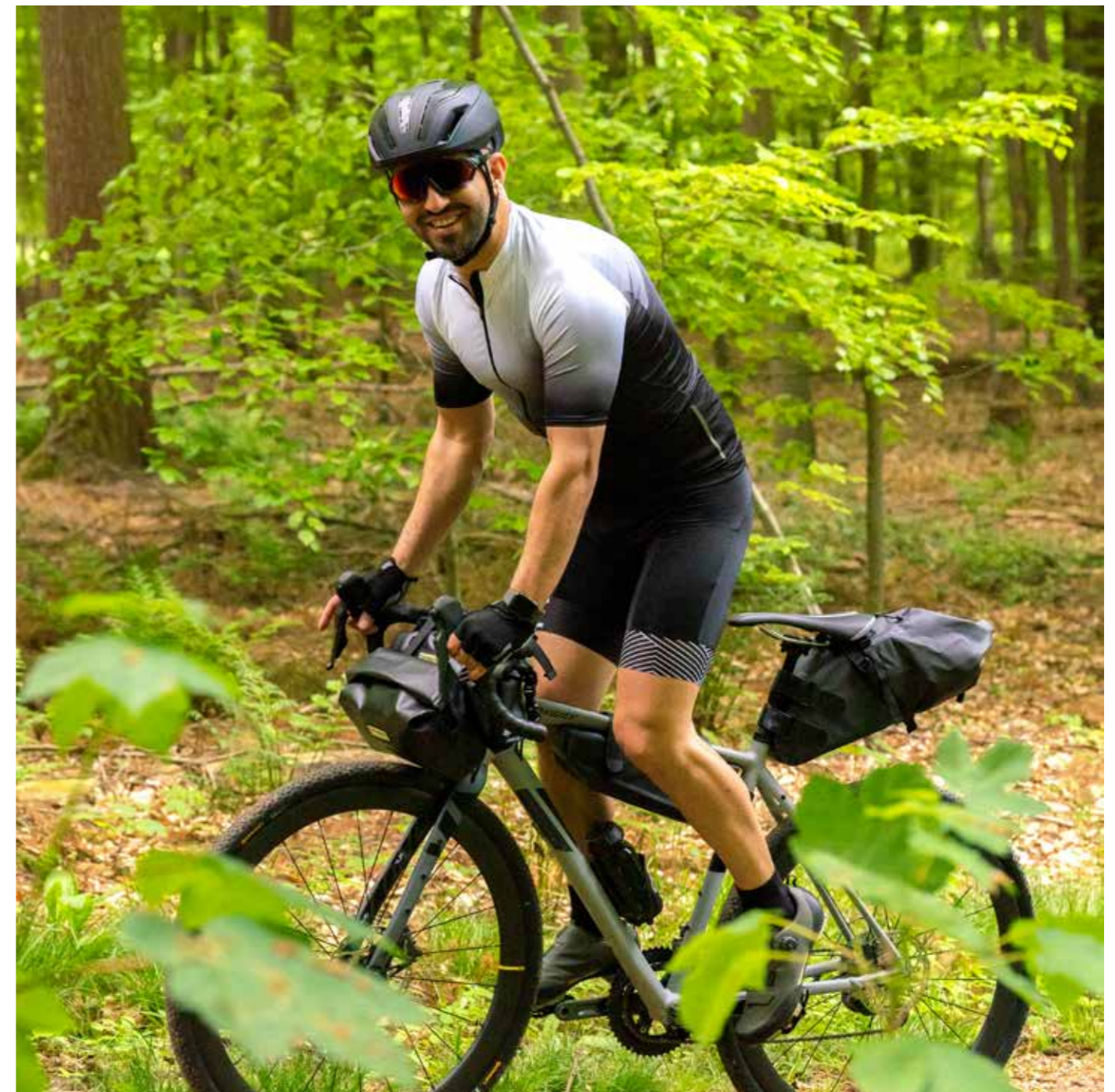

50  
PIECES



**STOP++**

- steel, PTFE
- Ø 1,5mm
- 2000mm long
- incl. one end cap

0.307.902/7 self-service package, universal, incl. 1 end sleeve	000795
0.307.914/2 workshop box with 50 pieces, with barrel end nipple	039795
0.307.915/9 workshop box with 50 pieces, with pear end nipple	039795



**STOP++**

- front and rear
- steel, PTFE coated
- Ø 1,5mm
- 1010mm / 2010mm long
- with 2000mm outer casing, 6 sealed aluminium cable covers and 2 end caps

0.307.922/5 black	002995
0.307.923/3 white	002995

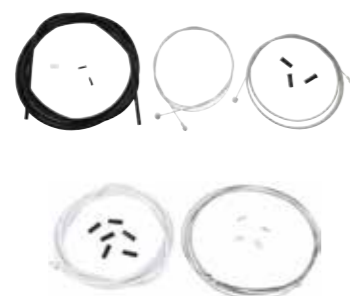

**STOP+**

- front and rear
- stainless steel
- Ø 1,5mm
- 1010mm / 2010mm long
- with 2000mm outer casing, 6 sealed cable covers and 2 end caps

0.307.905/0 black	001995
0.307.906/8 white	001995



**NEO STOP+**

- front and rear
- stainless steel
- Ø 1,5mm
- 1010mm / 2010mm long
- with 2000mm outer casing, 6 sealed cable covers and 2 end caps

0.307.907/6 coolgrey	001995
----------------------	--------

100  
PIECES



**STOP+**

- stainless steel
- Ø 1,5mm
- 2000mm long
- incl. one end cap

0.307.901/9 self-service package, universal, incl. 1 end sleeve, 1 pear nipple and 1 barrel nipple	000495
0.307.912/6 workshop box with 100 pieces, with barrel end nipple	049595
0.307.913/4 workshop box with 100 pieces, with pear end nipple	049595

40 m  
LENGTH



**STOP**

- workshop box with 40m
- Ø 5mm

0.307.916/7 black	005995
-------------------	--------



**STOP**

- steel
- Ø 1,5mm
- 2000mm long
- incl. one end cap

0.307.900/1 PreLube, galvanized	000395
---------------------------------	--------



**R/STOP**

- rear, compl.
- steel
- Ø 1,5mm
- with outer casing, 2 cable covers and 1 end cap

0.307.904/3 PreLube inner cable, galvanized, 2000mm, 1900mm outer casing	000595
--	--------



**F/STOP**

- front
- steel
- Ø 1,5mm
- with outer casing, 2 cable covers and 1 end cap

0.307.903/5 PreLube inner cable, galvanized 1000mm, 610mm outer casing	000495
--	--------



200  
PIECES



**STOP**

- O-ring
- for brake cables
- bottle with 200 pieces

0.307.917/5 black 002995

200  
PIECES



**STOP**

- stop sleeve
- for brake cable outer casing
- Ø 5mm
- bottle with 200 pieces

0.307.918/3 silver 002995

150  
PIECES



**STOP**

- cable cover
- für brake cable outer casing
- plastic
- Ø 5mm
- bottle with 150 pieces

0.307.919/1 black 002495

500  
PIECES



**STOPSHIFT**

- end sleeve
- for Ø 1mm - 1,6mm brake and derailleur cables
- bottle with 500 pieces

0.348.999/4 silver 002495



**BRAKE CABLE-GUIDING PIPE**

- flexible
- front / rear

0.317.054/5 silver 000295



**V-STOP**

- for V-brakes
- incl. rubber dust cover

0.307.920/9 front 90° 000395

0.307.921/7 rear 135° 000395

NEW



**DISC STOP HOSE**

- hydraulic brake line
- made of double braided high strength nylon fiber
- universally shortenable
- roll with 20 meters

0.717.003/2 inner Ø 2,3mm, outer Ø 5mm, suitable for Shimano BH-59 and Tektro brakes 008995

0.717.003/5 inner Ø 2,1mm, outer Ø 5mm, suitable for Shimano BH-90, Sram and Formula brakes 008995

0.717.003/3 inner Ø 2,5mm, outer Ø 5,35mm, suitable for Hayes and Tektro brakes 008995

NEW



**DISC STOP SHIMANO COMPLETE**

- set for Shimano disc brake lines
- consisting of
- line nipple (pins)
- clamping rings (olives)
- union nut or banjo
- seals
- 2000mm brake line

0.717.002/9 with banjo connector 002595

0.717.003/0 with union nut 001795

NEW



**DISC STOP EXTEND**

- set to extend disc brake lines by 500mm
- consisting of:
- cable nipples (pins)
- clamping rings (olives)
- union nuts
- connector
- brake line

0.717.002/7 for Avid / SRAM disc brake lines 001995

0.717.002/8 for Shimano disc brake lines 001795

NEW



**DISC STOP HYDRO FUEL**

- bleeding kit for disc brakes from Avid/Sram, Formula, Hayes, Hope, Magura and Shimano
- consisting of:
- 2 syringes
- 2 clamps
- 2 hoses
- various hose connectors
- M8 jaw wrench
- gloves
- 50ml bottle to fill with used oil

0.717.003/4 box 004995

NEW



**DISC STOP SELECTION**

- spare part box for Avid/SRAM, Formula, Hayes, Magura and Shimano disc brake lines
- consisting of:
- line nipples (pins)
- clamping rings (olives)
- union nuts
- seals

0.717.003/1 Content for 10 lines per manufacturer	021995
---	--------

NEW



**DISC STOP SHIMANO**

- for Shimano disc brake lines

0.717.001/1 line nipple (pin), suitable for SM-BH 90, set with 10 pieces	001295
0.717.001/3 line nipple (pin), suitable for all common Shimano brake lines, set with 10 pieces	001295
0.717.001/4 clamping ring (olive), set with 10 pieces	000595
0.717.001/5 set for 1 bike, consisting of 2x line nipples (pin) and 2x clamping rings (olive), suitable for all common Shimano brake lines	000395
0.717.001/6 set for 1 bike, consisting of 2x line nipples (pin) and 2x clamping rings (olive), suitable for all common Shimano brake lines	000395

NEW



**DISC STOP MAGURA**

- for Magura disc brake lines

0.717.001/7 line nipple (pin), set with 10 pieces	001295
0.717.001/8 clamping ring (olive), set with 10 pieces	000595
0.717.001/9 set for 1 bike, consisting of 2x line nipple (pin) and 2x clamping ring (olive)	000395

NEW



**DISC STOP AVID / SRAM**

- for Avid / SRAM disc brake lines

0.717.002/1 line nipple (pin), set with 10 pieces	002995
0.717.002/2 clamping ring (olive), set with 10 pieces	001195
0.717.002/3 set for 1 bike, consisting of 2x line nipple (pin) and 2x clamping ring (olive)	000995

NEW



**DISC STOP TEKTRO**

- for Tektro disc brake lines

0.717.002/4 line nipple (pin), set with 10 pieces	001295
0.717.002/5 clamping ring (olive), set with 10 pieces	000595
0.717.002/6 set for 1 bike, consisting of 2x line nipple (pin) and 2x clamping ring (olive)	000395







G-Link

Compatible with CONTEC G-Link grips. Components with this mark can be mounted directly on the G-Link handle in a space-saving and ergonomic way.



KIDS

Especially for children. Parts and accessories that feature design, size and color especially for the youngest cyclists.



# GRIPS



## The right feeling

Feeling is one of our seven senses that make cycling an experience. We feel the breeze in our hair, the sun on our skin and the grips in our hands. That's why the choice of grips is so important for making us feel good while cycling. Factors such as material, shape and adjustment play an important role. Not every grip fits every hand, nor every riding style. The position on the bike determines the body weight that weighs on the

contact points on the hands. At CONTEC you will find a wide variety of grips made of different materials, in different shapes and for individual riding styles. The MERGE grips series is even equipped with our G-Link interface that allows you to mount practical accessories such as a bicycle mirror or a bell directly to the grip.



MERGE TREKKING BAR P.86

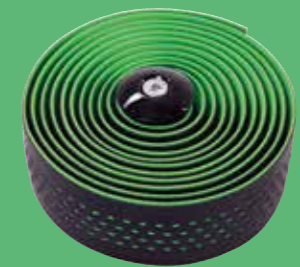

GOO D2 P.101



# Get a grip on comfort



Our MERGE grips are designed to fit you – not the other way around. They are divided into the categories city, urban, trekking and mountain, which should give you a clue in the selection. If you ride more in an upright sitting position, the MERGE City grips are particularly well suited. For a more active riding style, the MERGE Trekking grips fit great. If you are often in mountainous landscapes on the MTB, you should

look at the MERGE Mountain series. On our YouTube channel, we introduce you to the MERGE grips and the G-Link system in detail. Just scan the QR code on this page. Not so keen on rubber? No problem, our MERGE grips are now also available in cork! Not only do they look chic, but they are also made from environmentally friendly, renewable raw materials.



## MERGE TREKKING BAR

- D3-triple density
- integrated cushioning
- ergonomic shape, multiposition
- incl. Contec G-Link system

0.318.809/1 140mm	003495
0.318.810/9 96 / 140mm	003495



## MERGE TREKKING ERGO

- D3-triple density
- integrated cushioning
- ergonomic shape
- incl. Contec G-Link system

0.318.807/5 140mm	002995
0.318.808/3 96 / 140mm	002995



## MERGE CITY ERGO

- D3-triple density
- integrated cushioning
- ergonomic shape
- incl. Contec G-Link system

0.318.813/3 140 mm	002995
0.318.814/1 96 / 140mm	002995



## MERGE CITY COMFORT

- D3-triple density
- integrated cushioning
- ergonomic shape
- incl. Contec G-Link system

0.318.811/7 140mm	002795
0.318.812/5 96 / 140mm	002795



## MERGE MOUNTAIN COMFORT

- D3-triple density
- integrated cushioning
- ergonomic shape
- incl. Contec G-Link system

0.318.805/9 140mm	002795
0.318.806/7 96 / 140mm	002795



## MERGE MOUNTAIN STRAIGHT

- D3-triple density
- integrated cushioning
- 140mm
- incl. Contec G-Link system

0.318.804/2 black / grey	002495
--------------------------	--------



## MERGE URBAN

- D2-dual density
- integrated damping
- 140mm
- incl. Contec G-Link system

0.318.815/8 black / grey	002495
--------------------------	--------

NEW



## MERGE TREKKING BAR KORK

- D3-triple density
- integrated cushioning
- ergonomic form
- cork / black
- incl. CONTEC G-Link system

0.318.822/4 140mm	003495
0.318.823/2 96 / 140mm	003495

NEW

**MERGE TREKKING ERGO KORK**

- D3-triple density
- integrated cushioning
- ergonomic form
- cork / black
- incl. CONTEC G-Link system

0.318.820/8 140mm 002995

0.318.821/6 96 / 140mm 002995

NEW

**MERGE CITY ERGO KORK**

- D3 three components
- integrated cushioning
- ergonomic form
- cork / black
- incl. CONTEC G-Link system

0.318.826/5 140mm 002995

0.318.827/3 96 / 140mm 002995

NEW

**MERGE CITY COMFORT KORK**

- D3-triple density
- integrated cushioning
- ergonomic form
- cork / black
- incl. CONTEC G-Link system

0.318.824/0 140mm 002795

0.318.825/7 96 / 140mm 002795

NEW

**MERGE MOUNTAIN COMFORT KORK**

- D3-triple density
- integrated cushioning
- ergonomic form
- cork / black
- incl. CONTEC G-Link system

0.318.818/2 140mm 002795

0.318.819/0 96 / 140mm 002795

NEW

**MERGE MOUNTAIN STRAIGHT KORK**

- D3 three components
- integrated cushioning
- 140mm
- incl. CONTEC G-Link system

0.318.817/4 cork / black 002495

NEW

**MERGE URBAN KORK**

- D2 two components
- integrated cushioning
- 140mm
- incl. CONTEC G-Link system

0.318.816/6 cork / black 002495

## Good to know

### Sensitive touch silicone

Thanks to the inclusion of air bubbles, the special silicone compound provides natural cushioning in strategically important places and offers high grip in all weather conditions. The anti-allergic material is particularly skin-friendly and therefore ideal for long tours in any weather.

### Cork

Environmentally friendly and renewable resource with an optimized skin tolerance. Cork has a high breathability, great sweat absorption and reduces micro vibrations.

### D2-Dual density

The handrest area with the soft gel mixture provides comfort and shock absorption and the hard outside part for good grip on the handlebar.

### D3-Triple density

The medium gel mixture is placed in the front of the grip to ensure a firm and secure grip for the fingers. The soft mixture is in the rear area to avoid vibrations. A hard mixture in the inner grip supports the weight of the hand.

### Foam

Absorbs the shocks and reduces the vibrations during the ride.

### D2-Dual density taped

Grip core wrapped with shock absorbing dual density handlebar tape.

### Leather

It offers a high comfort and breathability thanks to high quality leather and grants natural temperature regulation.

### Kraton

Special elastomer that combines cushioning comfort, abrasion and weather resistance.

**GLINK BOSCH REMOTE**

- bracket for Bosch remote control unit
- suitable for all CONTEC grips from "MERGE" series

0.318.104/7 black

000195

**G-LINK KLEMMRING**

- for Merge grips

0.318.828/1 black

000495

**G-LINK SPACER**

- for Merge grips

0.318.829/9 black

000495

**G-LINK**

- for Merge grips

0.318.830/7 black

000295

# Well shaped

**Wings**

The wings are the wide surfaces where your palms rest on the grip. They prevent an unnatural bending of the wrists. This way fatigue, numbness and pain are avoided during longer trips.

**Bar ends**

Bar ends are the "horns" on the outer ends of the grips. They provide an additional hand position during bike riding. Changing the grip position prevents fatigue, which is particularly important for long trips over many kilometers on the saddle.

**Lockring handlebar clamp**

With a lockring, the grips always keep their position and don't move during a bikeride. All thanks to the integrated screw lock. The lockrings are easy to install and offer more comfort, safety and a high quality look.

**TOUR WING DLX**

- silicone
- clamping rings on the outside, ideal for twist grip shifters
- ergonomic shape
- 133mm

0.318.219/3 black

002995

**TOUR WING**

- D2-dual density
- clamping rings on the outside, ideal for twist grip shifters
- ergonomic shape
- black / grey

0.318.098/1 133 / 93mm long

001995

0.318.099/9 133mm long

001995

**TOUR WING ECO**

- clamping rings on the outside, ideal for twist grip shifters
- ergonomic shape
- black

0.318.228/4 138 / 98mm long

001495

0.318.229/2 138mm long

001495





**TOUR DELUXE PRO**

- D3-triple density
- ergonomic shape, multiposition
- 140mm

0.318.994/1 black / grey 002595



**TOUR DELUXE PRO KORK**

- D3-triple density
- ergonomic shape
- 140mm

0.318.942/0 cork / black 002995



**TOUR DELUXE KORK**

- D3-triple density
- ergonomic shape
- cork / black

0.318.940/4 135mm long 002495  
0.318.941/2 92 / 135mm long 002495



**ERGO KORK +**

- D3-triple density
- ergonomic shape
- 130mm

0.318.970/1 cork / black 001995



**TOUR PRO KORK**

- D2-dual density
- ergonomic shape
- cork / black

0.318.991/7 135mm long 001895  
0.318.992/5 92 / 135mm long 001895



**ERGO +**

- D3-triple density
- ergonomic shape
- 133mm

0.318.967/7 black / grey / green 001995  
0.318.968/5 black / white / red 001995



**ERGO +**

- D2-dual density
- ergonomic shape
- black / grey

0.318.904/0 130mm long 000995  
0.318.905/7 92 / 130mm long 000995



**TOUR ERGO**

- D2-dual density
- ergonomic shape
- black / grey

0.318.981/8 135mm long 000995  
0.318.982/6 92 / 135mm long 000995

**CLASSIC EXCLUSIV MELLOW**

·leather

0.318.363/9 125mm long, honey	005995
0.318.364/7 125mm long, gravy	005995
0.318.365/4 125mm long, coffee	005995
0.318.366/2 95 / 125mm long, honey	005995
0.318.367/0 95 / 125mm long, gravy	005995
0.318.368/8 95 / 125mm long, coffee	005995

**MIRAGE ERGO EXCLUSIV**·with leather covered D3-triple density-core  
·ergonomic shaped

0.318.611/1 135mm long, coffee	003495
0.318.612/9 135mm long, gravy	003495
0.318.613/7 135mm long, honey	003495
0.318.614/5 92 / 135mm long, coffee	003495
0.318.615/2 92 / 135mm long, gravy	003495
0.318.616/0 92 / 135mm long, honey	003495

**CLASSIC EXCLUSIV GEEBEE**

·leather

0.318.602/0 125mm long, coffee	003995
0.318.601/2 125mm long, gravy	003995
0.318.600/4 125mm long, honey	003995
0.318.605/3 95 / 125mm long, coffee	003995
0.318.604/6 95 / 125mm long, gravy	003995
0.318.603/8 95 / 125mm long, honey	003995

**ERGO EXCLUSIV +**·grip with leather covered D3-triple density-core  
·ergonomic shape  
·135mm

0.318.801/8 coffee	002995
0.318.803/4 gravy	002995
0.318.802/6 honey	002995

**MIRAGE EXCLUSIV**·leather  
·double handlebar clamp  
·131mm

0.318.608/7 honey	003995
0.318.609/5 gravy	003995
0.318.610/3 coffee	003995

**TOUR EXCLUSIV**·with artificial leather embraced D1-single density-core  
·ergonomic shape

0.318.935/4 135mm long, coffee	001595
0.318.936/2 92 / 135mm long, coffee	001595
0.318.926/3 135mm long, gravy	001595
0.318.927/1 92 / 135mm long, gravy	001595

**TOUR EXCLUSIV PRO**·with artificial leather embraced D2-dual density-core  
·ergonomic shape

0.318.947/9 135mm long, coffee	002595
0.318.948/7 92 / 135mm long, coffee	002595
0.318.945/3 135mm long, honey	002595
0.318.946/1 92 / 135mm long, honey	002595

**TRAVELLER**

·leather

0.318.955/2 138mm long, black	002795
0.318.954/5 92 / 138mm long, black	002795
0.318.957/8 138mm long, brown	002795



**TRAIL**

·D2-dual density  
·125mm

0.318.928/9 black	001995
0.318.995/8 white	001995



**TRAIL PRO**

·D2-dual density  
·135mm

0.318.938/8 black	001995
0.318.996/6 white	001995



**TRAIL X**

·D2-dual density  
·X-Grip lamination  
·135mm

0.318.997/4 black	001995
-------------------	--------



**ZEN**

·silicone - ultra light & super grip  
·non-slip without screw connection  
·135mm

0.318.951/1 neoblue	001995
---------------------	--------



**TRAIL D3 EVO NEO**

·D3-triple density  
·135mm

0.318.347/2 neogreen / black	001995
0.318.348/0 neoblue / black	001995
0.318.349/8 neoyellow / black	001995
0.318.352/2 neored / black	001995



**TRAIL SHOCK**

·D2-dual density  
·129mm

0.318.993/3 black	001995
-------------------	--------



**TRAIL FOAM**

·foam  
·129mm

0.318.932/1 black	001995
-------------------	--------



**TRAFFIC FOAM**

·foam  
·129mm

0.318.933/9 black	001995
-------------------	--------



**DURA KORK**

·cork

0.318.937/0 127mm long	000995
0.318.939/6 92 / 127mm long	000995



**JOLLY KID+**

- Kraton rubber
- with bulging protection and flange
- 100mm

0.318.431/0 black	000795
0.318.431/1 magenta	000795
0.318.431/2 blue	000795
0.318.431/3 green	000795
0.318.431/4 orange	000795

**JOLLY KID**

- Kraton rubber
- with impact protection and flange
- 115mm

0.318.426/4 black	000795
0.318.430/6 orange	000795

**HAPPY KID**

- Kraton rubber
- with bulging ball and flange for max. safety
- 105 mm

0.318.891/9 neored	000795
0.318.892/7 neoblue	000795
0.318.893/5 neogreen	000795
0.318.894/3 neoyellow	000795



**2**  
SETS

**BLOCK RING**

- aluminium grip ring
- set with 2 pieces
- black

0.318.831/0 suitable for CONTEC grips "Traffic Foam", Trail Shock", "Ergo Kork+", "Tour Deluxe Kork", "Tour Deluxe Pro Kork"	000695
0.318.831/1 suitable for CONTEC grips "Trail", "Trail X", "Trail Pro", "Trail Foam"	000695

**2**  
SETS

**G-RING SELECT**

- aluminium grip clamp ring
- suitable for Trail/Trail Pro/Trail X
- set with 2 pieces

0.318.255/7 rocket silver	000695
0.318.257/3 limousine black	000695
0.318.258/1 blue steel	000695
0.318.266/4 ultra violet	000695
0.318.267/2 guerilla green	000695
0.318.268/0 odd orange	000695

**2**  
SETS

**G-CAP SELECT**

- aluminium grip end clamp cap
- suitable for Trail/Trail Pro/Trail X
- set with 2 pieces

0.318.269/8 rocket silver	001095
0.318.270/6 honky white	001095
0.318.271/4 limousine black	001095
0.318.272/2 blue steel	001095
0.318.273/0 riot red	001095
0.318.274/8 heart of gold	001095
0.318.276/3 guerilla green	001095
0.318.277/1 odd orange	001095

**HANDLEBAR PLUGS**

- made of plastic, with fixed screw
- pair

0.316.927/3 black	000495
-------------------	--------

**HANDLEBAR COVER**

- foam cover for multi function handlebar
- black

0.318.005/6 4 x 400mm	000795
0.318.006/4 6 x 400mm	000995

**ISO TAPE**

- insulating tape
- 15mm wide
- 4,5m long

0.319.402/4 black	000395
-------------------	--------

**Grips Handlebar tapes****KORK 2K**

- synthetic cork bar tape
- with engraved branding
- reduces pressure and vibrations
- elastic, optimum grip
- incl. plugs and adhesive tape

0.319.919/7 white	001395
0.319.920/5 black	001395
0.319.921/3 yellow	001395
0.319.922/1 red	001395
0.319.923/9 blue	001395
0.319.924/7 green	001395

**CARBON**

- polyurethane bar tape in carbon look
- incl. plugs and adhesive tape

0.319.918/9 carbon	001495
--------------------	--------

**GOO+**

- high quality bar tape with anti-slip surface
- the PU-coating basis reduces pressure and remarkable vibrations
- incl. 2 plugs and adhesive tape

0.319.961/9 black	002795
-------------------	--------

**GOO D2**

- high quality Dual Density D2 bar tape with anti-slip surface
- PU-coating basis reduces pressure and remarkable vibrations
- incl. 2 plugs with cone clamp and adhesive tape

0.319.962/7 black / coolgrey	002995
0.319.963/5 black / neored	002995
0.319.964/3 black / neoyellow	002995
0.319.965/0 black / neoblue	002995
0.319.966/8 black / neogreen	002995

**MICRO 2K**

- high quality micro fiber bar tape
- PU-cating basis reduces pressure and remarkable vibrations
- very elastic and optimum grip
- washable
- incl. plugs and adhesive tape

0.319.929/6 black / grey	001995
--------------------------	--------

**ULTRA 2K**

- high quality micro fiber bar tape, with ultrasoft surface
- PU-coating basis reduces pressure and remarkable vibrations
- very elastic and optimum grip
- washable
- incl. plugs and adhesive tape

0.319.941/1 black / grey	001995
--------------------------	--------



**DMND 2K**

- high quality synthetic PU bar tape
- material mix with gel improves comfort, reduces vibrations and ensures good adhesion
- very elastic and optimum grip
- washable
- incl. plugs and adhesive tape

0.319.998/1 white	001595
0.319.997/3 black	001595
0.319.992/4 coolgrey	001595
0.319.996/5 neogreen	001595
0.319.995/7 neoblue	001595
0.319.994/0 neoyellow	001595
0.319.993/2 neored	001595

**CLASSIC EXCLUSIV BEETEE**

- leather
- incl. plugs

0.319.899/1 coffee	006995
0.319.898/3 gravy	006995
0.319.897/5 honey	006995

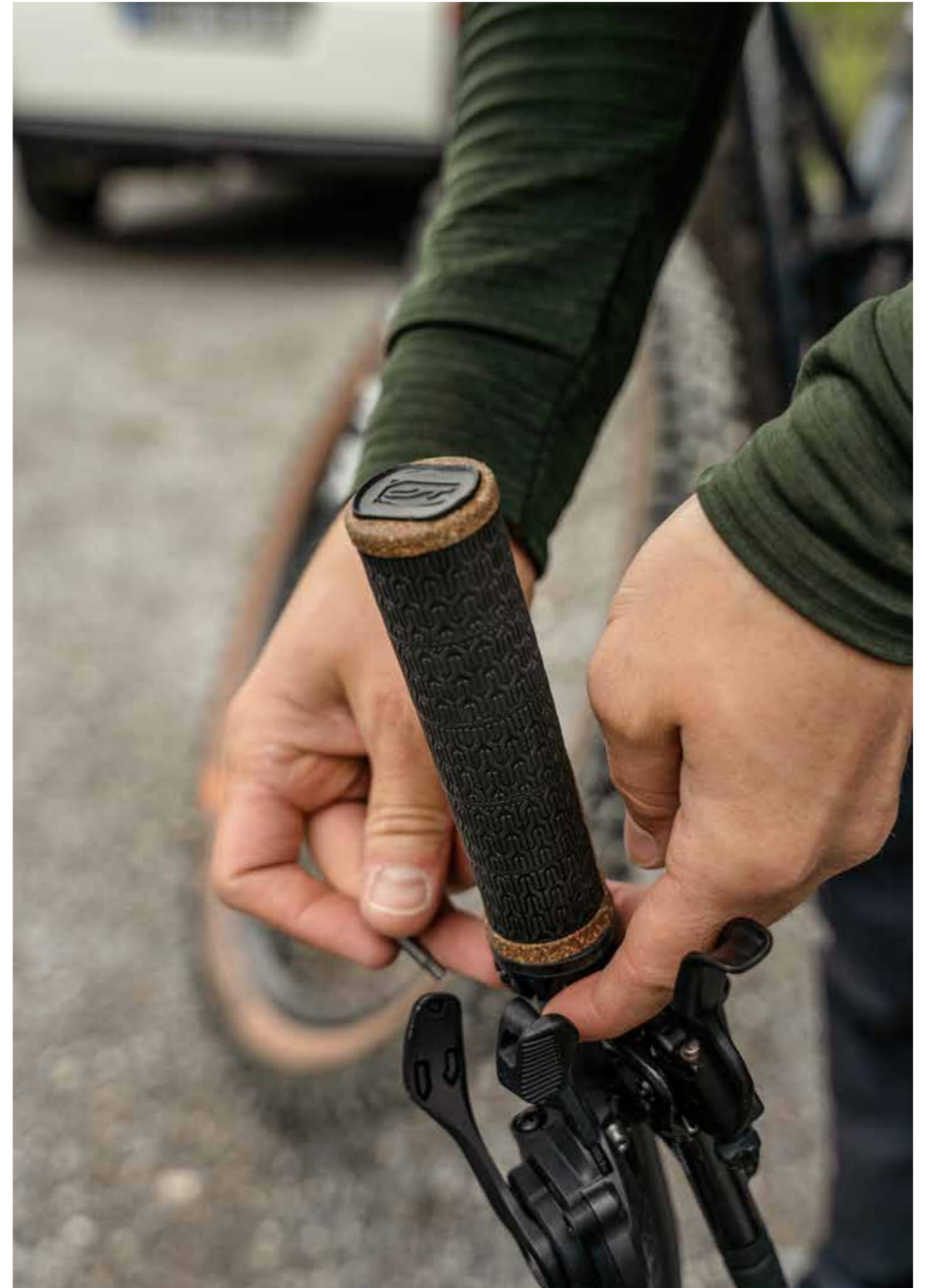





G-Link

Compatible with CON-TEC G-Link grips. Components with this mark can be mounted directly on the G-Link grip in a space-saving and ergonomic way.



## G-LINK



# Grip in integration

G-Link is an innovative system that connects ergonomic grips with practical accessories, such as mirrors or bells, on the handlebar. The connection brings the accessories closer to the hand, which ensures improved ergonomics. The clear and uncluttered look is another plus.

**Here's how it works:**

The G-Link system consists of the CONTEC MERGE grips as well as various accessories. All parts from our G-Link range have a 14-edged ring, which ensures the seam-

less connection between the grips and the accessories. Via the 14 edges you can also adjust the accessories in its position individually to the grip and the hand position on the bike. So elementary attachments, such as our Bosch remote mount with G-Link interface, moves closer to the hand.



MERGE TREKKING ERGO KORK P.111



E-VIEW EVO GL P.112

# Grip in integration

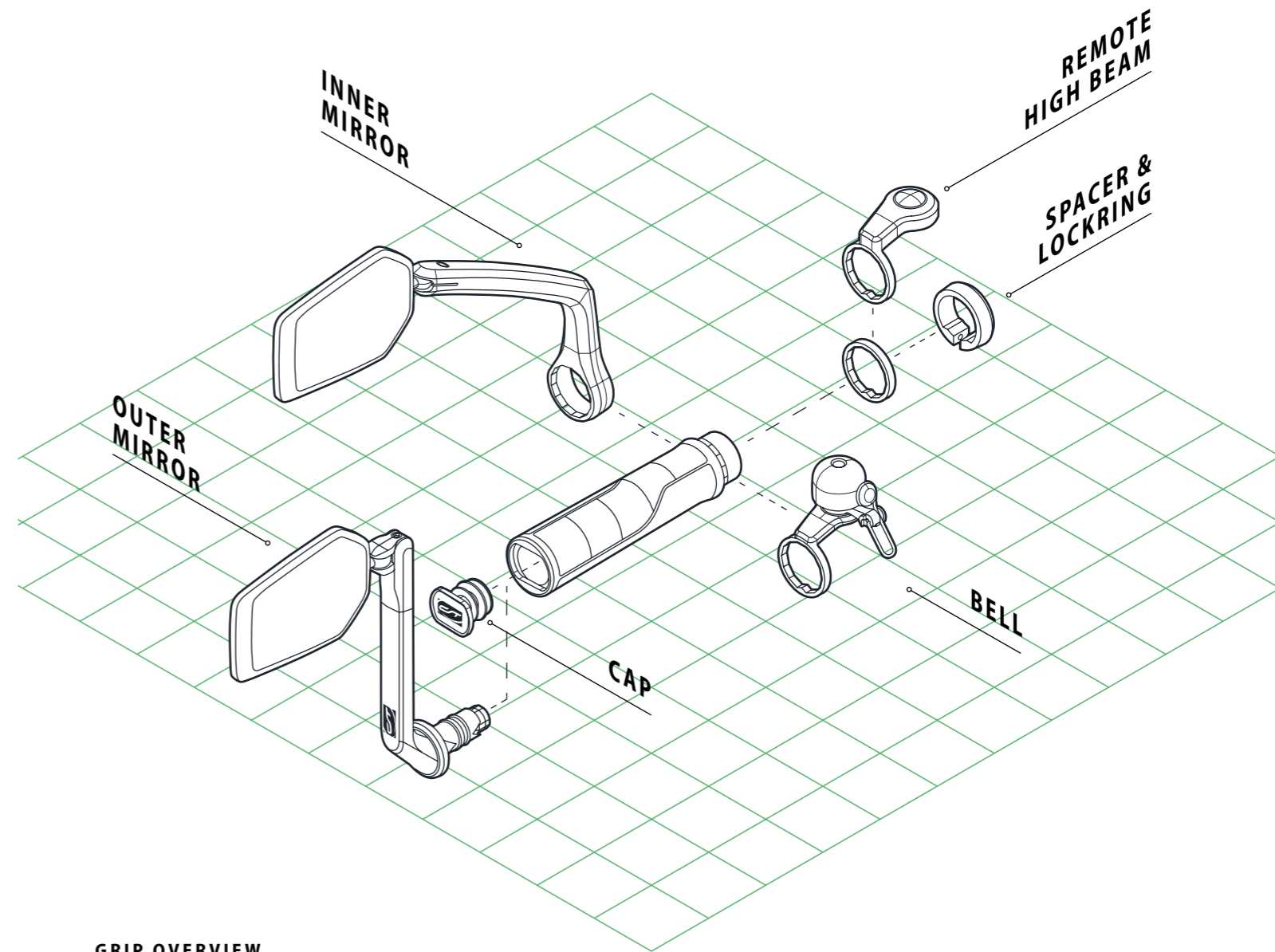

## GRIP OVERVIEW

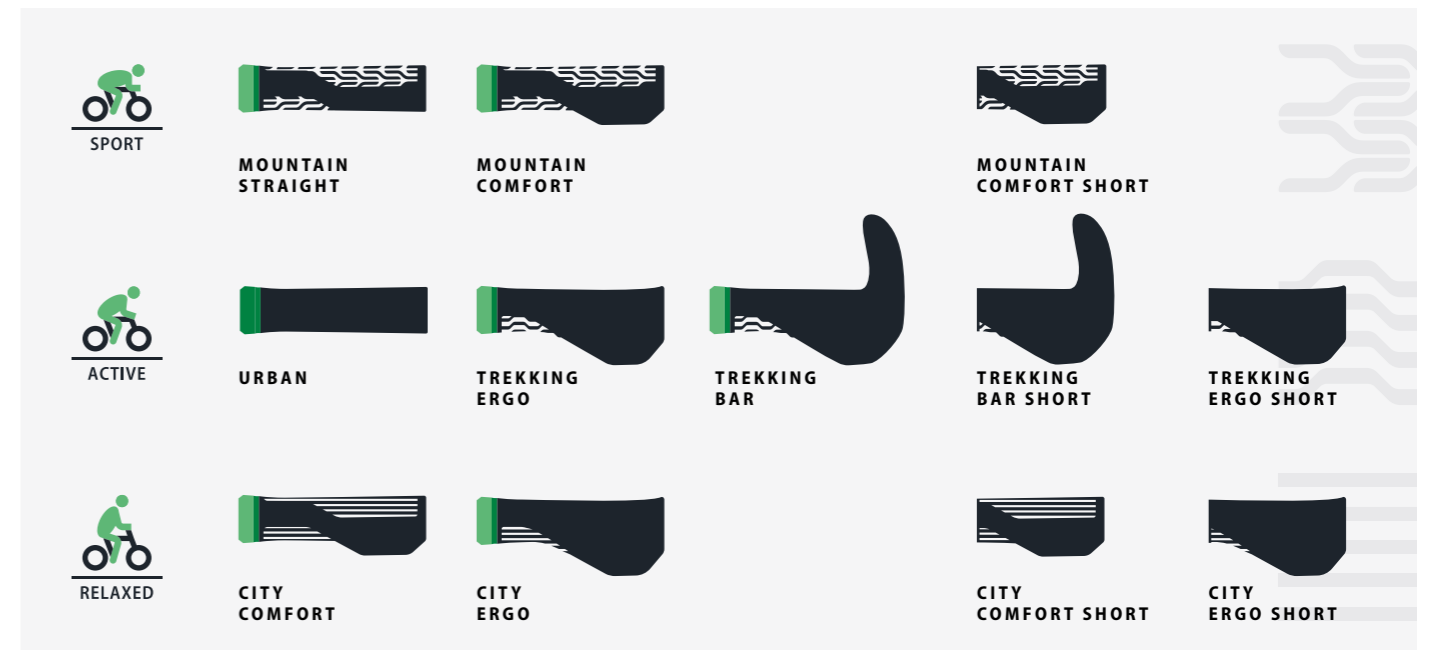

# Ergonomics with flair



## MERGE TREKKING BAR

- D3-triple density
- integrated cushioning
- ergonomic shape, multiposition
- incl. Contec G-Link system

0.318.809/1 140mm	003495
0.318.810/9 96 / 140mm	003495



## MERGE CITY COMFORT

- D3-triple density
- integrated cushioning
- ergonomic shape
- incl. Contec G-Link system

0.318.811/7 140mm	002795
0.318.812/5 96 / 140mm	002795



## MERGE CITY ERGO

- D3-triple density
- integrated cushioning
- ergonomic shape
- incl. Contec G-Link system

0.318.813/3 140mm	002995
0.318.814/1 96 / 140mm	002995



## MERGE MOUNTAIN COMFORT

- D3-triple density
- integrated cushioning
- ergonomic shape
- incl. Contec G-Link system

0.318.805/9 140mm	002795
0.318.806/7 96 / 140mm	002795



## MERGE MOUNTAIN STRAIGHT

- D3-triple density
- integrated cushioning
- 140mm
- incl. Contec G-Link system

0.318.804/2 black / grey	002495
--------------------------	--------



## MERGE TREKKING ERGO

- D3-triple density
- integrated cushioning
- ergonomic shape
- incl. Contec G-Link system

0.318.807/5 140mm	002995
0.318.808/3 96 / 140mm	002995



## MERGE URBAN

- D2-dual density
- integrated damping
- 140mm
- incl. Contec G-Link system

0.318.815/8 black / grey	002495
--------------------------	--------



# Good for you and the environment

NEW



## MERGE CITY COMFORT KORK

- D3-triple density
- integrated cushioning
- ergonomic form
- cork / black
- incl. CONTEC G-Link system

0.318.824/0 140mm	002795
0.318.825/7 96 / 140mm	002795



NEW



## MERGE CITY ERGO KORK

- D3 three components
- integrated cushioning
- ergonomic form
- cork / black
- incl. CONTEC G-Link system

0.318.826/5 140mm	002995
0.318.827/3 96 / 140mm	002995

NEW



## MERGE MOUNTAIN COMFORT KORK

- D3-triple density
- integrated cushioning
- ergonomic form
- cork / black
- incl. CONTEC G-Link system

0.318.818/2 140mm	002795
0.318.819/0 96 / 140mm	002795

NEW



## MERGE MOUNTAIN STRAIGHT KORK

- D3 three components
- integrated cushioning
- 140mm
- incl. CONTEC G-Link system

0.318.817/4 cork / black	002495
--------------------------	--------

NEW



## MERGE TREKKING BAR KORK

- D3-triple density
- integrated cushioning
- ergonomic form
- cork / black
- incl. CONTEC G-Link system

0.318.822/4 140mm	003495
0.318.823/2 96 / 140mm	003495

NEW



## MERGE TREKKING ERGO KORK

- D3-triple density
- integrated cushioning
- ergonomic form
- cork / black
- incl. CONTEC G-Link system

0.318.820/8 140mm	002995
0.318.821/6 96 / 140mm	002995

NEW



## MERGE URBAN KORK

- D2 two components
- integrated cushioning
- 140mm
- incl. CONTEC G-Link system

0.318.816/6 cork / black	002495
--------------------------	--------

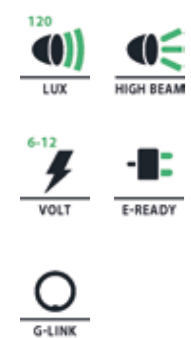
**DLUX 120 E-XTENT**

- low beam 120 lux / 350 lumen
- high beam 200 lux / 1850 lumen
- OSRAM LED
- incl. high beam button with radio control
- for connection to an e-bike battery with 6-12V
- incl. plastic universal bracket
- aluminium housing
- with removable front reflector
- incl. Contec G-Link system and standard handlebar clamp

0.710.970/5 black	019595
-------------------	--------

**E-VIEW EVO GL**

- universal adjustable
- suitable for right and left handlebar clamp with Ø 22,2mm
- safety glass lens (97 x 68mm)
- with Dazz lens (up to 75% less reflections)
- incl. Contec G-Link system and standard handlebar clamp

0.322.923/4 matt black	002995
------------------------	--------

**DIAMOND BING GL**

- brass
- Ø 45mm
- bell head 360° rotatable
- suitable for left and right
- incl. Contec G-Link system

0.320.996/2 matt black	000995
------------------------	--------

**GLINK BOSCH REMOTE**

- bracket for Bosch remote control unit
- suitable for all CONTEC grips from "MERGE" series

0.318.104/7 black	000195
-------------------	--------





VOLUME

Indicates the filling volume of the drinking bottle



## BOTTLES

# One refill please!

You should drink more! Your loved ones will not say this sentence to you in vain. Because an adult human being consists of about 50 to 65 percent water, and during exercise we lose a large amount of fluids through sweating. That's why it's so important to drink plenty of water on longer bike rides. To ensure that you don't have to worry about the contents of your bottle ending up in your backpack instead of your stomach, you can easily attach a bottle cage to your bike.

And we have plenty of new models – with new colors, new materials and clever extras!

**Space Tool:** The Space Tool bottle cage is more than just a safe container for your drink, it has a smart additional holder for a minitool with 9 functions. In addition to a Phillips and slotted screwdriver, the minitool has T15, T20 and T25 star keys and 3, 4, 5 and 6mm hex keys. This means that almost all the tools you need for quick service on the road are on board.

### Supply artist

There's nothing more refreshing than reaching for your water bottle during a quick stop on an exciting bike ride! Thanks to the ergonomic silicone mouthpieces on our Rivers M and L bottles, the water flow is particularly high. With all Rivers bottles we relied on an odorless and tasteless bottle body made of BPA-free material. So nothing stands in the way of refreshment!

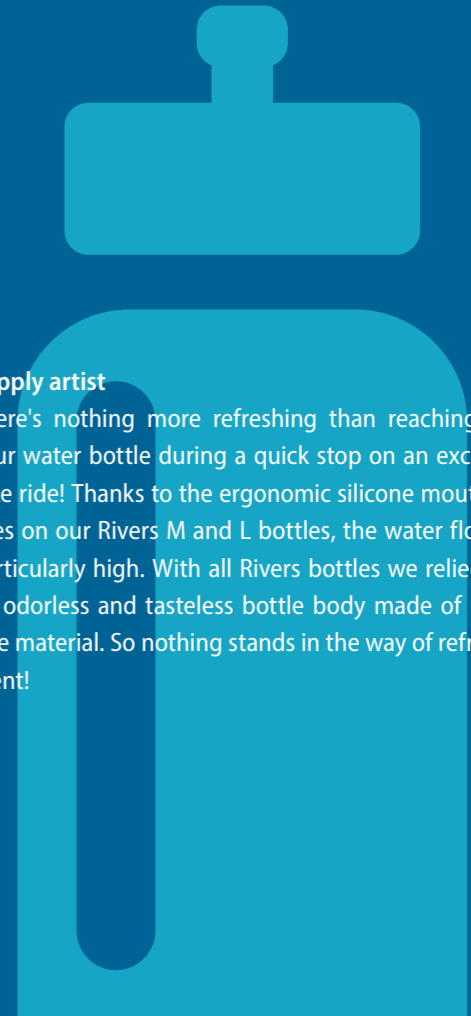

SPACE TOOL P.116



RIVERS L P.123





**COALCAGE**

- carbon-fibre reinforced nylon
- 17g

0.319.450/3 black	003495
-------------------	--------

NEW



**SPACE TOOL**

- nylon
- incl. multitool (T15, T20, T25)
- 99g

0.319.944/2 black / grey	002995
0.319.944/3 black / green	002995

NEW



**LITE CAGE**

- nylon / carbon
- 19g

0.319.944/4 black	002495
0.319.944/6 eucalyptus green	002495

NEW



**SPACE CAGE**

- nylon / carbon
- 31g

0.319.944/0 green / grey	001395
0.319.944/1 black / green	001395



**BTO**

- aluminium
- 29g

0.319.447/9 black	001395
0.319.448/7 silver	001395



**ORIGINAL**

- plastic
- 35g

0.319.449/5 black	000995
-------------------	--------



**NEO CAGE**

- plastic
- 29g

0.319.442/0 black / coolgrey	001395
0.319.443/8 black / neoblue	001395
0.319.444/6 black / neogreen	001395
0.319.445/3 black / neored	001395
0.319.446/1 black / neoyellow	001395



**LEFT2RIDE**

- plastic
- 44g
- lateral removal
- for right- and left-handres

0.319.983/3 black	001395
-------------------	--------

NEW



**POUND CAGE**

- 6061 aluminium
- incl. edge protection
- 60g

0.319.080/0 matt black	000995
0.319.080/1 matt silver	000995
0.319.080/2 matt white	000995
0.319.080/3 matt red	000995
0.319.080/4 matt green	000995
0.319.080/5 matt blue	000995
0.319.080/6 matt orange	000995



**POUND CAGE**

- aluminium 6061
- 60g

0.319.130/1 black	000995
-------------------	--------



**POUND CAGE SELECT**

- aluminium 6061
- 60g

0.319.131/9 black / limousine black	000995
0.319.132/7 black / riot red	000995
0.319.133/5 black / blue steel	000995
0.319.134/3 black / odd orange	000995
0.319.135/0 black / heart of gold	000995
0.319.136/8 black / rocket silver	000995
0.319.137/6 black / honky white	000995
0.319.138/4 black / ultra violet	000995
0.319.139/2 black / guerilla green	000995



**POUND CAGE NEO**

- aluminium 6061
- 60g

0.319.156/6 black / neoyellow	000995
0.319.157/4 black / neogreen	000995
0.319.158/2 black / neored	000995
0.319.159/0 black / neoblue	000995
0.319.160/8 black / coolgrey	000995



**POUND CAGE PET**

- aluminium 6061
- for PET bottles and cans 0,33l - 0,6l
- 99g

0.319.027/9 black	001295
-------------------	--------



**AERO FLEX**

- very light aluminium 5052 bottle cage
- Elastomer insert, guarantees a secure hold of the bottle
- 24g

0.319.000/6 black	001495
-------------------	--------



**AERO FLEX**

- very light aluminium 5052 cage
- elastomer insert for better fixation of the water bottle
- 24g

0.319.925/4 black	001495
-------------------	--------



**AERO LITE**

- very flexible plastic cage
- no scuff marks on aluminium bottles
- 28g

0.319.927/0 black	000995
-------------------	--------



**AERO XS**

- aluminium 6061 cage
- 45g

0.319.934/6 black	000995
0.319.935/3 carbon-look	001395



**2NINE**

- plastic
- no scuff marks on aluminium bottles
- 29g

0.319.942/9 black	000995
0.319.943/7 white	000995



**SLACKER CAGE**

- aluminium 6061
- optimized for small frames
- adaptable for right or left hand
- construction without welded seams
- 41g

0.319.940/3 black	001195
-------------------	--------



**CLASSIC**

- aluminium 6061
- 45g

0.319.902/3 silver	000895
0.319.903/1 black	000895



**RETRO CLASSIC**

- aluminium
- classic shape
- with real and high quality leather applications
- 100g

0.319.906/4 polished silver	001595
-----------------------------	--------



**BAR CLASSIC**

- aluminium 6061
- for handlebar till Ø 22,2mm
- 110g

0.319.909/8 black	000995
-------------------	--------



**BC**

- aluminium adapter for the handlebar
- allows mounting of the bottle cage on the handlebar Ø 22,2 - 25,4mm
- incl. screws and spacer

0.319.908/0 black	001195
-------------------	--------



# Refreshment until the last sip

Proper hydration on the bike is important if you are active for a long period of time. This applies to everyday cyclists as well as sporty bikers. To keep you hydrated on the way, there's nothing easier than a quick grab for a water bottle. This is particularly enjoyable, for example, due to the ergonomic silicone bottle bites with high water flow with our Rivers M and L bottles. For all Rivers bottles we rely on an odorless and tasteless bottle bodies made of BPA-free materials. This underlines the high-quality drinking experience and helps a better refreshment on the bike.



## RIVERS ECO L

- 800ml
- polypropylene odorless and tasteless
- easy to squeeze
- ergonomic shaped bottle bite
- BPA-free
- dishwasher-safe

0.319.888/4 black / coolgrey

000795



## RIVERS ECO M

- 650ml
- polypropylene odorless and tasteless
- easy to squeeze
- ergonomic shaped bottle bite
- BPA-free
- dishwasher-safe

0.319.887/6 black / coolgrey

000695



## RIVERS L

- 800ml
- plastic
- 100% leakproof over double closure system
- ergonomic bottle bite
- BPA-free
- dishwasher-safe

0.319.822/3 white / stripes

001295

0.319.823/1 black / coolgrey

001295

0.319.824/9 black / neoblu

001295

0.319.825/6 black / neogreen

001295



## RIVERS M

- 650ml
- plastic
- 100% leakproof over double closure system
- ergonomic bottle bite
- BPA-free
- dishwasher-safe

0.319.818/1 white / stripes

001095

0.319.819/9 black / coolgrey

001095

0.319.820/7 black / neoblu

001095

0.319.821/5 black / neogreen

001095





G-Link

Compatible with CONTEC G-Link grips. Components with this icon can be mounted directly on the G-Link grip in a space-saving and ergonomic way



KIDS

Especially for children. Parts and accessories that feature design, size and color especially for the youngest cyclists



## BELLS

# Soundful accessories



Make way! Now you come! Bicycle bells are designed to alert other road users to your presence. Whether you "only" choose a loud sound or add a colorful design is up to you. At CONTEC you will find a wide range of bells with different looks, sounds and mounting options. Our new Space-A-Ding is specially designed for mounting on the steerer tube and is therefore perfect for racing or gravel bikes. If you would like to

individualize its bike in matching colors, you should take a look at our renewed Diamond Bings: The clappers bring a little color accent to your handlebar, which fits perfectly with other CONTEC accessories. The matte colors can also be found in our MTB parts series Kyandi or in our Pound Cage water bottle cages.



DIAMOND BING GL P.127



DIAMOND BING P.126

# You hear it ringing?

**NEW**

## DIAMOND BING

- brass
- universal handlebar clamp
- clapper rotatable by 360°
- Ø 26mm

0.320.917/0 black	000995
0.320.917/1 black / silver	000995
0.320.917/2 black / red	000995
0.320.917/3 black / green	000995
0.320.917/4 black / blue	000995
0.320.917/5 black / orange	000995



**NEW**



**NEW**



## DIAMOND BING

- brass
- suitable for handlebar Ø 22,2mm
- clapper rotatable by 360°
- Ø 26mm

0.320.916/0 matt black	000995
0.320.916/1 black / silver	000995
0.320.916/3 black / red	000995
0.320.916/4 black / green	000995
0.320.916/5 black / blue	000995
0.320.916/6 black / orange	000995

## MINI BING

- brass
- universal handlebar clamp
- clapper rotatable by 360°
- Ø 23mm

0.320.919/0 black / grey	000695
0.320.919/1 black / red	000695
0.320.919/2 black / green	000695
0.320.919/3 black / blue	000695



## DIAMOND BING GL

- brass
- Ø 45mm
- bell head 360° rotatable
- suitable for left and right
- incl. Contec G-Link system

0.320.996/2 matt black	000995
------------------------	--------

**NEW**



## BING

- aluminium
- suitable for handlebar Ø 22,2mm
- Ø 37mm

0.320.918/0 matt black	000495
0.320.918/1 matt silver	000495
0.320.918/2 matt white	000495
0.320.918/3 matt red	000495
0.320.918/4 matt green	000495
0.320.918/5 matt blue	000495
0.320.918/6 matt orange	000495
0.320.918/7 display with 20 pieces, 5x black, 5x silver, 2x white, 2x red, 2x green, 2x blue, 2x orange	007995



## BING

- aluminium
- suitable for handlebar Ø 22,2mm
- Ø 37mm

0.320.901/2 rocket silver	000495
0.320.903/8 limousine black	000495
0.320.904/6 blue steel	000495
0.320.905/3 riot red	000495
0.320.906/1 heart of gold	000495
0.320.907/9 ultra violet	000495
0.320.908/7 guerilla green	000495
0.320.909/5 odd orange	000495







**FUN PAIRED WITH SAFETY**

Our CONTEC children's bicycle bells inspire the youngest cyclists with their monster look or the design of our children's helmets. At the same time, they protect the offspring with their penetrating, bright sound. The children's bells are easy to operate, so that the little ones can reliably and loudly draw attention to themselves in traffic.



**BELLE**

- brass
- suitable for handlebar Ø 22,2mm
- Ø 34mm

0.320.442/7 blue	001295
0.320.443/5 pink	001295
0.320.444/3 mint	001295

**BEAST**

- aluminium
- suitable for handlebar Ø 22,2mm
- Ø 45mm

0.320.439/3 blue	000795
0.320.440/1 pink	000795
0.320.441/9 orange	000795
0.320.442/0 display with 20 pieces, 7x blue, 7x pink, 6x orange	013995

**KID-A-RING**

- aluminium
- suitable for handlebar Ø 22,2mm
- Ø 55mm

0.320.932/7 circus bear	000795
0.320.933/5 circus fox	000795
0.320.934/3 safety cat	000795
0.320.935/0 galaxy	000795
0.320.936/8 display with 10 pieces, 2x circus bear / 2x circus fox / 3x safety cat / 3x galaxy	007950

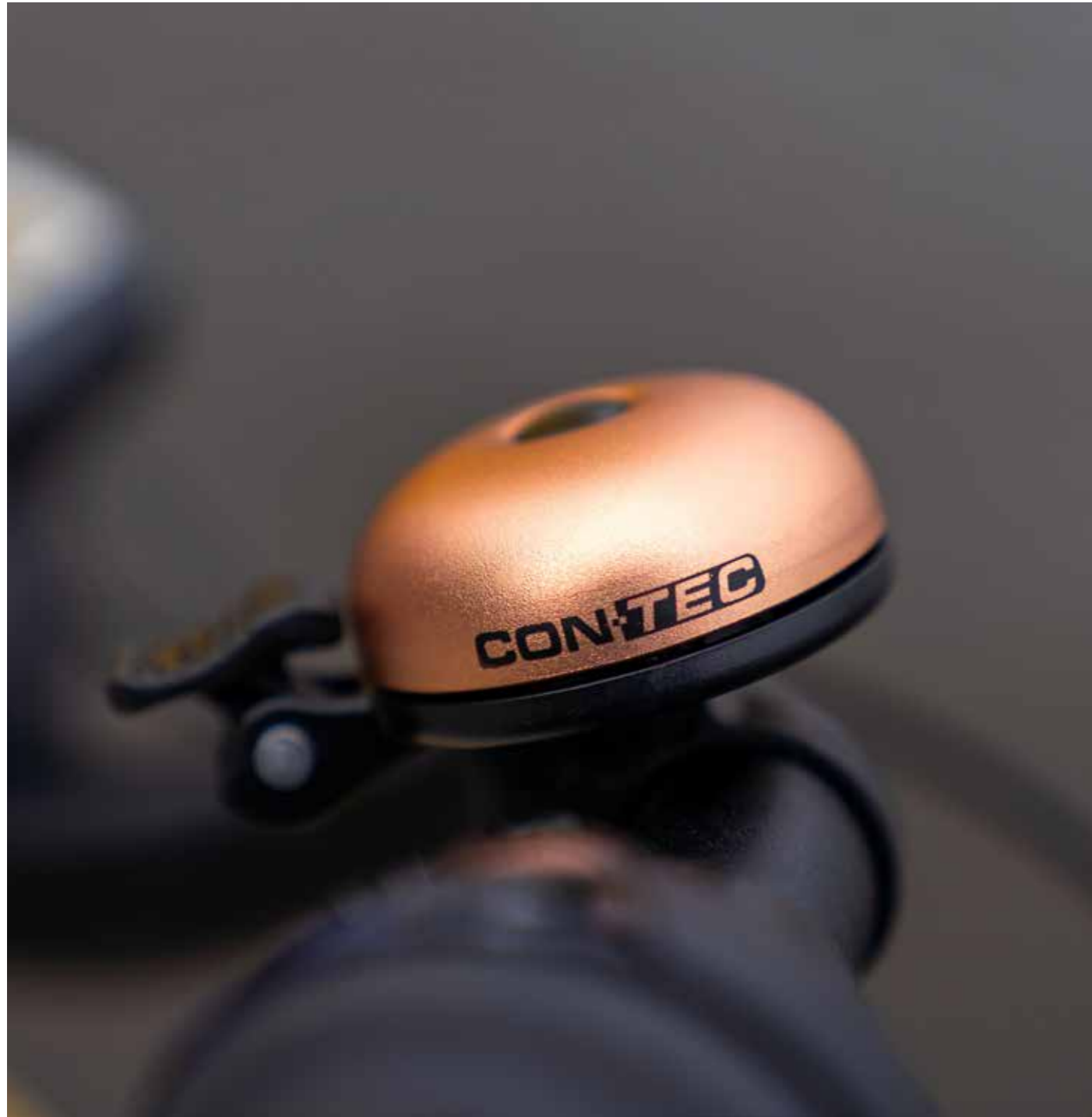

**TARTE-A-BING**

- aluminium
- suitable for handlebar Ø 22,2mm
- Ø 45mm

0.320.435/1 sandblasted black	000595
0.320.436/9 grey, sandblasted	000595
0.320.438/5 copper, sandblasted	000595
0.320.438/6 display with 20 pieces, 10x black, 5x grey, 5x copper	009995



**CUP-A-DING**

- aluminium
- clapper 360° rotatable
- Ø 34mm

0.320.422/9 silver, suitable for handlebar clamp Ø 22,2mm	000595
0.320.423/7 black, suitable for handlebar clamp Ø 22,2mm	000595
0.320.424/5 silver, with universal bracket	000595
0.320.425/2 black, with universal bracket	000595



**MOVE-E-DING**

- aluminium
- suitable for handlebar Ø 22,2mm
- Ø 32mm

0.320.977/2 black, with universal handlebar clamp	000695
0.320.979/8 black, with standard clamp	000695



**BIG DONG**

- steel
- suitable for handlebar Ø 22,2mm
- Ø 88mm

0.320.953/3 black	001195
0.320.954/1 silver	001195



**LITTLE DING**

- steel
- suitable for handlebar Ø 22,2mm
- Ø 66mm

0.320.950/9 black	000995
0.320.951/7 silver	000995



**PUSH-A-DING**

- steel
- suitable for handlebar clamp Ø 22,2mm
- Ø 50mm

0.320.420/3 silver	000595
0.320.421/1 black	000595

NEW



**SPACE-A-DING**

- brass
- for mounting as a spacer on the steerer tube
- for 1 1/8", 10mm installation height
- Ø 30mm

0.320.901/1 black	001195
-------------------	--------



**RING-E-DING**

- aluminium
- light plastic base
- suitable for handlebar Ø 22,2mm
- Ø 42mm
- e.g. pedelecs / e-bikes with limited space

0.320.956/6 black	000595
-------------------	--------



**CLASSIC DING DONG**

- brass
- suitable for handlebar Ø 22,2mm

0.320.964/0 classic Little Ding, Ø 66mm	002495
0.320.965/7 classic Big Dong, Ø 84mm	002495



**CLASSIC DING**

- suitable for handlebar Ø 22,2mm
- Ø 55mm

0.320.958/2 brass	001195
-------------------	--------



**CLASSIC DING**

- suitable for handlebar Ø 22,2mm
- Ø 47mm

0.320.966/5 brass	000995
-------------------	--------



**CLASSIC DIAMOND BING**

- suitable for handlebar Ø 22,2mm
- clapper rotatable by 360°
- Ø 26mm

0.320.976/4 brass	000995
-------------------	--------





**FUNCTION**

Number of functions that the bike computer can.



# SMART ACCESSORIES

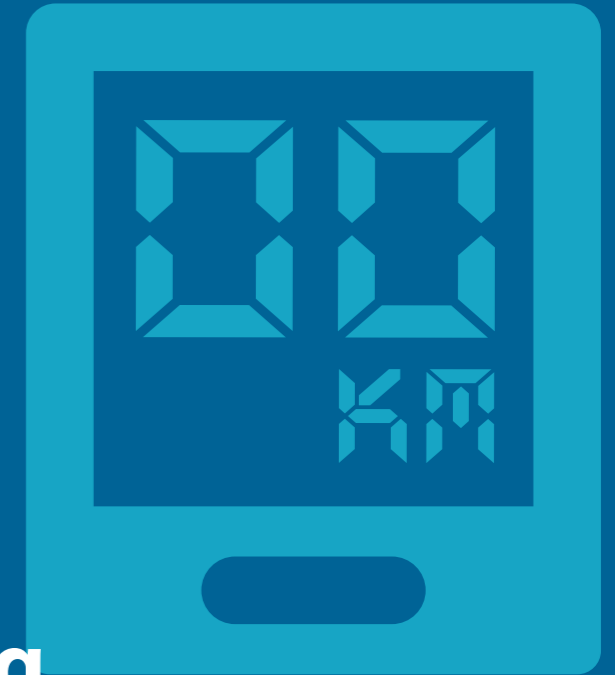

## Smart cycling

With the smart accessories from CONTEC your bike gets a great update in terms of orientation and theft protection. Many people use a navigation app on their smartphone to stay on the right track on longer bike tours. To ensure that you can fully concentrate

on cycling and always have your handlebar firmly in hand, you can mount your phone on your bike with one of our smartphone brackets! This way, you always have the option of running a navigation app on the side and don't have to constantly stop to take it out.



**CLUE RAIL P.136**



**CLUE FRAME P.136**

# Security from a distance

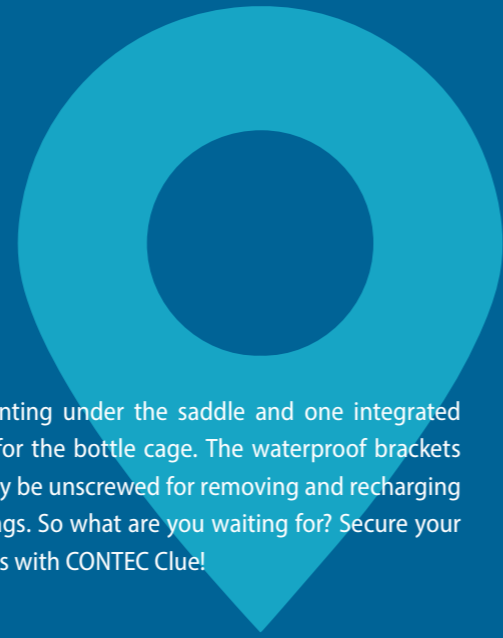

With our new AirTag brackets you always keep an eye on your bike, no matter where you are. Thanks to their clever design, the small GPS trackers can be hidden on the bike so that they won't be instantly removed the thieves. CONTEC Clue is available in two versions: one

for mounting under the saddle and one integrated version for the bottle cage. The waterproof brackets can easily be unscrewed for removing and recharging the AirTags. So what are you waiting for? Secure your valuables with CONTEC Clue!

NEW



## CLUE RAIL

- secure bracket for an Apple AirTag
- discreet attachment to the saddle brace
- firm closure protects the AirTag from splashing water and damage

0.321.955/1 black 001495

NEW



## CLUE FRAME

- secure bracket for an Apple AirTag
- discreet attachment to the bottle cage attachment
- firm closure protects the AirTag from splashing water and damage

0.321.955/0 black 001295



## ADD.ALL

- silicone universal bracket
- assembly via bottle cage eyelets or toolfree via O-rings e.g. on handlebar, frame, seat post, backpack
- for all objects with up to Ø 3 inch / 7,62cm e.g. smartphone, flashlight, water bottle, jacket

0.321.949/0 black 001995



## SPYDER

- silicone smartphone bracket
- universal suitable for all common smartphones
- toolfree assembly

0.321.950/8 black 001495



## GPS MOUNT

- bike computer bracket made of aluminium
- for handlebar Ø 31,8mm incl. spacer
- also compatible with Garmin and Mio 100 series
- 1/4 rotation - twist lock
- 20g

0.321.901/1 black 002495



## CBC-464

- wired

0.321.928/4 coolgrey / black 002195  
 0.321.929/2 neored/black 002195  
 0.321.930/0 neoblue/black 002195  
 0.321.931/8 neogreen/black 002195  
 0.321.932/6 neoyellow/black 002195





REFLECTION

Specifies by what percentage reflections and stray light are reduced, for better visibility in the rearview mirror.



E-READY

Approval for S-pedelecs / e-bikes up to 45 km/h with ECE test mark.



G-Link

Compatible with CONTEC G-Link grips. Components with this mark can be mounted directly on the G-Link handle in a space-saving and ergonomic way.



# MIRRORS



## Don't loose your focus

The CONTEC E-View bicycle mirrors allow yourself to be comfortable and safe on your bike without moving your gaze too far from the path. And with the E-View Evo models, your bike even gets a tidy look! The E-View Evo rearview mirrors are part of our G-Link system that cleverly connects handlebar accessories with grips. Thus, the mirrors can be attached both outside and inside the grip. Our Evo models are made with a Dazz lens made of special safety glass that reduces

distracting reflections by 75%. On our YouTube channel, we present the rearview mirrors in their various forms and explain how to easily mount them on the handlebar.



E-VIEW EVO GL P.140



E-VIEW EVO P.140



# Your plus for bicycle, e-bike and S-pedelec

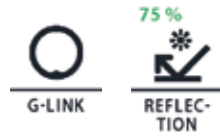

## E-VIEW EVO GL

- universal adjustable
- suitable for right and left handlebar clamp with Ø 22,2mm
- safety glass lens (97 x 68mm)
- with Dazz lens (up to 75% less reflections)
- incl. Contec G-Link system and standard handlebar clamp

0.322.923/4 matt black 002995

# Avoid looking over your shoulder



## E-VIEW DELUXE

- with Dazz lens (up to 75% less reflection)
- due to the joint at the clamp and the offset to the rear also compatible with e-bike displays (e.g. Bosch Intuvia)
- wide-angle mirror with anti-glare function
- frame made of nylon with glass fibre content
- for handlebar Ø 22,2mm

0.322.917/6 right 002995

0.322.917/6 links 002995



## E-VIEW EVO

- universal adjustable
- suitable for right and left handlebar inner clamp
- for 16mm handlebar inner clamp
- safety lens (97 x 68mm)
- with Dazz lens (up to 75% less reflection)

0.322.924/2 E-View Evo S 001995

short mirror arm (85mm)

0.322.925/9 E-View Evo M 002495

medium long mirror arm (118mm)

0.322.926/7 E-View Evo L 002995

long mirror arm (158mm)

## E-VIEW SPEED

- approved for the E-bikes up to 45 km/h
- with Dazz lens (up to 75% less reflection)
- safety glass lens
- wide-angle mirror with anti-glare function
- frame made of nylon with glass fibre content
- for handlebar Ø 22,2mm

0.322.921/8 right 003995

0.322.922/6 left 003995



## E-VIEW

- with glare lens (up to 50% less reflection)
- 360° adjustable mirror head
- safety glass lens
- nylon frame with glass fibre part
- for handlebar Ø 22,2mm

0.322.912/7 right 002295

0.322.913/5 left 002295



## E-VIEW XS

- adjustable mirror
- safety glass lens
- lens Ø 65mm
- nylon frame with glass fibre part
- for handlebar Ø 16mm
- for right or left

0.322.915/0 with dazz lens (up to 75% less reflection) 001995



## HEADSETS

### How To S.H.I.S.

The headset is the name for the bearings that ensure smooth steering on your bike. It helps to be more precise and lets the head tube turn to the left and right. There is a bearing at the top and bottom of the head tube. There used to be head and threaded headsets for bikes. With increasing diversity of the bikes and their areas of application, the differences in the headset also increased. Therefore, a standardized system for the designation of headset was created: S.H.I.S. – standardized headset identification system. With this standard, it is easier to find the right headset for your bike. The letters indicate the bearing shells. The numbers indicate the inner and outer diameter.

#### EC – external cup

In an EC headset, the bearing shells and the bearings are outside the frame, on the head tube. The thinner part of the bearing shell is pressed into the frame, the larger part of the bearing shell then provides the seat for the bearings. Example: CONTEC AHS-50

#### ZS – zero stack (semi-integrated)

A ZS headset has significantly flatter bearing shells than an EC headset. When installed, only a few millimeters of the bearing shell can be seen. The bearing is pressed into the frame with the bearing shell. Now only a thin ring, which rests on the head tube, can be seen. Example: CONTEC SHS-40

#### IS – integrated

In IS headsets, the bearings are inserted directly into the steerer tube. Because a bearing shell is no longer necessary and the bearing sits directly in the frame, these headsets are also called integrated. Example: CONTEC IHS-20

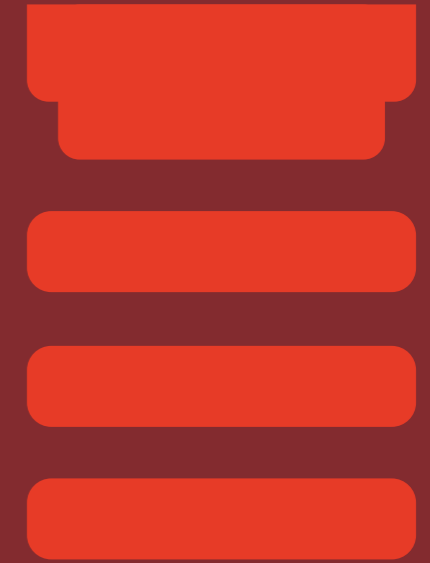



**HS-10**

- 1", steel
- sealed cartridge-ball bearings
- screwed
- crown race Ø 26,4mm

0.323.900/1 black	001395
0.323.901/9 silver	001395



**HS-20**

- 1", aluminium
- sealed cartridge-ball bearings
- screwed

0.323.902/7 black, crown race Ø 26,4mm	002795
0.323.903/5 silver, crown race Ø 26,4mm	002795
0.323.904/3 black, crown race Ø 27mm	002795
0.323.905/0 silver, crown race Ø 27mm	002795



**HS-30**

- 1 1/8", steel
- sealed cartridge-ball bearings
- screwed
- crown race Ø 30,0mm

0.323.906/8 black	001395
0.323.907/6 silver	001395



**HS-40**

- 1 1/8", aluminium
- sealed cartridge-ball bearings
- screwed, semi-integrated
- crown race Ø 30,0mm

0.323.908/4 black	002195
0.323.909/2 silver	002195



**AHS-20**

- 1 1/8", steel
- ball bearings
- crown race Ø 30,0mm
- S.H.I.S.: EC 40/28,6 EC 40/30

0.323.921/7 black	001495
0.323.922/5 silver	001495



**AHS-30**

- 1 1/8" steel
- sealed cartridge-ball bearings
- crown race Ø 30,0mm
- S.H.I.S.: EC 38/28,6 EC 38/30

0.323.923/3 black	002195
0.323.924/1 silver	002195



**AHS-40**

- 1 1/8", aluminium
- sealed industrial bearings
- crown race Ø 30,0mm
- S.H.I.S.: EC 39/28,6 EC 39/31

0.323.925/8 black	003795
-------------------	--------



**AHS-50**

- 1 1/8", aluminium
- sealed industrial bearings
- crown race Ø 30,0mm
- S.H.I.S.: EC 41/28,6 EC 41/30

0.323.926/6 black	003795
-------------------	--------



**AHS-70**

- 1,5", aluminium
- industrial sealed bearings
- with spacers & components for reducing to 1 1/8"
- incl. spacer set 1,5"
- crown race Ø 39,8mm
- S.H.I.S.: EC 52/28,6 EC 52/40

0.323.931/6 black	007995
-------------------	--------



**SHS-10**

- 1 1/8", aluminium
- ball bearings
- semi-integrated
- crown race Ø 30,0mm
- S.H.I.S.: ZS 40/28,6 ZS 40/30

0.323.940/7 black

002195

**SHS-20**

- 1 1/8", aluminium
- sealed industrial bearings
- semi-integrated
- crown race Ø 30,0mm
- S.H.I.S.: ZS 41/28,6 ZS 41/30

0.323.941/5 black

003695

**SHS-30**

- 1,5" + 1 1/8", aluminium
- sealed industrial bearings
- semi-integrated / tapered steering tube / 1 1/8" steering tube
- S.H.I.S.: ZS 41/28,6 ZS 52/40

0.323.942/3 for 1 1/8"-1,5" (tapered) forks, crown race Ø 39,8mm 004195

0.323.943/1 for 1 1/8" forks (reducer), crown race Ø 30mm 004195

**SHS-40**

- 1 1/8" aluminium
- sealed industrial bearings
- semi-integrated
- crown race Ø 30mm
- S.H.I.S.: ZS 44/28,6 ZS 44/30

0.323.032/3 black

002995

**SHS-50**

- 1 1/8" aluminium
- sealed industrial bearings
- semi-integrated
- crown race Ø 39,8mm
- S.H.I.S.: ZS 44/28,6 ZS 56/40

0.323.033/1 also suitable for Conway WME Aluminium 27,5 (Z1), 29" (Z2), WME MT (Z3) from 2015-2019 and eWME from 2017-2020 (Z4 and Z5) 002995

**SHS-60**

- 1 1/8" aluminium
- sealed industrial bearings
- semi-integrated
- crown race Ø 39,8mm
- S.H.I.S.: ZS 44/28,6 ZS 55/40

0.323.034/9 black

002295

**IHS-10**

- 1 1/8", aluminium
- sealed industrial bearings
- fully integrated
- black
- S.H.I.S.: IS 41/28,6 IS 41/41

0.323.960/5 head tube-inner Ø 41,0mm (Cane Creek Standard) 003495

0.323.961/3 head tube-inner Ø 41,8mm (Campagnolo Standard) 003495

**IHS-20**

- 1 1/8" aluminium
- sealed industrial bearings
- fully-integrated
- fork cone Ø 39,8mm
- S.H.I.S.: IS 42/28,6 IS 52/40

0.323.035/6 also suitable for Conway WME Carbon 27,5 (Z1), 29" (Z2) from 2015-2019 002995

**ISHS-80**

- 1 1/8" - 1,5" (tapered), aluminium
- industrial sealed bearings
- full-/semi-integrated
- crown race Ø 39,8mm
- S.H.I.S.: IS 42/28,6 ZS 56/40

0.323.006/7 black

004495



**TONCER**

·set with 24 aluminium spacers  
·4x 2mm, 6x 5mm, 6x 10mm, 4x 15mm, 4x 20mm

0.323.971/2 1", black	002295
0.323.972/0 1 1/8", silver	002295
0.323.973/8 1 1/8", black	002295



**CARBON**

·set with 5 carbon spacers  
·3x 5mm, 1x 10mm, 1x 15mm  
·100% full carbon in UD-finish

0.323.985/2 1 1/8"	001495
--------------------	--------



**SELECT**

·set with 5 aluminium spacers  
·3x 5mm, 1x 10mm, 1x 15mm  
·1 1/8"

0.323.912/6 honky white	000895
0.323.914/2 blue steel	000695
0.323.915/9 riot red	000695
0.323.916/7 heart of gold	000695
0.323.917/5 ultra violet	000695
0.323.918/3 guerilla green	000695
0.323.919/1 odd orange	000695



**SPALER**

·set with 5 aluminium spacers  
·3x 5mm, 1x 10mm, 1x 15mm

0.323.975/3 1", silver	000495
0.323.976/1 1", black	000495
0.323.977/9 1 1/8", silver	000495
0.323.978/7 1 1/8", black	000495
0.323.984/5 1 1/8", matt black	000795
0.323.983/7 1,5", black	000895
0.323.986/0 1,5", matt black	000795



**COAL.CONE**

·ahead clamp  
·1 1/8"  
·for carbon forks

0.323.965/4 "COAL.CONE", aluminium cap	001395
0.323.966/2 "COAL.CONE LITE", carbon cap	002495



**BLOCK CAP**

·with aluminium cap and screw  
·black

0.323.990/3 black	000495
-------------------	--------



**CRAWLER**

·ahead clamp  
·with aluminium cap and screw

0.323.990/2 1", silver	000495
0.323.991/0 1", black	000495
0.323.992/8 1 1/8", silver	000495
0.323.993/6 1 1/8", black	000495
0.323.998/5 1,5", black	000895



**SELECT**

·ahead clamp  
·with aluminium cap and screw

0.323.929/0 rocket silver	000595
0.323.932/4 honky white	000595
0.323.936/5 heart of gold	000595



forward stretched posture, like on MTB or road bike - back at an angle of 45° and less



slightly bent forward posture, e.g. on a trekking bike - back is at a 60° angle to the road



upright posture on city bike or Holland bike - back is at a 90° angle to the road

# ERGONOMY

## Rider and bike as a unit

A well adjusted machine runs best, largely maintenance and wear free. It's the same with your body and your bike. In case of insufficient adaptation to your body, in the long run discomfort, numbness and pain will set in. To ride healthy and pain-free, we offer you all the components to customize your bike or e-bike perfectly for you. Thereby you can easily understand the correct setting for you and your riding style yourself by three steps and narrow down the large selection of our components for

yourself. Your CONTEC specialist will be happy to advise you on how to further improve your ergonomic seating position on the bike.

01 You and your bike - depending on your riding style - relaxed, active or sportive - your body weight is distributed differently on the different contact points saddle and grips, which results in special requirements on their condition.

### 01



**MOUNTAINBIKES / RACE**  
angle approx. 45°



**TREKKINGBIKES**  
angle approx. 60°



**CITYBIKES**  
angle approx. 90°

### 02

#### FIT & ANATOMY

Depending on how upright you sit on the bike, the saddle must support more of your body weight. For an upright riding position (relaxed) you need a saddle with a large seat area, for optimal weight distribution over a larger area as possible.

With a more forward bent seating position (active or sporty), less weight weighs on the saddle and the contact area between the saddle and your buttocks becomes smaller and the saddle narrower and longer for an optimal pedal. It is important that the saddle supports your ischial tuberosities optimally to prevent pressure loads on the soft tissues, which can otherwise be caused by saddles that are too wide or too narrow.

As a general rule, women often need wider saddles than men due to an often wider pelvis. By measuring the distance between the sit bones, you can be on the safe side when choosing the right saddle.

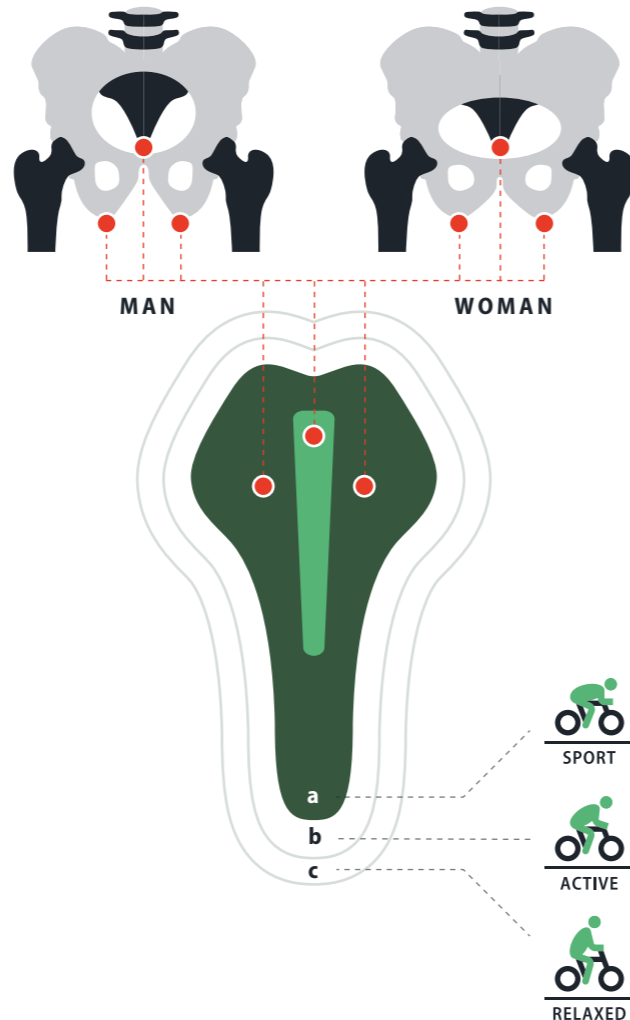

### 03

#### GRIP & BACKSWEEP

The hands support a large part of the upper body weight on the handlebars. Nerve pathways can be irritated. To make matters worse, many cyclists bend their wrists too much or mount grips incorrectly, which leads to unnatural strain and, in the long run, takes the joy out of cycling.

For handlebars with little to medium cranking to the rear (backswEEP), wing grips provide ergonomic support because they prevent the wrists, the nerves and blood vessels running in them from buckling due to a larger contact surface. It depends on the correct mounting to optimally promote the angle of the wrist.

For an upright riding position, handlebars cranked backwards with a large backswEEP are suitable to support the natural posture.



**POINT LOADS**



**LARGE CONTACT SURFACE**

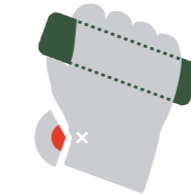

**WRONG**



**CORRECT**



**WRONG MOUNT**



**CORRECT MOUNT**

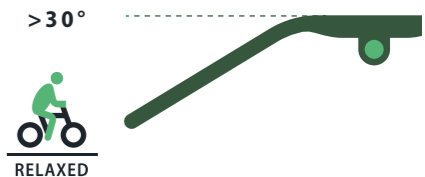
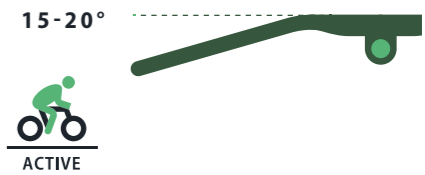
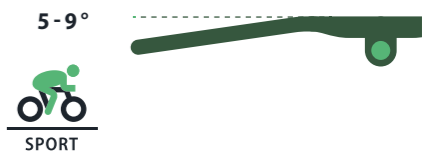





**FEMALE**  
Especially suitable for the female.



**MALE**  
Especially suitable for the male anatomy.



**UNISEX**  
Suitable for every anatomy.



**WATER PROOF**  
Waterproof for the ideal protection even in bad weather.



**KIDS**  
Especially for children. Parts and accessories that feature design, size and color especially for the youngest cyclists.



## SADDLES

# Make yourself comfortable

Comfort is defined differently by every cyclist, but for everyone it basically starts with the saddle. Because if you want to make your bike more comfortable, the first thing you'll most likely do is look for a new saddle. Our range holds a wide selection of bicycle saddles suitable for different areas of use as city, trekking, sport, e-bike, e-touring and e-MTB. Thanks to their different materials and comfort technologies, they adapt in detail to the needs of different types of cyclists.

### Comfort technologies

Full Cut describes saddles with an opening in the middle, which relieves the nerves and vessels in the dam area. O-Zone refers to saddles that only have a lowering in the middle. This provides both relief and continued blood flow in various sitting positions. Saddles with the 3-Zone technology have particularly dense padding at the three most sensitive contact

points (buttock bones and pubic bone), which provides stability and compliance to promote blood circulation.

### Cushion material:

The flexible Gel+ adapts to body temperature and prevents unpleasant pressure points. Saddles with the innovative 3-zone technology contain a cold foam Matrix with different densities to provide the cyclist with optimal support. Leather is one of the traditional saddle materials and shows its advantages especially in long-term use. The leather continuously adapts to the individual body anatomy. With our leather saddles, the hardness of the surface can also be individually adjusted with the help of a tensioning screw.



**ELLIPTIC + P.154**



**CLASSIC EXCLUSIV SPORT P.169**

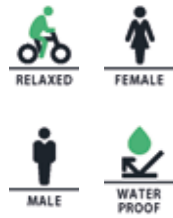

**ELLIPTIC +**

- City Zone
- Prima + gel padding
- vacuum sealed - 100% waterproof
- CV Comfort Vent+ Full Cut
- HD Bumper side protection
- ICS compatible
- black / silver

0.726.605/9 ladies, (LxW) 255 x 226mm	004995
0.726.606/7 gents, (LxW) 269 x 199mm	004995

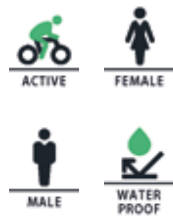
**ELLIPTIC +**

- Trekking Zone
- Prima + gel padding
- vacuum sealed - 100% waterproof
- CV Comfort Vent+ Full Cut
- HD Bumper side protection
- ICS compatible
- black / silver

0.726.607/5 ladies, (LxW): 266 x 200mm	004995
0.726.608/3 gents, (LxW): 280 x 181mm	004995

**ELLIPTIC +**

- Sport Zone
- Prima + gel padding
- vacuum sealed - 100% waterproof
- CV Comfort Vent+ Full Cut
- HD Bumper side protection
- ICS compatible
- black / silver

0.726.609/1 unisex	004995
--------------------	--------

**SCIENTIFIC**

- e-comfort / touring
- high density PU foam
- vacuum sealed - 100% waterproof
- patented LateralFlex design
- O-Zone
- E-grip recess
- steel rails

0.726.560/6 size M, black / blue	003995
0.726.561/4 size L, black / red	003995
0.726.562/2 size XL, black / blue	003995
0.726.563/0 size XXL, black / red	003995

**AEROBIC**

- E-Touring / Trekking
- AirMatrix foam
- LightFoamCore cushion core
- Touring Zone
- E-grip recess
- steel rails

0.726.558/0 unisex, size M, black / blue	004995
0.726.559/8 unisex, size L, black / red	004995

**AEROBIC**

- E-sport
- AirMatrix foam
- LightFoamCore cushion core
- Sport Zone
- E-grip recess
- steel rails
- black / grey

0.726.557/2 unisex, size S	004995
----------------------------	--------

**Very comfortable, 100% waterproof**

The advantage for comfort: The „Elliptic+“ saddle is comfortable, healthy and guarantees carefree riding. Its secret lies in the triple comfort; special foam (FM Foam Matrix), excellent gel padding and a buttock-friendly design create a comfortable riding experience. You will feel better because it supports in the right places.

# Elliptic+

The symbols on the side of each saddle already give information: In the Anatomic 2 series you will find a diverse selection of saddles for different riding styles. However, all Anatomic 2 saddles have one thing in common: high quality material! The padding made of high density PU foam is extremely durable and thus effectively absorbs shocks and vibrations that can occur when riding over bumps. The City saddles are also equipped

with an elastomer suspension. This additional suspension is particularly important to prevent back pain. With an upright seating position, the body weight is distributed mainly on the buttocks contact points.

# Anatomic 2



## ANATOMIC 2 - CITY ZONE CUT

- high density PU-foam cushioning + gel pads
- vacuum sealed - 100% waterproof
- D2-Double Density
- O-Zone full cut
- steel rails
- elastomer suspension

0.326.950/3 gents, black, (LxW): 278 x 168mm	003995
0.326.902/4 gents, dark brown, (LxW): 278 x 168mm	003995
0.326.951/1 ladies, black, (LxW): 260 x 210mm	003995
0.326.904/0 ladies, dark brown, (LxW): 260 x 210mm	003995



## ANATOMIC 2 - CITY

- high density PU-foam cushioning + gel pads
- vacuum sealed - 100% waterproof
- D2-Double Density
- O-Zone
- steel rails
- elastomer suspension

0.326.952/9 gents, black, (LxW): 272 x 213mm	003995
0.326.931/3 gents, dark brown, (LxW): 272 x 213mm	003995
0.326.953/7 ladies, black, (LxW): 253 x 207mm	003995
0.326.935/4 ladies, dark brown, (LxW): 253 x 207mm	003995



## ANATOMIC 2 - CITY LIGHT

- high density PU-foam cushioning + gel pads
- vacuum sealed- 100% waterproof
- D2-Double Density
- O-Zone
- steel rails
- elastomer suspension

0.326.958/6 gents, black, (LxW): 278 x 168mm	003495
0.326.968/5 gents, dark brown, (LxW): 278 x 168mm	003495
0.326.959/4 ladies, black, (LxW): 262 x 189mm	003495
0.326.996/6 ladies, dark brown, (LxW): 262 x 189mm	003495



**ANATOMIC 2 - TREKKING ZONE CUT**

- high density PU-foam cushioning + gel pads
- vacuum sealed - 100% waterproof
- D2-Double Density
- O-Zone full cut
- steel rails

0.326.954/5 gents, black, (LxW): 267 x 168mm 003495

0.326.955/2 ladies, black, (LxW): 246 x 169mm 003495

**ANATOMIC 2 - TREKKING**

- high density PU-foam cushioning + gel pads
- vacuum sealed - 100% waterproof
- D2-Double Density
- O-Zone
- steel rails

0.326.956/0 gents, black, (LxW): 268 x 167mm 003495

0.326.957/8 ladies, black, (LxW): 246 x 178mm 003495

0.326.966/9 ladies, dark brown, (LxW): 246 x 178mm 003495

**ANATOMIC 2 - TS**

- high density PU-foam cushioning + gel pads
- vacuum sealed - 100% waterproof
- D2-Double Density
- O-Zone
- steel rails
- (LxW) 277 x 150mm

0.326.962/8 black 003495

0.326.998/2 dark brown 003495

**ANATOMIC 2 - TSX ZONE CUT**

- high density PU-foam padding + gel pads
- vacuum sealed- 100% waterproof
- D2-Double Density
- O-Zone full cut
- steel rails
- (LxW) 252 x 140mm
- black

0.326.963/6 unisex 003495

**ANATOMIC 2 - TSZ BOW**

- high density PU-foam padding + gel pads
- vacuum sealed - 100% waterproof
- D2-Double Density
- O-Zone
- steel rails
- (LxW) 279 x 163mm
- black

0.326.965/1 unisex 003495

**ANATOMIC 2 - TSZ FLAT**

- high density PU-foam padding + gel pads
- vacuum sealed - 100% waterproof
- D2-Double Density
- O-Zone
- steel rails
- (LxW) 287 x 144mm
- black

0.326.964/4 unisex 003495

**ANATOMIC 2 - SPORT**

- high density PU-foam cushioning + gel pads
- vacuum sealed - 100% waterproof
- D2-Double Density
- O-Zone
- steel rails
- (LxW) 275 x 148mm
- black

0.326.960/2 unisex 003495

**ANATOMIC 2 - SPORT ZONE CUT**

- high density PU-foam cushioning + gel pads
- vacuum sealed - 100% waterproof
- D2-Double Density
- O-Zone full cut
- steel rails
- (LxW) 264 x 133mm
- black

0.326.961/0 unisex 003495

**VOLARE CITY XXL**

- 3Zone comfortPlus cold foam cushioning
- CrMo rails
- elastomer suspension
- (LxW) 260 x 220mm
- black

0.726.623/2 unisex 003995

**VOLARE CITY EL**

- 3Zone comfortPlus cold foam cushioning
- CrMo rails
- elastomer suspension
- (LxW) 245 x 205mm
- black

0.726.622/4 unisex 003495

**VOLARE CITY CRUISER**

- 3Zone comfortPlus cold foam upholstery
- CrMo rails
- tension and compression spring
- (LxW) 260 x 220mm
- black

0.726.758/6 unisex 003795

**VOLARE GT XL**

- 3Zone comfortPlus cold foam cushioning
- GT design: 30% more cushioning in buttocks area
- CrMo rails
- (LxW) 260 x 210mm
- black

0.726.621/6 unisex 003795

**VOLARE GT**

- 3Zone comfortPlus cold foam cushioning
- GT design: 30% more cushion in buttocks area
- CrMo rails
- black

0.726.619/0 gents, (LxW): 275 x 175mm, 408g 003495

0.726.620/8 ladies, (LxW): 255 x 185mm, 398g 003495

**VOLARE TREKKING XL**

- 3Zone comfortPlus cold foam cushioning
- CrMo rails
- (LxW) 255 x 200mm
- black

0.726.618/2 unisex 003495

**VOLARE TREKKING**

- 3Zone comfortPlus cold foam cushioning
- CrMo rails
- black

0.726.616/6 gents, (LxW): 272 x 170mm, 360g 003495

0.726.617/4 ladies, (LxW): 255 x 170mm, 340g 003495

**VOLARE HYBRID**

- 3Zone comfortPlus cold foam cushioning
- CrMo rails
- (LxW) 275 x 145mm
- black

0.726.624/0 unisex 003495

**VOLARE JUNIOR**

- 3Zone comfortPlus cold foam cushioning
- CrMo rails
- (LxW) 240 x 145mm
- black

0.726.625/7 unisex 002295



**ANATOMIC SUMO +**

- patented Foam Matrix design with + gel padding provide royal comfort with minimum pressure load
- vacuum sealed - 100% waterproof
- Look-in + gel window
- cool saddle surface reduces the heat by solar radiation
- steel rails
- with elastomers
- (LxW) 260 x 242mm
- black

0.326.994/1 unisex 003995



**ANATOMIC JUMBO +**

- patented Foam Matrix design with + gel padding provide royal comfort with minimum pressure load
- vacuum sealed - 100% waterproof
- Look-in + gel window
- cool saddle surface reduces the heat by solar radiation
- steel rails
- with elastomers
- (LxW) 260 x 227mm
- black

0.326.993/3 unisex 003995



**ANATOMIC +**

- city
- patented Foam Matrix design with + gel padding provide royal comfort with minimum pressure load
- vacuum sealed - 100% waterproof
- Look-in + gel window
- cool saddle surface reduces the heat by solar radiation
- steel rails
- (LxW) 250 x 220mm
- black

0.326.992/5 unisex 003795



**ANATOMIC +**

- trekking
- patented Foam Matrix design with + gel padding provide royal comfort with minimum pressure load
- vacuum sealed - 100% waterproof
- Look-in + gel window
- cool saddle surface reduces the heat by solar radiation
- steel rails
- black

0.326.983/4 gents, (LxW): 270 x 162mm 003795

0.326.984/2 ladies, (LxW): 250 x 185mm 003795



**ERGONOMIC**

- Matrix PU-foam padding
- comfortable Flextex cover
- Zone Cut - full cut middle section
- steel rails
- black

0.726.501/0 ladies, dimensions (LxW): 256 x 228mm 002195

0.726.500/2 gents, dimensions (LxW): 268 x 199mm 002195



**ERGONOMIC**

- Matrix PU-foam padding
- comfortable Flextex cover
- Zone - lowered middle section
- steel rails
- black

0.726.503/6 ladies, (LxW): 256 x 228mm 002195

0.726.502/8 gents, (LxW): 268 x 199mm 002195



**ERGONOMIC**

- Matrix PU-foam padding
- comfortable Flextex cover
- Zone Cut - full cut middle section
- steel rails
- black

0.726.505/1 ladies, (LxW): 263 x 198mm 002195

0.726.504/4 gents, (LxW): 283 x 179mm 002195



**ERGONOMIC**

- Matrix PU-foam padding
- comfortable Flextex cover
- Zone - lowered middle section
- steel rails
- black

0.726.507/7 ladies, (LxW): 263 x 198mm 002195

0.726.506/9 gents, (LxW): 283 x 179mm 002195





**ERGONOMIC**

- Matrix PU-foam padding
- comfortable Flextex cover
- Zone Cut - full cut middle section
- steel rails
- black

0.726.509/3 ladies, (LxW): 268 x 171mm	002195
0.726.508/5 gents, (LxW): 274 x 162mm	002195



**ERGONOMIC**

- Matrix PU-foam padding
- comfortable Flextex cover
- Zone - lowered middle section
- steel rails
- black

0.726.511/9 ladies, (LxW): 268 x 171mm	002195
0.726.510/1 gents, (LxW): 274 x 162mm	002195



**NEO PACE Z**

- high density PU cushion matrix
- O-Zone
- nylon fibre injection frame
- ArcTech suspension system
- CrMo rails
- (LxW) 280 x 140mm
- unisex

0.726.523/4 black / coolgrey	004995
------------------------------	--------



**NEO PACE ZX**

- high density PU cushion matrix
- O-Zone full cut
- nylon fibre injection frame
- ArcTech suspension system
- CrMo rails
- (LxW) 280 x 139mm
- unisex

0.726.528/3 black / coolgrey	004995
------------------------------	--------



**NEO SPORT Z DYNAMIC**

- high density PU-foam cushioning
- O-Zone
- ArcTech suspension system
- steel rails
- (LxW) 279 x 133mm
- unisex

0.726.905/3 black / coolgrey, self-service package	002995
0.726.906/1 black / neored, self-service package	002995
0.726.907/9 black / neogreen, self-service package	002995
0.726.908/7 black / neoblue, self-service package	002995
0.726.909/5 black / neoyellow, self-service package	002995

With a sporty design that exudes that certain something, you will definitely find what you are looking for in our Neo Sport saddle collection.

The different saddle shapes offer for every rider the right thing. If you are a cyclist who has a high saddle cant and an almost horizontal back position on the bike, the narrow cut models DYNAMIC and DYNAMIC ZX are just right for you. If, on

the other hand, your riding position is more upright and has only a slight saddle cant, you need a larger seat surface, which the ACTIVE saddle offers. If your handlebar is positioned at the same height or even higher than your saddle, the FIT saddle offers you pleasant support for long-lasting riding fun.

All Neo Sport saddle have our ergonomic O-Zone.

# Neo Sport

**NEO SPORT Z ACTIVE**

- high density PU-foam cushioning
- O-Zone
- ArcTech suspension system
- steel rails
- (LxW) 270 x 144mm
- unisex

0.726.910/3 black / coolgrey	002995
0.726.911/1 black / neored	002995
0.726.912/9 black / neogreen	002995
0.726.913/7 black / neoblue	002995
0.726.914/5 black / neoyellow	002995

**NEO SPORT Z FIT**

- high density PU-foam cushioning
- O-Zone
- ArcTech suspension system
- steel rails
- (LxW) 270 x 152mm
- unisex

0.726.915/2 black / coolgrey	002995
0.726.916/0 black / neored	002995
0.726.917/8 black / neogreen	002995
0.726.918/6 black / neoblue	002995
0.726.919/4 black / neoyellow	002995

**NEO SPORT ZX DYNAMIC REFLEX**

- high density PU-foam cushioning
- O-zone full cut
- ArcTech suspension system
- steel rails
- (LxW) 277 x 145mm
- unisex

0.726.920/2 black / coolgrey	003795
0.726.921/0 white / coolgrey	003795







**CLASSIC EXCLUSIV TOURING DS**

- leather
- CrMo rails with double stay
- for candle-type seatposts
- with two compression springs
- (LxW) 270 x 210mm
- unisex

0.726.932/7 coffee	009995
0.726.931/9 gravy	009995
0.726.930/1 honey	009995



**CLASSIC EXCLUSIV TOURING GENTS**

- leather
- CrMo rails
- for candle type seatposts
- with two compression springs
- (LxW) 270 x 210mm
- gents

0.726.935/0 coffee	009995
0.726.934/3 gravy	009995
0.726.933/5 honey	009995



**CLASSIC EXCLUSIV TOURING LADIES**

- leather
- CrMo rails
- for candle-type seatposts
- with two compression springs
- (LxW) 250 x 210mm
- ladies

0.726.938/4 coffee	009995
0.726.937/6 gravy	009995
0.726.936/8 honey	009995



**CLASSIC EXCLUSIV TREKKING**

- leather
- CrMo rails
- for candle type seatposts
- with two compression springs
- (LxW) 280 x 170mm
- unisex

0.726.944/2 coffee	009995
0.726.943/4 gravy	009995
0.726.942/6 honey	009995



**CLASSIC EXCLUSIV TREKKING**

- leather
- CrMo rails
- for candle-type seatposts
- (LxW) 280 x 170mm
- unisex

0.726.941/8 coffee	009995
0.726.940/0 gravy	009995
0.726.939/2 honey	009995



**CLASSIC EXCLUSIV SPORT**

- leather
- CrMo rails
- for candle-type seatposts
- (LxW) 280 x 155mm
- unisex

0.726.947/5 coffee	009995
0.726.946/7 gravy	009995
0.726.945/9 honey	009995







**CHOPPER**

- gel cushioning
- steel rails
- tension and compression spring
- (LxW): 260 x 255mm
- black

0.326.941/2 unisex 004495



**CRUISER COMFORT**

- high density PU-foam cushioning
- O-Zone full cut
- steel rails
- tension and compression spring
- (LxW): 265 x 275mm
- black / grey

0.326.940/4 unisex 003495



**TOP SEAT FOAM**

- saddle cover with comfort pads
- memory foam cushioning
- black / grey

0.327.900/7 for MTB saddle, dimensions (LxW): 290 x 210mm 001595

0.327.901/5 for touring saddle, dimensions (LxW): 260 x 250mm 001595



**TOP SEAT GEL**

- saddle cover with comfort pads
- gel cushioning
- black / grey

0.327.905/6 for MTB saddle, 254-280mm long, 178-203mm wide 001995

0.327.906/4 for touring saddle, 220-254mm long, 216-241mm wide 001995



**TOP SEAT +**

- saddle cover with comfortable gel padding
- special concept foam layer with additional + gel pad
- black

0.327.907/2 for trekking saddle, dimensions approx.: W 190 x L 275mm 001495

0.327.908/0 for city/tour saddles, dimensions approx.: W 220 x L 245mm 001495





**DIAMETER**

Diameter of the handlebar clamp. The diameter of the clamping area must match that the handlebar and stem fit together.



**LENGTH**

Indicates the length of the stem or handlebar.



# SEATPOSTS

## Comfort center

There are more factors involved in a seatpost than you might think: It literally carries you over the ground and is crucial for your riding position, stability, and comfort. Your riding style plays a particularly important role in choosing the ideal seatpost. If, for example, you are a relaxed e-bike rider or even a cargo bike rider, you should take a look at our parallelogram suspension seatpost, Nara Air Link+. If you are more into sporty

riding with an MTB, a dropper seatpost might be just the thing for you. Would you like some more color? Check out our patented seatpost, Kyandi Dango! ... As you can see, CONTEC has a diverse range of seatposts, where everyone can find exactly the right thing. Whether it's for trekking, gravel, road, or cargo bikes.



NARA AIR LINK+ P.174



NARA AIR DLX P.176

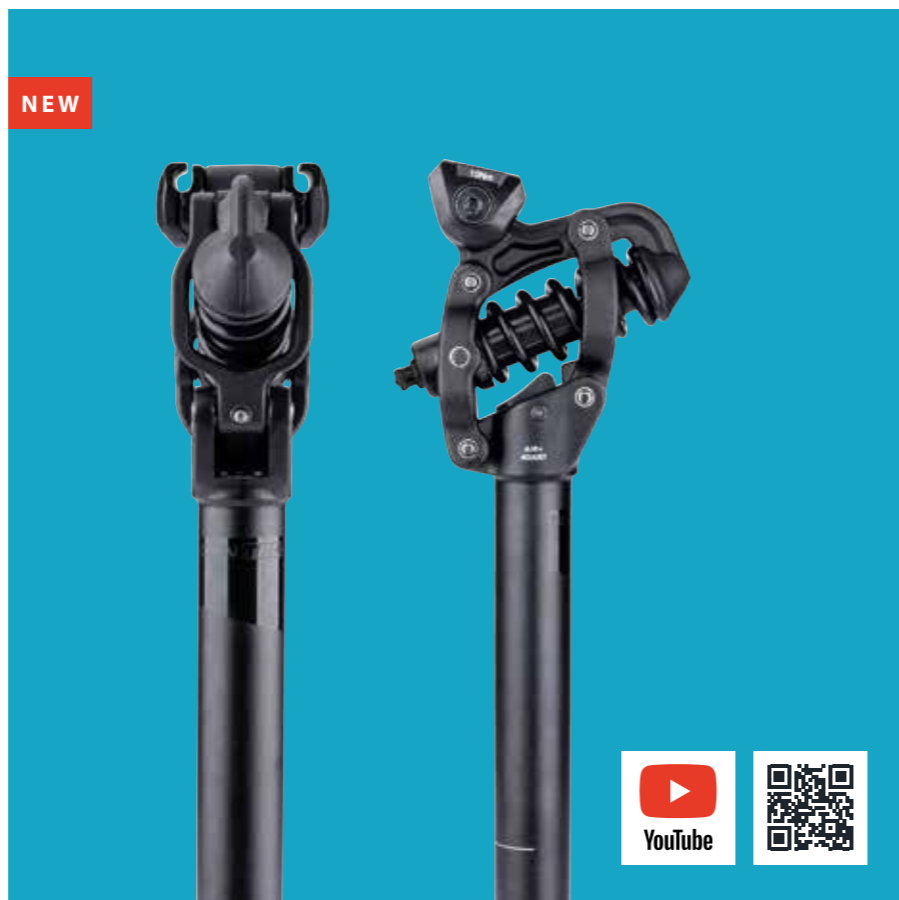

**NARA AIR LINK+**

- parallelogram suspension seatpost
- aluminium 6061
- 58mm travel
- spring rate (40-120kg) individually adjustable via adjustable PSI air suspension
- matt black sandblasted

0.728.993/9	Ø 27,2mm, 300mm long	018995
0.728.994/0	Ø 30,9mm, 300mm long	018995
0.728.994/1	Ø 31,6mm, 300mm long	018995
0.728.994/2	Ø 34,9mm, 300mm long	018995
0.728.991/1	Ø 27,2mm, 350mm long	018995
0.728.992/9	Ø 30,9mm, 350mm long	018995
0.728.993/7	Ø 31,6mm, 350mm long	018995
0.728.993/8	Ø 34,9mm, 350mm long	018995

# Parallelogramm seatposts

The more miles you ride, the higher your need for comfort. And to meet these comfort demands, a parallelogram suspension seatpost like our Nara Air Link+ is just the right thing. Its unique design allows for additional vertical movement of the saddle, which dynamically compensates for even the smallest unevenness. At the same time, the saddle always remains horizontal, so that the feeling arises as if you were gliding over smooth asphalt. Unlike other suspension seatposts,

the Nara Air Link+ is equipped with two suspension systems at once: steel and air suspension. This combination of the two suspensions together with the exceptional parallelogram technology provides the highest level of comfort. A new addition is the Nara Parka! The neoprene cover for our popular Nara Air Link+ not only provides protection from moisture and dirt, but also prevents children in the child seat from reaching into the suspension.



**SP-060 SLIM**

- parallelogram
- aluminium
- 27mm travel
- 70-85kg spring rate
- 585g (27,2 x 350)
- black

0.328.921/2	Ø 27,2mm, 350mm long	008995
0.328.414/8	Ø 27,2mm, 400mm long	008995
0.328.117/7	Ø 30,9mm, 350mm long	008995
0.328.415/5	Ø 30,9mm, 400mm long	008995
0.328.922/0	Ø 31,6mm, 350mm long	008995
0.328.416/3	Ø 31,6mm, 400mm long	008995

**SP-060 SLIM LONG TRAVEL**

- parallelogram
- aluminium
- 36mm travel
- 70-85kg spring rate
- 620g (31,6 x 350)
- black

0.328.923/8	Ø 27,2mm, 350mm long	008995
0.328.417/1	Ø 27,2mm, 400mm long	008995
0.328.118/5	Ø 30,9mm, 350mm long	008995
0.328.418/9	Ø 30,9mm, 400mm long	008995
0.328.924/6	Ø 31,6mm, 350mm long, 620g	008995
0.328.419/7	Ø 31,6mm, 400mm long	008995

**NEW**



**NARA PARKA**

- for parallelogram seatpost Contec Nara Air Link+
- neoprene
- protects from dirt and moisture
- prevents children in the child seat from reaching into the spring

0.328.993/8 black	000995
-------------------	--------

**CLAMP PROTECTION**

- spare protection
- for parallelogram seatpost Contec SP-060 Slim

0.328.179/7 suitable for CONTEC SP-060 Slim	000495
0.728.014/2 suitable for CONTEC SP-060 Slim Long Travel	000495

**SPARE SPRING**

- spare / tuning spring
- for SP-060 Slim / Slim Long Travel parallelogram seatpost

0.328.965/9 extra hard (for approx. 100-130kg), yellow	000595
0.328.967/5 hard (for approx. 85-100kg), black	000595
0.328.966/7 medium (for approx. 70-85kg), silver	000595
0.328.990/7 soft (for approx. 50-70kg), gold	000595





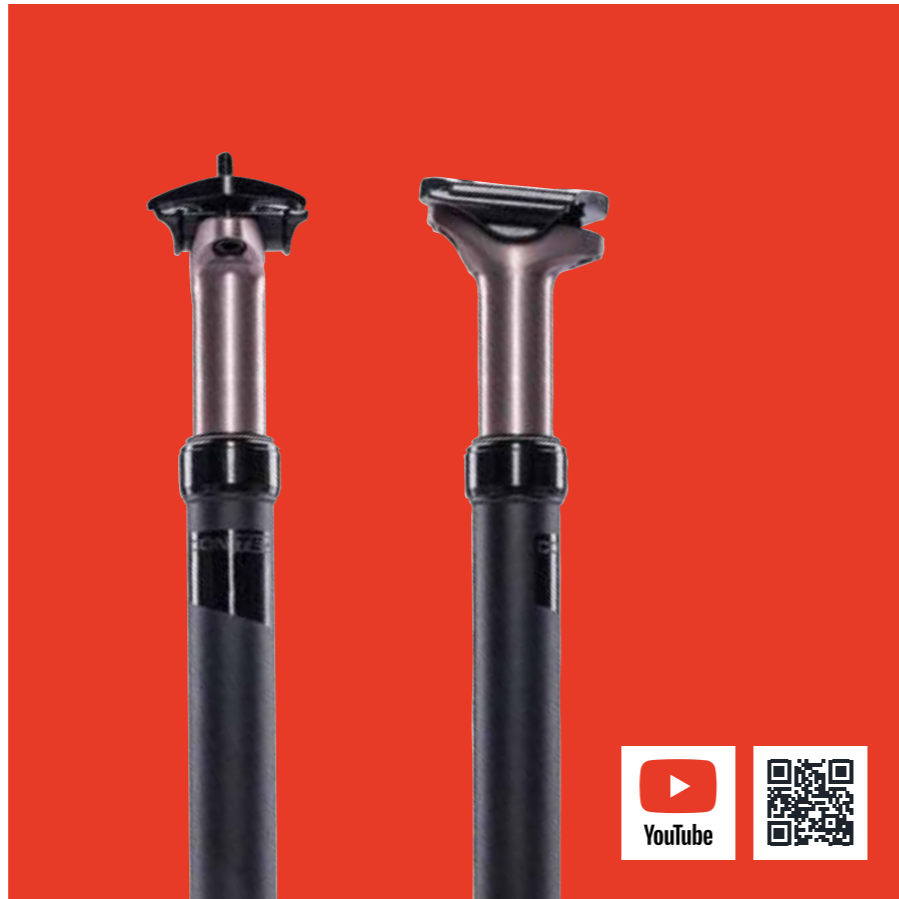
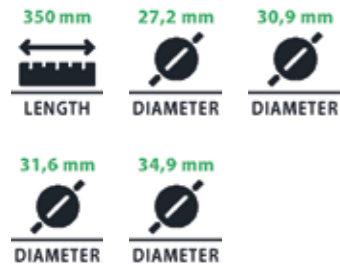

**NARA AIR DLX**

- suspension micro-adjust seatpost
- air suspension
- 350mm long
- 50mm travel
- spring rate up to 120kg
- PTFE coating for smooth height adjustment
- black / taupe

0.728.971/3 Ø 27,2mm	008995
0.728.972/1 Ø 30,9mm	008995
0.728.973/9 Ø 31,6mm	008995
0.728.974/0 Ø 34,9mm	008995

# Suspension seatposts

Cycling is like floating on cloud nine – at least that's exactly what it feels like with our suspension seatposts. In the CONTEC seatpost range you will find various suspension technologies, always with that little extra. For example, our Nara Drop Air DLX offers air suspension in combination with a lowering function. Especially for people who need a little help getting on and off the bike, this is an ideal seatpost that is still incredibly comfortable despite the normally sportier lowering function. We are introducing the entire Nara family on our YouTube channel. Just scan the QR code on the left and watch the video.

**Air suspension** – an air cartridge ensures an immediately responsive spring behavior. This requires only a pump with pressure gauge or a hex wrench.

**Elastomer** – Advantages of these suspension elements made of plastic are the low weight and almost to maintenancefree, as nothing needs to be lubricated.

**Steel spring** – Robust and reliable suspension technology, which is the ideal solution, especially under high loads. Different spring hardnesses help to adapt to the individual rider's weight.



**NARA AIR**

- suspension micro-adjust seatpost
- air suspension
- 350mm long
- 50mm travel
- spring rate up to 120kg
- black

0.728.974/7 Ø 27,2mm	007995
0.728.975/4 Ø 30,9mm	007995
0.728.976/2 Ø 31,6mm	007995
0.728.976/3 Ø 34,9mm	007995

**NARA DLX**

- suspension micro-adjust seatpost
- 350mm long
- 50mm travel
- spring rate up to 120kg
- PTFE coating for smooth height adjustment
- black / taupe

0.728.977/0 Ø 27,2mm	006495
0.728.978/8 Ø 30,9mm	006495
0.728.979/6 Ø 31,6mm	006495



**NARA**

- suspension micro-adjust seatpost
- 350mm long
- 50mm spring
- spring rate up to 120kg
- black

0.728.980/4 Ø 27,2mm	005995
0.728.981/2 Ø 30,9mm	005995
0.728.982/0 Ø 31,6mm	005995

**KANO**

- suspension micro-adjust seatpost
- 350mm long
- 40mm travel
- spring rate up to 120kg
- matt black

0.728.688/3 Ø 27,2mm	003995
0.728.689/1 Ø 30,9mm	003995
0.728.690/9 Ø 31,6mm	003995



**NARA DROP AIR DLX**

- adjustable seatpost
- 40mm travel
- spring rate up to 120kg
- micro-adjust adapter
- PTFE coating for smooth height adjustment
- black / gold

0.728.959/8 Ø 30,9mm, 345mm long, 40mm adjustment range	023995
0.728.961/4 Ø 30,9mm, 402mm long, 80mm adjustment range	023995
0.728.963/0 Ø 30,9mm, 445mm long, 100mm adjustment range	023995
0.728.960/6 Ø 31,6mm, 345mm long, 40mm adjustment range	023995
0.728.962/2 Ø 31,6mm, 402mm long, 80mm adjustment range	023995
0.728.964/8 Ø 31,6mm, 445mm long, 100mm adjustment range	023995
0.728.960/7 Ø 34,9mm, 345mm long, 40mm adjustment range	023995
0.728.962/3 Ø 34,9mm, 402mm long, 80mm adjustment range	023995
0.728.964/9 Ø 34,9mm, 445mm long, 100mm adjustment range	023995



**NARA DROP**

- adjustable seatpost
- 40mm travel
- spring rate up to 120kg
- micro-adjust adapter
- black

0.728.965/5 Ø 30,9mm, 345mm long, 40mm adjustment range	019995
0.728.967/1 Ø 30,9mm, 402mm long, 80mm adjustment range	019995
0.728.969/7 Ø 30,9mm, 445mm long, 100mm adjustment range	019995
0.728.966/3 Ø 31,6mm, 345mm long, 40mm adjustment range	019995
0.728.968/9 Ø 31,6mm, 402mm long, 80mm adjustment range	019995
0.728.970/5 Ø 31,6mm, 445mm long, 100mm adjustment range	019995
0.728.966/4 Ø 34,9mm, 345mm long, 40mm adjustment range	019995
0.728.969/0 Ø 34,9mm, 402mm long, 80mm adjustment range	019995
0.728.970/6 Ø 34,9mm, 445mm long, 100mm adjustment range	019995



**SAGI DROP**

- adjustable seatpost
- aluminium 6061
- 15mm offset
- height adjustment by lever
- adjustment range: 100mm
- 400mm long
- matt black
- 756g

0.728.995/3 Ø 27,2mm	015995
0.728.994/5 Ø 30,9mm	015995
0.728.995/2 Ø 31,6mm	015995

**Adjustable seatposts**

Adjustable seatposts, like our popular Drop-A-Gogo model, offer an ingenious combination of flexibility and stability – all with a high level of comfort. Unlike conventional seatposts, the Drop-A-Gogo can also be easily adjusted in height in seconds while riding. The stepless adjustment of the saddle height is done via a control unit that can be mounted on the bike either as a universal or handlebar lever.

**Dropper suspension seatposts**

Perfectly suited for all those who want to experience comfort not only during the ride, but already when getting on the bike. With our suspension seatposts you get suspension and a lowering function in one package. This means you no longer have to compromise between your ergonomically perfect riding height and a saddle height that allows you to get on and off safely. By the touch of a button you bring your saddle to the level you want. With the additional suspension, the dropper suspension seatposts are also suitable for trekking bikes.



**BIG DROP-A-GOGO**

- adjustable seatpost
- light aluminium 7075
- mechanical handlebar remote incl. 2 levers (1x left and 2/3x left/right)
- internal cable routing
- dust and water repellent sealed
- 80mm insert depth
- 170mm adjustment range
- 565g (30,9 / 170)
- black

0.328.119/3 Ø 30,9mm, 480mm long	024995
0.328.124/3 Ø 31,6mm, 480mm long	024995
0.728.990/3 Ø 34,9mm, 505mm long	024995

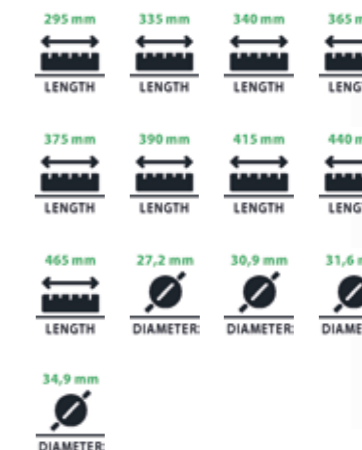

**DROP-A-GOGO**

- adjustable seatpost
- light 7075 aluminium alloy
- stepless height adjustment via low-maintenance and replaceable cartridge
- mechanic remote incl. 2 levers (1x left and 2/3x left/right)
- internal cable routing
- dust and water repellent sealed
- 540g (30,9 / 150 adjusting range)
- black

0.728.983/8 Ø 27,2mm, 295mm long, 60mm adjustment range	024995
0.728.984/6 Ø 27,2mm, 335mm long, 80mm adjustment range	024995
0.728.985/3 Ø 27,2mm, 375mm long, 100mm adjustment range	024995
0.728.986/1 Ø 27,2mm, 450mm long, 125mm adjustment range	024995
0.328.094/8 Ø 30,9mm, 100mm adjustment range, 340mm long	024995
0.328.095/5 Ø 30,9 mm, 125mm adjustment range, 390mm long	024995
0.328.096/3 Ø 30,9mm, 150mm adjustment range, 440mm long	024995
0.328.097/1 Ø 31,6mm, 100mm adjustment range, 340mm long	024995
0.328.098/9 Ø 31,6mm, 125mm adjustment range, 390mm long	024995
0.328.099/7 Ø 31,6mm, 125mm adjustment range, 390mm long	024995
0.728.987/9 Ø 34,9mm, 365mm long, 100mm adjustment range	024995
0.728.988/7 Ø 34,9mm, 415mm long, 125mm adjustment range	024995
0.728.989/5 Ø 34,9mm, 465mm long, 150mm adjustment range	024995



**BRUT VARIO**

- adjustable seatpost
- aluminium 6061
- 15mm offset
- height adjustment over lever
- 100mm adjustment range
- 400mm long
- black
- 756g

0.328.899/0 Ø 30,9mm	015995
0.328.900/6 Ø 31,6mm	015995

NEW



**DROP-A-NARA**

- suitable for handlebar Ø 22,2mm
- suitable for CONTEC adjustable seatpost Nara Dropair DLX and Nara Drop
- black

0.728.968/6 black	003995
-------------------	--------



**DROP-A-ROAD**

- suitable for road handlebars with 24mm handlebar clamp
- and also suitable for CONTEC adjustable seatpost Drop-A-Gogo

0.328.280/0 black	003995
-------------------	--------



**DROP-A-LEVER**

- suitable for handlebar Ø 22,2mm
- and also suitable for CONTEC Drop-A-Gogo adjustable seatpost
- black

0.328.278/7 single lever, classic design (vertical)	003995
0.328.279/5 single lever, Oneby design (horizontal)	003995



**NARA WIRE**

- cable set
- suitable for CONTEC adjustable seatposts Nara Dropair DLX, Nara Drop and Drop-A-Gogo
- consisting of: inner cable, outer casing and endcaps
- black

0.728.968/7 1200mm	000995
0.728.968/8 1500mm	000995
0.728.969/1 1800mm	000995



**BRACER**

- micro-adjust seatpost
- aluminium 6061
- spring rate up to 120kg
- matt black
- approx. 242g

0.728.169/4 Ø 27,2mm, 350mm long	003995
0.728.179/3 Ø 27,2mm, 400mm long	003995
0.728.186/8 Ø 30,9mm, 350mm long	003995
0.728.189/2 Ø 30,9mm, 400mm long	003995
0.728.192/6 Ø 31,6mm, 350mm long	003995
0.728.237/9 Ø 31,6mm, 400mm long	003995
0.728.192/7 Ø 34,9mm, 350mm long	003995
0.728.238/0 Ø 34,9mm, 400mm long	003995



**BRACER OS**

- micro-adjust seatpost
- 20mm offset
- aluminium 6061
- spring rate up to 120kg
- matt black
- approx. 242g

0.728.174/4 Ø 27,2mm, 350mm long	003995
0.728.184/3 Ø 27,2mm, 400mm long	003995
0.728.187/6 Ø 30,9mm, 350mm long	003995
0.728.191/8 Ø 30,9mm, 400mm long	003995
0.728.224/7 Ø 31,6mm, 350mm long	003995
0.728.243/7 Ø 31,6mm, 400mm long	003995
0.728.224/8 Ø 34,9mm, 350mm long	003995
0.728.243/8 Ø 34,9mm, 400mm long	003995



**PILLAR**

- micro-adjust seatpost
- 10mm offset
- aluminium 6061
- spring rate up to 120kg
- black

0.728.244/5 Ø 27,2mm, 350mm long	002995
0.728.249/4 Ø 27,2mm, 400mm long	002995
0.728.309/6 Ø 30,9mm, 350mm long	002995
0.728.310/4 Ø 30,9mm, 400mm long	002995
0.728.318/7 Ø 31,6mm, 350mm long	002995
0.728.319/5 Ø 31,6mm, 400mm long	002995





**PIPE**

- micro-adjust seatpost
- 5mm offset
- aluminium 6061
- spring rate up to 120kg
- black

0.728.323/7 Ø 27,2mm, 350mm long	002495
0.728.324/5 Ø 27,2mm, 400mm long	002495
0.728.325/2 Ø 30,9mm, 350mm long	002495
0.728.329/4 Ø 30,9mm, 400mm long	002495
0.728.338/5 Ø 31,6mm, 350mm long	002495
0.728.350/0 Ø 31,6mm, 400mm long	002495



**KYANDI DANGO**

- micro-adjust seatpost
- Ø 31,6mm
- 350mm long
- aluminium 6061
- 12mm offset
- 2-bolt clamping mechanism
- approx. 315g (31,6 x 350)

0.728.472/2 aoi / black	003995
0.728.473/0 aka / black	003995
0.728.474/8 gure / black	003995
0.728.475/5 midori / black	003995



**BRUT SELECT**

- micro-adjust seatpost
- aluminium 6061
- 2-bolt clamp mechanism
- Ø 27,2 x 350mm
- 346g

0.728.900/2 rocket silver	002995
0.728.901/0 honky white	002995
0.728.903/6 blue steel	002995
0.728.904/4 riot red	002995
0.728.905/1 heart of gold	002995
0.728.906/9 ultra violet	002995
0.728.907/7 guerilla green	002995
0.728.908/5 odd orange	002995



- micro-adjust seatpost
- aluminium 6061
- 2-bolt clamp mechanism
- Ø 31,6 x 350mm
- 355g

0.728.909/3 rocket silver, self-service package	002995
0.728.910/1 honky white, self-service package	002995
0.728.911/9 limousine black, self-service package	002995
0.728.912/7 blue steel, self-service package	002995
0.728.913/5 riot red, self-service package	002995
0.728.914/3 heart of gold, self-service package	002995
0.728.915/0 ultra violet, self-service package	002995
0.728.916/8 guerilla green, self-service package	002995
0.728.917/6 odd orange, self-service package	002995





**RACK SUPPORT**

- aluminium
- 12mm high
- with inside hexagon screw
- matt black
- threaded eyelets for luggage carrier mounting
- 41g

0.328.757/0 Ø 28,6mm	000995
0.328.758/8 Ø 31,8mm	000995
0.328.759/6 Ø 34,9mm	000995



**CLAMP.IT ONE**

- aluminium 7075 T6
- 15mm high
- with inside hexagon screw
- sandblasted black
- 28g (Ø 34,9mm)

0.328.677/0 Ø 31,8mm	000795
0.328.678/8 Ø 34,9mm	000795

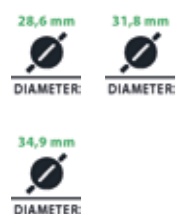

**CLAMP.IT TWO**

- aluminium 7075 T6
- 11mm high
- with inside hexagon screw
- sandblasted black
- 18g (Ø 34,9mm)

0.328.679/6 Ø 28,6mm	000695
0.328.680/4 Ø 31,8mm	000695
0.328.681/2 Ø 34,9mm	000695



**CLAMP.IT THREE**

- aluminium 6061
- suitable for carbon seatposts
- 11mm high
- with inside hexagon screw
- sandblasted black
- 14g

0.328.682/0 Ø 31,8mm	000795
0.328.683/8 Ø 34,9mm	000795



**JAM.IT ONE QR**

- aluminium
- 15mm high
- with QR
- sandblasted black
- 41g (Ø 34,9mm)

0.328.684/6 Ø 28,6mm	000795
0.328.685/3 Ø 31,8mm	000795
0.328.686/1 Ø 34,9mm	000795



**JAM.IT TWO QR**

- aluminium 6061
- 15mm high
- with QR
- sandblasted black
- 41g (Ø 34,9mm)

0.328.687/9 Ø 31,8mm	000895
0.328.688/7 Ø 34,9mm	000895



**JAM.IT THREE QR**

- aluminium 6061
- 15mm high
- with QR
- sandblasted black
- 37g (Ø 34,9mm)

0.328.689/5 Ø 31,8mm	000695
0.328.690/3 Ø 34,9mm	000695



**SC-303 QR SELECT**

- 15mm high
- aluminium 6061 T6
- with QR
- Ø 31,8mm
- 36g

0.328.942/8 rocket silver	000895
0.328.943/6 honky white	000895
0.328.944/4 limousine black	000895
0.328.947/7 heart of gold	000895
0.328.950/1 odd orange	000895

- 15mm high
- aluminium 6061 T6
- with QR
- Ø 34,9mm
- 36g

0.328.968/3 rocket silver	000895
0.328.969/1 honky white	000895
0.328.986/5 limousine black	000895
0.328.987/3 blue steel	000895
0.328.997/2 ultra violet	000895



**SC-200 SELECT**

- aluminium 7075 T6
- 15mm high
- with inside hexagon screw
- Ø 34,9mm
- 28g

0.328.876/8 blue steel	000795
0.328.877/6 riot red	000795
0.328.878/4 heart of gold	000795
0.328.879/2 ultra violet	000795
0.328.881/8 odd orange	000795

- aluminium 7075 T6
- 15mm high
- with inside hexagon screw
- Ø 31,8mm
- 28g

0.328.864/4 rocket silver	000795
0.328.867/7 blue steel	000795
0.328.869/3 heart of gold	000795
0.328.871/9 guerilla green	000795
0.328.872/7 odd orange	000795



**SC-301 QR**

- aluminium 6061 T6
- with QR
- black
- 38g

0.328.982/4 Ø 31,8mm	001095
0.328.983/2 Ø 34,9mm	001095



**SC-302 QR**

- aluminium 6061 T6
- with QR
- 39g

0.328.978/2 Ø 31,8mm, black	000895
0.328.979/0 Ø 34,9mm, black	000895
0.328.980/8 Ø 31,8mm, silver	000895
0.328.981/6 Ø 34,9mm, silver	000895



**SC-303 QR**

- aluminium 6061 T6
- with QR
- 36g

0.328.975/8 Ø 28,6mm, silver	000795
0.328.976/6 Ø 31,8mm, silver	000795
0.328.977/4 Ø 34,9mm, silver	000795



**SC-304 QR**

- aluminium 6061 T6
- with QR
- black
- 47g

0.328.904/8 Ø 31,8mm	000895
0.328.905/5 Ø 34,9mm	000895





**LHOTSE**

- aluminium 7075 with different material textures
- 13mm high
- with inside hexagon screw
- 18g

0.328.953/5 Ø 31,8mm	000995
0.328.954/3 Ø 34,9mm	000995



**SC-209**

- aluminium 6061
- suitable for carbon seatposts
- 11mm high
- with inside hexagon screw
- 14g

0.328.961/8 Ø 31,8mm	000895
0.328.963/4 Ø 34,9mm	000895



**SC-100**

- aluminium 7075 T6
- 11mm high
- with inside hexagon screw
- 18g

0.328.955/0 Ø 28,6mm, black	000695
0.328.956/8 Ø 28,6mm, silver	000695
0.328.958/4 Ø 31,8mm, silver	000695
0.328.960/0 Ø 34,9mm, silver	000695



**SC-250**

- aluminium 6061, CrMo bolts
- M8 x 55mm
- with aluminium sleeve
- 35g

0.342.911/5 black	000595
0.342.912/3 silver	000595

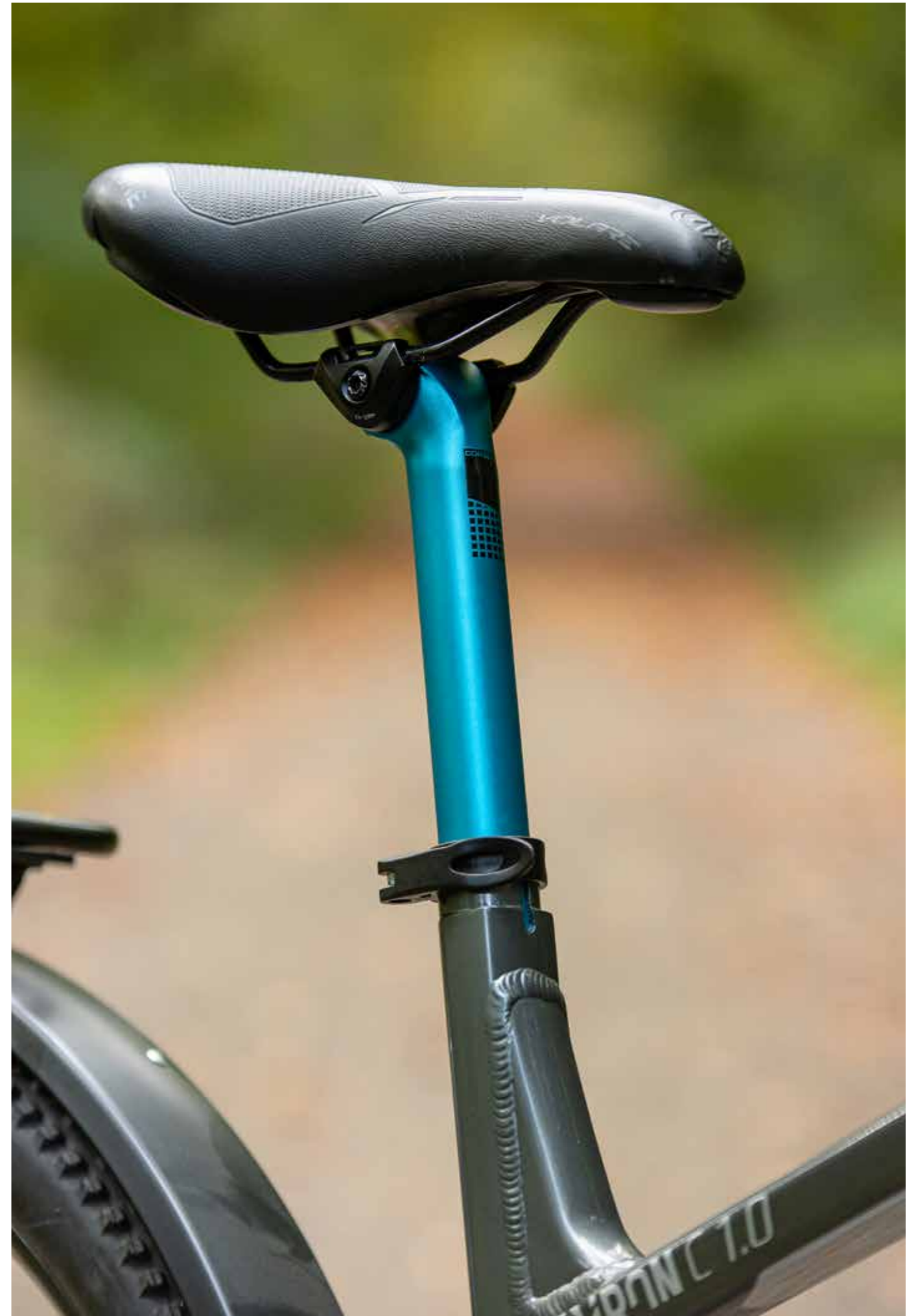





WATER PROOF

Waterproof for the ideal protection of your e-bike components from weather conditions.



PROTECTION

Stone chip protection for your components while riding or transporting on a bike rack.



E-READY

Suitable for your e-bike, to protect your e-bike components such as motor, battery or display.



WINTER

Protects your e-bike battery from low temperatures and prevents range loss due to cold weather.



## E-BIKE PROTECTION

# E-bike protection Neo.Protect

When transporting on the roof or rear rack, the electronic components of your e-bike are often exposed to wind and weather without protection. To protect components such as engine, handlebar, battery, display and contacts, our Neo. Protect collection is an innovative system of protective sleeves that allow you to protect your E-bike from weather or damage. The waterproof neoprene prevents the penetration of water and dirt and the soft material acts as a shock absorber against stone chips. But the possible useage doesn't end at the

rear rack: For example in cold weather, the battery protection sleeve isolates the sensitive lithium-ion cells, thus reduces the temperature-related faster discharge of the cells.

**TIP:** The battery protection should not be used while driving at temperatures above 15°C, as this can lead to overheating and thus shutdown of the system.



BATTERY.PROTECT P.192



NEO.PROTECT DISPLAYTASCHE P.193

NEW



**BATTERY.PROTECT**

- fireproof outside fabric, webbing and twine
- rolltop closure with metal hook
- padded inner sleeve: 100g, made of neoprene (SBR)
- outer pocket: 230g, made of silicone coated fiberglass fabric
- battery dimensions: maximum circumference of 37cm and a maximum length of 50cm
- suitable for Intube, rack and frame batteries from various manufacturers such as Bosch and Shimano

0.329.659/0 004995



**NEO.PROTECT**

- motor protection for all common mid-motors
- made of neoprene, protect against splashwater and damage during transport
- easy assembly via all-round Velcros
- more flexibility due to individual shortening Velcro straps

0.329.650/6 black / coolgrey 003495



**NEO.PROTECT DOWNTUBE**

- battery protection for integrated frame batteries
- made of neoprene, protects against splashwater and damage during transport
- easy and universal assembly via Velcro closure
- black / coolgrey

0.329.653/1 scope: 32 - 45cm 003495



**NEO.PROTECT BOSCH**

- for Bosch frame batteries
- made of neoprene, protects against splashwater and damage during transport
- fits for Bosch batteries

0.329.655/5 black / coolgrey 002995



**NEO.PROTECT UNI**

- for frame batteries
- made of neoprene, protects against splashwater and damage during transport
- suitable for all common frame batteries

0.329.656/3 black / coolgrey 002995



**NEO.PROTECT**

- for carrier batteries
- made of neoprene, protects against splashwater and damage during transport

0.329.654/8 black / coolgrey 002995



**NEO.PROTECT**

- handlebar cover to protect the cockpits
- made of water repellent PU to protect against water during transport or storage
- easy attachment by Velcro on the underside and two all-round Velcro closures

0.329.651/4 black 002495



**NEO.PROTECT**

- contact protection for covering the connection contacts on the frame when the battery is removed
- made of neoprene to protect against splashwater and damage during transport or storage
- easy assembly via all-round Velcros
- more flexibility due to individual shortening of Velcro straps

0.329.652/2 black / coolgrey 001695



**NEO.PROTECT**

- bag for all common display and board computer
- made of neoprene, soft inlining protects the display during transport
- incl. snap hooks for the key

0.329.657/1 black / coolgrey 001495



**COVER.IT**

- silicone cover for E-bike displays, incl. protective foil
- protects even from heavy rain
- scratch resistant, e.g. against keys and other sharp-edged objects
- display can still be used without restrictions
- black

0.329.658/0 suitable for Bosch Intuvia 100 display 001495

0.329.658/1 suitable for Bosch Kiox 300 display 001495





BAR / PSI

Indicates the maximum air pressure in BAR or PSI that the pump can deliver.



BOTTLE CAGE

The supplied bracket allows the pump to be mounted under the bottle cage or on the bottle cage eyelets.



## PUMPS

### Flat tire?

Pumps come in all colors and shapes, but they should above all one things: inflate your bike tire quickly and easily. So you don't have to think more than necessary when choosing a pump, because many of our Air Support pumps are equipped with a twin head that fits the two most common valves AV and DV / SV.

The floor pumps with pressure gauge are the ideal choice for filling tires before the next tour. At the trip, it's all about light weight, high pumping power and maximum ease of use. Our Air Support Pocket mini pumps provide air support. They offer a wide range of different models for different purposes - either a lot of pressure for racing bike tires or a lot of volume for city bikes. With their extendable hose and the multi-valve head pumping is very simple.



- Twin valve**  
twin head with 2 connectors – suitable for AV and DS/SV
- Clever valve**  
reversible insert AV and DV/SV valve
- Flip valve**  
easy operating via button on the lever



AIR SUPPORT STEALTH P.196



AIR SUPPORT SHOCK PRO P.199



**AIR SUPPORT STEALTH**

- aluminium barrel / steel base
- clever valve - suitable for all valves
- Kraton rubber coated T-grip
- incl. ball and air mattress adapter
- extra large 3" gauge

0.331.947/2 black 006995



**AIR SUPPORT MOUNTAIN**

- steel barrel / plastic foot
- especially for high-volume MTB tires
- twin head - suitable for all valves
- Kraton rubber covered T-handle
- incl. ball and mattress adapter
- gauge

0.331.066/1 black / coolgrey 003995



**AIR SUPPORT SPORT**

- steel barrel / plastic foot
- twin head - suitable for all valves
- Kraton rubber covered T-handle
- incl. ball and mattress adapter
- gauge

0.331.061/2 black / coolgrey 003495  
 0.331.062/0 black / neored 003495  
 0.331.063/8 black / neoblue 003495  
 0.331.064/6 black / neogreen 003495  
 0.331.065/3 black / neoyellow 003495



**AIR SUPPORT G-FORCE**

- 8,3 bar / 120 psi
- AV & SV
- flexible pump hose with integrated pressure gauge
- aluminium housing with stainless steel foot
- length: 250mm, 175g

0.331.733/6 black 005995



**AIR SUPPORT POCKET PRO GAUGE**

- 8,3 bar / 120 psi
- AV & SV
- flexible pump hose with integrated pressure gauge
- aluminium housing
- length: 225mm, weight: 128g

0.331.732/8 black 004495



**AIR SUPPORT POCKET STEALTH**

- aluminium
- FlipValve pump head system, easy operating via lever on the head
- FlipValve Head is connected with the flexible hose and can be pulled out up to 15cm
- incl. bracket
- dust cap
- HV (High Volume)
- length: 225mm, weight: 180g

0.331.999/3 matt black 002995



**AIR SUPPORT POCKET**

- aluminium / plastic
- FlipValve pump head system, simple operation via a lever on the head
- FlipValve Head is connected with the flexible hose and can be pulled out up to 15cm
- incl. bracket
- dust cap
- HP (High Pressure)
- length: 210mm, weight: 170g

0.331.990/2 red 002195  
 0.331.992/8 yellow 002195  
 0.331.991/0 blue 002195  
 0.331.993/6 silver 002195  
 0.331.994/4 black 002195



**AIR SUPPORT POCKET NEO 80**

- light thermoplastic housing
- high volume - less pump strokes
- for all valves
- FlipValve pump head system, simple operation via a lever on the head
- FlipValve head is connected with the flexible hose and can be pulled out up to 15cm
- incl. bracket
- length: 225mm, weight: 150g

0.331.890/4 black / coolgrey	001795
0.331.891/2 black / neored	001795
0.331.892/0 black / neoblue	001795
0.331.893/8 black / neoyellow	001795
0.331.894/6 black / neogreen	001795



**AIR SUPPORT POCKET NEO 100**

- light thermoplastic housing
- high pressure - less pump strokes
- for all valves
- FlipValve pump head system, simple operation via a lever on the head
- FlipValve head is connected with the flexible hose and can be pulled out up to 15cm
- incl. bracket
- length: 220mm, weight: 140g

0.331.895/3 black / coolgrey	001795
0.331.896/1 black / neored	001795
0.331.897/9 black / neoblue	001795
0.331.898/7 black / neoyellow	001795
0.331.899/5 black / neogreen	001795



**SQUEEZ II**

- plastic
- foldable T-handle
- reversible valve insert - suitable for all valves
- incl. bracket
- length: 230mm, weight: 152g

0.331.006/7 black	000595
-------------------	--------



**AIR SUPPORT SHOCK PRO**

- 20 bar / 300 psi
- AV
- flexible pump hose with integrated pressure gauge
- aluminium housing
- length: 230mm, 85g

0.331.734/4 black	004995
-------------------	--------



**SHOCKROCKET**

- aluminium
- Schrader valve
- no pressure lost over 2-stage valve
- 360° rotatable hose
- pressure regulating via air-release button
- 1,5" pressure gauge
- black / silver

0.331.916/7 max. 28 bar / 400 psi	003495
-----------------------------------	--------

0.331.916/8 max. 41 bar / 600 psi	004995
-----------------------------------	--------



**AIR SUPPORT ATTACHÉ**

- plastic
- universal head - suitable for all valves
- frame clamp - 3 different fitting lengths

0.331.919/1 414-480mm installation width, size S	000995
--	--------

0.331.918/3 460-530mm installation width, size M	000995
--	--------

0.331.917/5 514-580mm installation width, size L	000995
--	--------



**AIR SUPPORT CO2 GUN**

- AV & SV valve
- for CO2 cartridges with thread up to 25g
- aluminium 7045 T6 pump head with air flow control lever and CNC-machined aluminium housing
- length: 145mm, 70g

0.331.735/1 black	003995
-------------------	--------





**INFLATOR MICRO**

- minimalist CO2 cartridge attachment, fits in every jersey pocket
- dosing is initiated or stopped by turning the cartridge
- length: 110mm, weight: 100g

0.331.905/0 incl. 16g CO2 cartridge	001995
-------------------------------------	--------

**2**  
PIECES

**5**  
PIECES



**CO2 SPARE CARTRIDGE**

- with thread e.g. for Contec Air Support CO2 Gun
- 25g

0.331.958/9 2 pieces	001295
0.331.959/7 5 pieces	002595

**2**  
PIECES

**5**  
PIECES



**CO2 SPARE CARTRIDGE**

- with thread e.g. for Contec Inflator Micro
- 16g

0.331.914/2 2 pieces	000895
0.331.915/9 5 pieces	001595



**BALL AV**

- suitable for AV pump

0.331.736/9 suitable for AV pump	000295
----------------------------------	--------



**VALVE CAP**

- fits for Schrader valves
- pair

0.331.900/1 bullet, aluminium, assorted colours (black, red, silver, blue and gold)	000495
0.330.900/2 skull & bones, plastic, chrome	000495
0.330.901/0 skull, plastic, chrome	000495
0.330.902/8 8 ball, aluminium, black	000595
0.330.903/6 gambler, aluminium, chrome	000595
0.330.904/4 gambler, aluminium, black	000595



**VALVE ADAPTER**

- reducing / enlarging nippel
- outgoing from the pump

0.331.906/8 from DV / SV to AV	000395
0.331.907/6 from AV to DV / SV	000395
0.331.908/4 from DV-pump to SV-valve	000395



**LEISURE**

- valve adapter set

0.331.913/4 various adapter pieces for the leisure range (ball, air mattress etc.)	000495
--	--------

NEW

2  
PIECES10  
PIECES**VALVE AV**

·Schrader valve

0.330.921/3 2 pieces

000195

0.330.921/4 package with 10 pieces

000995

NEW

2  
PIECES10  
PIECES**VALVE DV**

·Dunlop valve

0.330.912/7 set with 2 pieces

000395

0.330.921/0 in bag with 10 pieces (=MOQ), price per 10 pieces

000995

NEW

2  
PIECES10  
PIECES**VALVE SV**

·Scaverand valve

0.330.921/1 2 pieces

000295

0.330.921/2 package with 10 pieces

001095

**VALVE UNI**

·each 1 adapter AV, DV, SV

0.331.808/6 set

000395

**ANGLE AV**

·angle adapter

0.331.809/4 for AV

000795

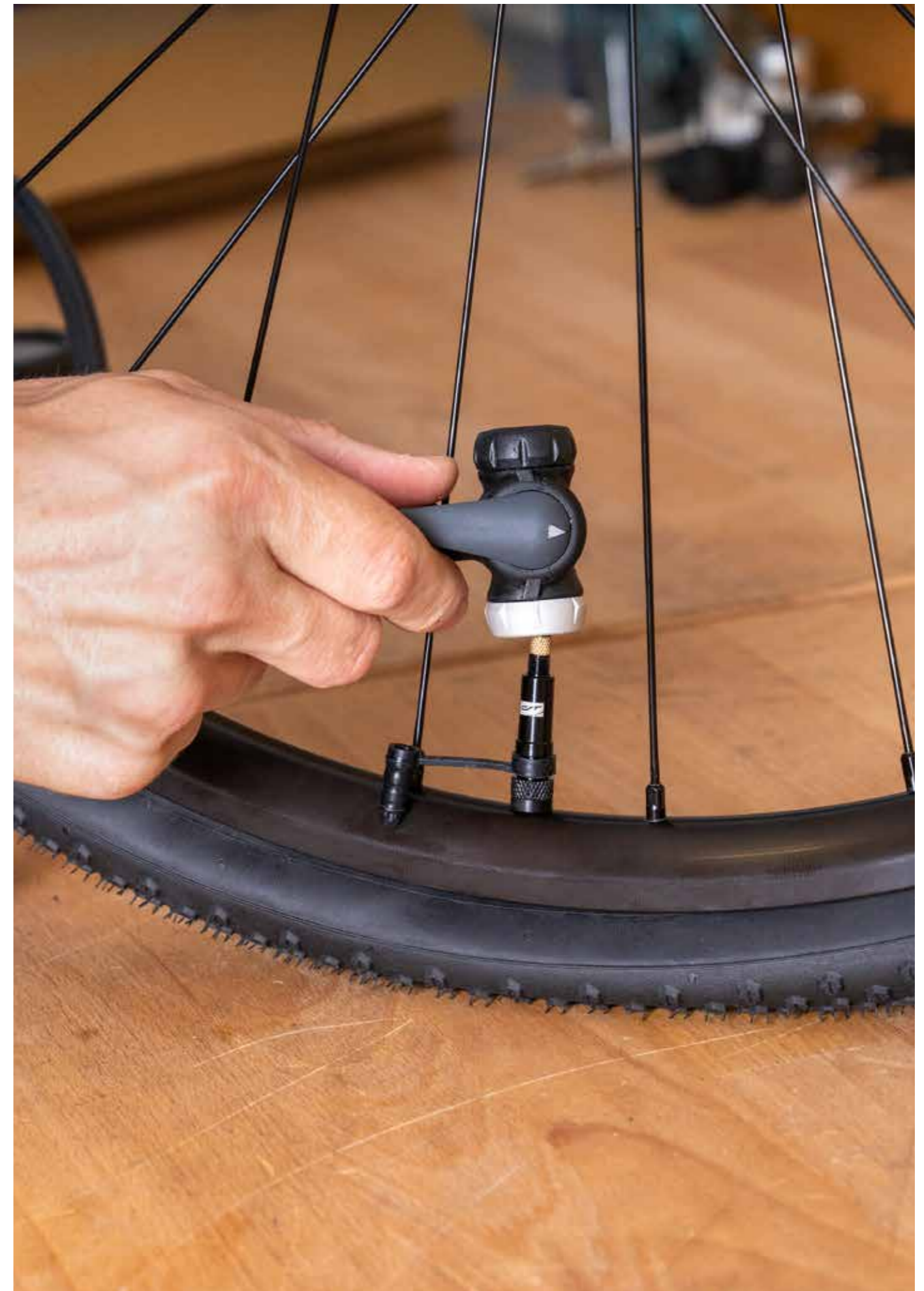





## BOTTOM BRACKET

# Step by step, pedal by pedal

Riding a bike is a relaxing activity. At least as long as the bike runs quietly and smoothly. Because as soon as a central component, such as the bottom bracket, cracks, the bike ride can quickly become an ordeal. Time to replace it. Our BOX.Fit bottom bracket can not completely relieve you of the work, but make the installation much easier: Because for our two-piece Pressfit bottom bracket you no longer need a press tool! Instead, they can be easily screwed and thus automatically pulled into the frame. All you need are two bottom bracket

wrenches, such as our TFP-140. We show you how this looks in practice on our YouTube channel. Simply scan the QR code on the next page and go to our channel, where you will find a how-to video on our BOX.Fit bottom brackets. By the way: As BOX.Thread we now also offer our bottom bracket with an external bearing shell for SRAM GXP, SHIMANO Hollowtech II and SRAM DUB with the bearing shells made of the same hardened aluminum as our BOX.Fit bearings.



BOX.FIT BB30 P.206



BOX.FIT BB86/92 P.207



# Relaxed riding without any noise

## BOX.FIT BB30

- BB30
- 68/73mm housing width
- 42mm bearing diameter
- 2-piece thread design, can be used instead of a standard Pressfit inner bearing
- self-adjusting for more accurate alignment and longer life

0.832.911/2 BB30-24, suitable for SHIMANO Hollowtech II, axle diameter: 24mm	004995
0.832.912/0 BB30-29, suitable for SRAM DUB, axle diameter: 29mm	004995



## BOX.FIT BB86/92

- BB86/92
- 86/92mm housing width
- bearing diameter 41mm
- 2-piece thread design, can be used instead of a standard Pressfit inner bearing
- self-adjusting for more accurate alignment and longer life

0.832.918/7 BB86/92-24, suitable for SHIMANO Hollowtech II, axle diameter 24mm	004995
0.832.919/5 BB86/92-24/22, suitable for SRAM GXP, axle diameter 24/22mm	004995
0.832.920/3 BB86/92-29, suitable for SRAM DUB, axle diameter 29mm	004995



## BOX.FIT BB386

- BB386
- bearing diameter 46mm
- 2-piece thread design, can be used instead of a standard Pressfit inner bearing
- self-adjusting for more accurate alignment and longer life

0.832.921/1 BB386-24, suitable for SHIMANO Hollowtech II, axle diameter 24mm, 86,5mm housing width	004995
0.832.922/9 BB386-29, suitable for SRAM DUB, axle diameter 29mm, 86/92mm housing width	004995



## BOX.FIT PF30

- Pressfit 30
- 68/73mm housing width
- bearing diameter 46mm
- 2-piece thread design, can be used instead of a standard Pressfit inner bearing
- self-adjusting for more accurate alignment and longer life

0.832.913/8 PF30-24, suitable for SHIMANO Hollowtech II, axle diameter 24mm	004995
0.832.914/6 PF-30-29, suitable for SRAM DUB, axle diameter 29mm	004995

## BOX.THREAD BSA

- BSA
- 68/73mm housing width
- bearing diameter 37mm

0.832.915/3 BSA-24, suitable for SHIMANO Hollowtech II, 24mm axle diameter	003495
0.832.916/1 BSA-24/22, suitable for SRAM GXP, axle diameter 24/22mm	003495
0.832.917/9 BSA-29, suitable for SRAM DUB, axle diameter 29mm	003995





**CBB-150**

- square tapered, universal repair-bottom bracket (replaced BSA, ITA, French and very rare thread)
- sealed bearings
- stainless steel
- the conical bearing shells are screwed
- 360g

0.332.680/8 110mm	002995
0.332.681/6 113mm	002995
0.332.682/4 116mm	002995
0.332.683/2 119mm	002995
0.332.684/0 122,5mm	002995
0.332.685/7 124,5mm	002995
0.332.686/5 127,5mm	002995

**CBB-100**

- square, JIS
- BSA (1,37" x 24/68mm)
- sealed cartridge bearings
- boron steel axle
- different axle widths
- 280g

0.332.994/3 107mm	001995
0.332.995/0 110,5mm	001995
0.332.996/8 113mm	001995
0.332.989/3 115mm	001995
0.332.997/6 118mm	001995
0.332.998/4 122,5mm	001995
0.332.979/4 124,5mm	001995
0.332.999/2 127,5mm	001995

**CBB-050**

- square, JIS
- BSA (1,37" x 24/68mm)
- industrial sealed bearings
- boron steel axle
- nylon bearing shells
- different axle lengths
- 280g

0.332.292/2 118mm	001495
0.332.295/5 120mm	001495
0.332.299/7 122,5mm	001495
0.332.331/8 124,5mm	001495
0.332.338/3 126mm	001495
0.332.340/9 127,5mm	001495





TEETH

This icon indicates the number of teeth of a chain ring or sprocket or the compatibility with other components with this number of teeth.



E-READY

These components are specially designed for use on e-bikes.

# CHAIN RINGS

## Shiny teeth

Due to the high motor torques and other forces acting on e-bikes, e-cargo bikes and especially on e-MTBs for demanding terrain, drive components and gears are regularly subjected to high stress. Therefore, e-bike chain rings

and sprockets – especially with high mileage - are subject to natural wear. Our components for e-bikes from BOSCH generations I-III offer a reliable replacement solution made of high-quality 7075-T6 aluminum and steel.



### B-DM

- for Bosch Gen.3
- direct mount
- chainline 47,5mm
- Chainglider compatible
- aluminium 7075

0.833.064/9 38 teeth	004495
0.833.065/6 42 teeth	004495
0.833.066/4 44 teeth	004495



### B-SP

- for Bosch Gen.1, 3 and 4
- 104mm circle diameter
- aluminium 7075

0.833.059/9 36 teeth	003995
0.833.060/7 38 teeth	003995
0.833.061/5 40 teeth	003995
0.833.062/3 42 teeth	003995
0.833.063/1 44 teeth	003995

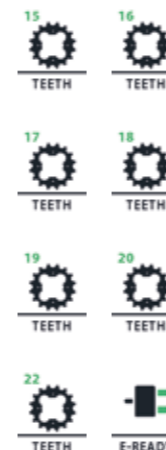

### SPROCKET-B

- for Bosch from mod.14
- steel

0.337.088/9 15 teeth	001495
0.337.089/7 16 teeth	001495
0.337.090/5 17 teeth	001495
0.337.091/3 18 teeth	001495
0.337.092/1 19 teeth	001495
0.337.093/9 20 teeth	001495
0.337.094/7 22 teeth	001495





#### GEARSHIFT

Compatible for derailleurs with the designated number of sprockets on the rear wheel.



#### E-READY

Due to its design, this chain is particularly suitable for the high torques of e-bike drives.



#### ENVIRONMENT

This chain has an environmentally friendly anti-rust coating.



#### CHAIN

This icon indicates how many links are present on a chain.



## CHAINS

# The chain is the heart of your bicycle drive.

No matter if it is a single speed, internal gear hub, 11-speed or an e-bike chain. The bicycle chain transfers the strength to the rear wheel which the driver raises when pedaling, which sets the bike and rider in motion.

The bicycle chain is exposed to particularly high stress, for example when cycling through muscle power and also to a greater degree on e-bikes. Added to this are weather, moisture and dirt resistance, which further increases the demands required on a bike chain.

To enjoy the smooth and quiet running of your bike for as long as possible, we at CONTEC offer you a wide range of bicycle chains, from which you can choose the right chain for your bike. Our CONTEC chains are specially adapted for the respective application, as you can see from the name suffix.

For professional users, we also offer our chains as a workshop box, which can be cut to length in a resource-saving manner.

While we are on the subject of ecology: many of our chains have our Green Power label and indicate the special anti-rust coating used here. These chains do not use environmentally harmful additives for rust protection, which are usually used for chains. You do not have to worry about a loss of performance – the Green Power anti-rust coating is, in fact, more durable than other conventional anti-rust coating.

Our basic assortment for single speed, internal gear hubs and derailleurs. Corrosion protection, incl. connecting link.

#### Green Power

Our chain with environmentally friendly anti-rust coating. For single speed/internal gear hubs and derailleurs. Incl. connecting link for easy assembly.

#### Enhanced Drive

For increased demands on durability and for E-bikes. Longlife-chains, thanks to a special coating and hardened rivets. Particularly resistant. Suitable for E-bikes with midmotors (Bosch, Shimano, etc.). 11-speed chain for modern 11-speed derailleur E-MTB's. Environmentally friendly anti-rust coating.

#### Heavy Duty

More performance and improved durability through reinforced pins and links, improved smooth running, with connecting link.

#### Race

Optimized for performance and lightweight, to give everything when racing and training. More power, less weight. With special hardened coating for road bikes and MTB's

Classic



**CLASSIC SINGLESPEED**

- single speed
- incl. connecting link
- black

0.334.940/4 C.1, 1/2" x 1/8", 112 links, self-service package	000895
0.334.983/4 C.1, 1/2" x 1/8", workshop package with 30m (2364 links), incl. 25 connecting links	015995
0.334.941/2 C.1N, 1/2" x 3/32", 116 links, self-service package	000895
0.334.984/2 C.1N, 1/2" x 3/32", workshop package with 30m (2364 links), incl. 25 connecting links	015995



**GREEN POWER**

- single speed
- with environmentally anti-rust coating
- incl. connecting link
- titanium grey

0.334.960/2 GP.1, 1/2" x 1/8", 112 links, self-service package	001195
0.334.991/7 GP.1, 1/2" x 1/8", workshop package with 30m (2364 links), incl. 25 connecting links	020995
0.334.961/0 GP.1N, 1/2" x 3/32", 112 links, self-service package	001195
0.334.992/5 GP.1N, 1/2" x 3/32", workshop package with 30m (2364 links), incl. 25 connecting links	020995



**ENHANCED DRIVE**

- single speed
- longlife chain due to special coating
- incl. connecting link
- silver

0.334.965/1 eD.1, 1/2" x 1/8", 128 links	001695
0.334.966/9 eD.1N, 1/2" x 3/32", 136 links	001995



**ENHANCED DRIVE +**

- single speed
- longlife chain due to special coating
- with environmentally anti-rust coating
- incl. connecting link
- titanium grey

0.334.971/9 eD.1+, 1/2" x 1/8", 128 links, self-service package	001995
0.334.996/6 eD.1+, 1/2" x 1/8", workshop package with 30m (2364 links), incl. 25 connecting links	037995
0.334.972/7 eD.1N+, 1/2" x 3/32", 136 links, self-service package	002595



**HEAVY DUTY**

- single speed
- more performance and improved durability over reinforced pins and links
- improved smoothness
- 112 links, incl. connecting link
- silver / black

0.334.980/0 HD.K1, 1/2" x 1/8"	001095
0.334.981/8 HD.1N, 1/2" x 3/32"	001095



**HEAVY DUTY HD.S1**

- halflink, single speed, 1/2" x 1 1/8"
- more performance and better durability via reinforced pins and links
- improved smoothness
- 112 links incl. connecting link

0.334.982/6 silver / silver	001995
-----------------------------	--------

7-speed Chains



**CLASSIC C.7**

- 1/2" x 3/32"
- incl. connecting link
- 7-speed
- black / black

0.334.942/0 116 links	000995
0.334.985/9 workshop package with 30m (2364 links), incl. 25 connecting links	017995



**GREEN POWER GP.7**

- 1/2" x 3/32"
- with environmentally friendly antirust coating
- incl. connecting link
- 7-speed
- titanium-grey

0.334.962/8 116 links	001295
0.334.993/3 workshop package with 30m (2364 links), incl. 25 connecting links	020995





**CLASSIC C.8**

- 1/2" x 3/32"
- incl. connecting link
- 8-speed
- silver / silver

0.334.943/8 116 links	001295
0.334.986/7 workshop package with 30m (2364 links), incl. 25 connecting links	023995



**GREEN POWER GP.8**

- 1/2" x 3/32"
- with environmentally anti-rust coating
- incl. connecting link
- 8-speed
- titanium-grey

0.334.963/6 116 links	001695
0.334.994/1 workshop package with 30m (2364 links), incl. 25 connecting links	030995



**ENHANCED DRIVE ED.8**

- 1/2" x 3/32"
- longlife chain due to special coating
- 136 links, incl. connecting link
- 8-speed

0.334.967/7 silver / silver	001995
-----------------------------	--------



**ENHANCED DRIVE ED.8+**

- 1/2" x 3/32"
- longlife chain due to special coating
- with environmentally anti-rust coating
- 136 links, incl. connecting link
- 8-speed

0.334.973/5 titanium grey	002995
---------------------------	--------



**CLASSIC C.9**

- 1/2" x 11/128"
- incl. connecting link
- 9-speed
- silver / silver

0.334.944/6 self-service package, 116 links	001995
0.334.987/5 workshop package with 30m (2364 links), incl. 25 connecting links	035995



**GREEN POWER GP.9**

- 1/2" x 11/128"
- with environmentally anti-rust coating
- incl. connecting link
- 9-speed
- titanium grey

0.334.964/4 self-service package, 116 links	001995
0.334.995/8 workshop package with 30m (2364 links), incl. 25 connecting links	037595



**ENHANCED DRIVE ED.9**

- 1/2" x 11/128"
- longlife chain due to special coating
- 136 links, incl. connecting link
- 9-speed

0.334.968/5 silver / silver	002595
-----------------------------	--------



**ENHANCED DRIVE ED.9+**

- 1/2" x 11/128"
- longlife chain due to special coating
- with environmentally anti-rust coating
- 136 links, incl. connecting link
- 9-speed

0.334.974/3 136 links	002995
0.334.974/4 workshop package with 30m (2364 links), incl. 25 connecting links	069900





**RACE R.9**

- 1/2" x 11/128"
- with Race Performance - better performance with less weight
- ultrahard and ultralight
- 116 links, incl. connecting link
- 9-speed

0.334.977/6 silver / silver 003995



**CLASSIC C.10**

- 1/2" x 11/128" (5/64")
- 116 links incl. connecting link
- 10-speed

0.334.945/3 116 links 002495

0.334.945/4 workshop package with 30m (2364 links), incl. 25 connecting links 059900



**ENHANCED DRIVE ED.10**

- 1/2" x 11/128"
- longlife chain due to special coating
- 136 links, incl. connecting link
- 10-speed

0.334.969/3 silver / silver 002995



**ENHANCED DRIVE ED.10+**

- 1/2" x 11/128"
- longlife chain due to special coating
- with environmentally anti-rust coating
- incl. connecting link
- titanium grey
- 10-speed

0.334.975/0 136 links, self-service package 003995

0.334.997/4 workshop package with 30m (2364 links), incl. 25 connecting links 062995



**RACE R.10**

- 1/2" x 11/128"
- with Race Performance - more drive with less weight
- ultrahard and ultralight
- 116 links, incl. connecting link
- 10-speed

0.334.978/4 silver / silver 004495



**CLASSIC C.11**

- 1/2" x 11/128" (5/64")
- 116 links incl. connecting link
- 11-speed

0.334.946/1 silver / black 002995



**ENHANCED DRIVE ED.11**

- 1/2" x 11/128"
- longlife chain due to special coating
- 136 links, incl. connecting link
- 11-speed

0.334.970/1 silver / silver 003995



**ENHANCED DRIVE ED.11+**

- 1/2" x 11/128"
- longlife chain due to special coating
- with environmentally anti-rust coating
- incl. connecting link
- titanium grey
- 11-speed

0.334.976/8 136 links, self-service package 004495

0.334.998/2 workshop package with 30m (2364 links), incl. 25 connecting links 081095



**RACE R.11**

- 1/2" x 11/128"
- with Race Performance - better performance with less weight
- ultrahard and ultralight
- 116 links, incl. connecting link
- 11-speed

0.334.979/2 silver / silver 004995

Chains 12-speed



**CLASSIC C.12**

- 1/2" x 11/128"
- incl. connecting link
- 126 links
- 12-speed

0.334.947/9 silver / grey 003995



**ENHANCED DRIVE ED.12**

- 1/2" x 11/128"
- longlife chain
- incl. connecting link
- 136 links
- 12-speed

0.334.948/7 silver / silver 004995



**ENHANCED DRIVE ED. 12+**

- 1/2" x 11/128"
- longlife chain with hardened links
- incl. connecting link
- 136 links
- 12-speed

0.334.949/5 self-service package 005995

0.334.949/6 workshop package with 30m (2364 links), incl. 25 connecting links 099900

# Want to determine the number of chain links?

As a dealer it's not always easy to know how many chains you need and how many links you should have. With our chain workshop box you can determine the number of chain links by yourself. The box consists of a large bike chain roll. Depending on your needs, you can cut any length of chain from the roll.

There is a chain link measuring tape that reveals the number of the links, so that you don't have to count them individually. To close the chain piece on the bike, a variety of connecting links are included. The box is an optimal storage container for bike chains, which is space-saving and easy to handle.

2 SETS



**CONNECTOR**

- for easy chain closing
- 2 sets

0.334.934/7 CO.S1, for 1-speed chains, 1/2" x 1/8", black / silver 000395

0.334.935/4 CO.S1N, CO.S8, for 1-speed and 8-speed chains, 1/2" x 3/32", gold / silver 000395

0.334.936/2 CO.S9, for 9-speed chains, 1/2" x 5/64", silver / silver 000395

0.334.953/7 CO.S12, for 12-speed chain, 1/2" x 11/128", silver / silver 000395

2 SETS



**CONNECTOR +**

- for easy chain closing
- 2 sets

0.334.937/0 CO.S10+, for 10-speed chains, 1/2" x 5/64", silver / silver 000795

0.334.938/8 CO.S11+, for 11-speed chains, 1/2" x 5/64", silver / silver 000995

0.334.954/5 CO.S12+, for 12-speed E-bike chains, 1/2" x 11/128", with eco friendly anti-rust coating, titanium-grey 000395



**BRUT**

- aluminium 6061 with nylon guide
- sealed rolls 32-38 teeth
- incl. adapter plate, if no ISCG is available

0.332.959/6 black 007495



**SINGLESPEED**

- for mounting on the derailleur hanger
- for vertical dropout
- suitable for Rohloff

0.734.302/3 single speed 1, simple tensioning capacity, 104g, self-service package 002495

0.734.303/1 single speed 2, increased tensioning capacity, 138g, self-service package 002995

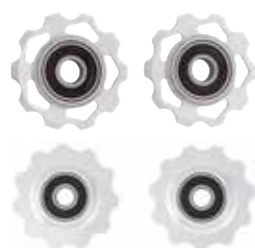

**SCROLL**

- aluminium 6061 T6 incl. bushings
- suitable for all common shifters
- sealed bearings
- splashproof and lightly greased
- pair

0.345.909/6 10 teeth, 5-/8-speed Shimano kompatibel, 9-/10-speed Campagnolo kompatibel 001795

0.345.912/0 11 teeth, 9-/10-speed Shimano kompatibel 001995



**AD-ONE SPEED**

- single speed adapter kit for 8-/9-speed cassette hubs Shimano fitting
- compatible with most common cassette hubs, (also Halo wheels)
- CNC-aluminium spacer ensures a proper chainline
- only for 3/32" chains, not for 5/64" 9-speed derailleur chains

0.345.904/7 incl. 2 sprockets (16 and 18 teeth) 001995



**TFM-340**

- stable, drip-free housing
- brushes clean the chain from all sides
- very easy to use

0.334.920/6 plastic 001995



**NEOPREN**

- made of durable neoprene
- protects against scratches from the chain
- with easy velcro installation
- dirt-resistant and machine washable

0.334.915/6 for standard frames, 260 x 80 x 100mm 000695

0.334.916/4 for oversize frames, 260 x 90 x 110mm 000695



**FULL HD**

- prevents from paint scratching over chain and cable
- High Modulus PU
- self-adhesive and suitable for all frame diameters
- consisting of: 1x chain guard 31 x 230mm, 5x frame protection round Ø 30mm, 5x frame protection oval 20 x 50mm, square 88 x 92mm

0.334.922/2 transparent 000995



**HD**

- prevents paint scratching over chain and cable
- High Modulus PU
- self-adhesive and suitable for all frame diameters
- consisting of: 2x chain guards 31 x 230mm

0.334.921/4 transparent 000795



**FULL SCREEN**

- prevents paint scratching over chain and cable
- 3M material
- self-adhesive and suitable for all frame diameters
- consisting of: 1x chain guard 260mm, 4x frame guard round Ø 27mm, 4x frame guard round Ø 20mm

0.334.917/2 transparent 000795



**ZEN**

- protects against paint scratches
- silicone
- self-adhesive
- 260 x 27 x 20mm

0.334.926/3 black 000695





CLICK  
IN/OUT

Pedals with this icon  
are compatible with  
the Click system.



KIDS

Especially for children.  
Parts and accessories that  
feature design, size and  
and color especially for the  
youngest cyclists.



## PEDALS

### Your best finish

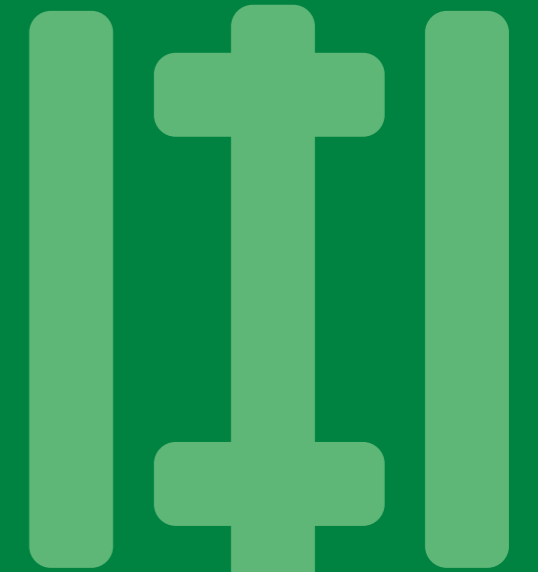

A reliable pedal is the be-all and end-all for your safety when cycling. So that every kick fits, we at CONTEC have a wide variety of system, platform and hybrid pedals, as well as classic pedals for everyday use. So you can choose a set of pedals that is best suited to your individual needs.

**System pedals** or click pedals are often used by road cyclists. With the right shoes and cleats you can connect your feet to the pedal. This creates an efficient power transmission of your entire leg muscles.

**Platform pedals** refer to classic MTB pedals. They are wider and longer than classic pedals and also have pins. These also provide better grip in muddy conditions.

**Hybrid pedals** form a combination of system and platform pedals, which can be used differently on two sides. This is particularly practical if you are not quite sure whether you always want to use a click pedal.

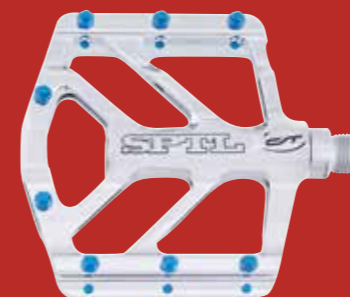

SPATULA GLITZ P.226



TWOFACE P.226



**SPATULA GLITZ**

- CNC-machined aluminium housing, glossy coating
- CNC-machined CrMo axles
- sealed industrial bearings
- replaceable pins (R-pins)
- 108 x 106mm
- 294g

0.336.994/9 icy 012995



**SPATULA II**

- CNC-milled extreme flat aluminium housing
- CNC-machined CrMo axle
- sealed industrial bearings
- replaceable pins (R-pins)
- 108 x 106mm
- 340g

0.336.968/3 black 012995



**TWOFACE**

- CNC-machined aluminium housing
- CNC-machined CrMo axle
- sealed industrial bearing
- flat profile
- replaceable pins
- 120 x 108mm
- 370g

0.336.860/2 matt black, sandblasted 007995



**SWAGGER**

- CNC-machined aluminium housing
- CNC-machined CrMo axle
- sealed industrial bearing
- flat profile
- replaceable pins
- 112 x 102mm
- 304g

0.336.863/6 matt black, sandblasted 007995



**VICE**

- CNC-machined aluminium, extruded, anodized
- CNC-machined CrMo axle
- sealed LSL bearings: self-lubricating and maintenance-free bush bearings
- flat profile
- replaceable pins
- 106 x 96mm
- 406g

0.336.905/5 black 007995



**SPIKE.22**

- CNC-machined aluminium housing
- CrMo axle 9/16"
- sealed industrial bearings
- 2x 22 replaceable CrMo pins for max. grip
- 110 x 100mm
- 400g

0.336.813/1 black 007995

0.336.814/9 silver 007995



**BLACK22**

- one-piece aluminium housing
- CNC-machined CrMo axle
- sealed industrial bearings
- removable reflectors
- replaceable pins (R-pins)
- 111 x 108mm
- 420g

0.336.997/2 black 005495

NEW



**TENDERIZER**

- one-piece nylon housing
- CrMo axle
- industrial sealed bearings
- SL bushing
- 113 x 114mm
- MTB replaceable pins (R-Pins)
- 113 x 114mm
- 183g

0.336.938/7 black 003995



**2BLACK**

- one-piece aluminium housing
- CrMo axle
- replaceable pins (R-pins)
- removable reflectors
- ball bearings
- 109 x 100mm
- 420g

0.336.938/6 black 003495



**2WHITE**

- one-piece aluminium housing
- CrMo axle
- replaceable pins (R-pins)
- removable reflectors
- ball bearings
- 109 x 100mm
- 420g

0.336.967/5 white 003495



**SPURT**

- CNC-machined aluminium housing
- CrMo axle
- sealed industrial bearings
- replaceable pins
- 82 x 100mm
- 248g

0.336.890/9 silver 008995

0.336.867/7 black 008995

**RAPID**

- CNC-machined aluminium, extruded, anodized
- CrMo axle
- sealed bearings, bush bearings
- flat profile
- replaceable pins
- 100 x 100mm
- 243g

0.336.915/4 black 007495

**PITCHBLACK**

- aluminium housing
- CrMo axle
- sealed industrial housing
- replaceable pins
- 86 x 100mm
- 320g

0.336.862/8 matt black, sandblasted 006995

**RAPID2**

- minimalist aluminium housing
- CrMo axle
- sealed industrial bearings
- 87 x 99mm
- 230g

0.336.889/1 black 006495

**BLADE**

- aluminium housing
- CrMo axle
- sealed industrial bearing
- replaceable pins
- 100 x 70mm
- 236g

0.336.861/0 black 005995

**CPI-070**

- aluminium housing
- CrMo axle
- sealed industrial bearings
- 108 x 78mm
- 280g

0.336.926/1 black 005995

**TRAIL2**

- one-piece CNC-machined aluminium housing
- CrMo axle
- 105 x 70mm
- 281g

0.336.969/1 black 005995

**TRAIL**

- aluminium housing
- CrMo axle
- sealed industrial bearings
- 100 x 60mm
- 238g

0.336.963/4 black 004995

**RAMP**

- nylon housing
- CNC-machined CrMo axle
- large surface
- sealed industrial bearings
- 105 x 104mm
- 257g

0.336.958/4 black 003495

**TWIRL**

- aluminium housing
- boron steel axle
- ball bearings
- 100 x 78mm
- 368g

0.336.910/5 black 001695



**A-GRIND**

- polished aluminium housing
- boron steel axle
- ball bearing
- 116 x 103mm
- 387g

0.336.052/6 black

001995

**GRIND**

- nylon housing
- boron steel axle
- ball bearings
- 111 x 105mm
- 346g

0.336.917/0 black

001295

**PIVOT**

- aluminium housing
- CrMo axle
- sealed industrial bearings
- 100 x 67mm
- 266g

0.336.953/5 black / silver

002595

**BLACKTOP**

- CNC-machined aluminium housing
- cone bearings
- 102 x 64mm
- approx. 268g

0.336.809/9 black / silver

002495

**SPINNER**

- aluminium housing
- CrMo axle 9/16"
- polished ball bearing
- 98 x 64mm
- approx. 240g

0.336.053/4 silver / black

002195

**FLOW**

- plastic housing / steel cage
- boron steel axle
- cone mounts
- 95 x 60mm
- 382g

0.336.943/6 black

001495

# Click, click, luck



## TALON

- at both sides
- binding compatible with Shimano SPD
- double-sided CrMo binding with adjustable release hardness and + 12° EasyIO step-in aid
- the open design does not give dirt and mud deposits much of a chance to build up
- sealed compact axle bearing unit
- incl. cleats
- 96 x 75mm
- 414g

0.336.865/1 matt black / silver 009995



## BUFFET

- both sides
- Shimano SPD compatible connection
- both sides CrMo connection with adjustable release tension and + 15° EasyIO entry aid
- the open design gives mud and sludge deposits little chance
- sealed compact axle bearing unit
- incl. cleats
- 105 x 103g
- 568g

0.336.812/3 aluminium cage, impala grey 009995



## P-XCX

- both sides
- aluminium body
- Shimano SPD compatible connection
- CrMo connection with adjustable release
- the open design gives mud and sludge deposits little chance
- incl. cleats
- CrMo axle
- industrial sealed bearings
- 80 x 60mm
- 350g

0.336.993/1 black 006995



## SPRINT

- at one side
- aluminium housing
- binding compatible with Shimano SPD
- easy click in and out
- adjustable release force
- incl. cleats
- CrMo axle
- industrial sealed bearing
- 105 x 66mm
- 366g

0.336.864/4 black / silver 005995

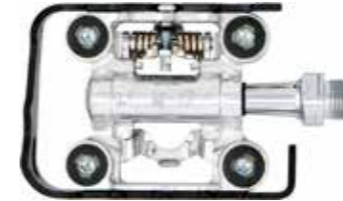

## DUAL SPORT

- one side
- aluminium housing
- Shimano SPD compatible connection
- easy click-in/-out
- adjustable release force
- incl. cleats and 1 set distance rubbers
- CrMo axle
- sealed industrial bearings
- 101 x 66mm
- 350g

0.336.965/9 black / silver 005495

## City / Trekking Pedals

NEW



## QUICK.ACE

- flat, one-part aluminium housing
- CrMo steel axle
- sealed industrial bearings
- sandpaper anti-slip
- with removable reflector
- 98 x 78mm
- 316g

0.336.866/9 glossy black 005995



## QUICK.STAR

- flat, one-piece plastic housing with grip profile
- CrMo steel axle
- industrial sealed bearings
- sandpaper anti-slip surface
- 110 x 83mm
- 410g

0.336.867/0 black 004995

**QUICK DELUXE +**

- nylon housing
- CrMo steel axle
- sealed industrial bearings
- sandpaper anti-slip
- 111 x 87mm
- 340g

0.336.886/7 black

003495

**QUICK +**

- nylon housing
- boron steel axle
- ball bearings
- sandpaper anti-slip
- 111 x 87mm
- 353g

0.336.885/9 black

001995

**QUICK STEP**

- plastic housing
- boron steel axle
- DU bearing
- anti-slip surface with sandpaper
- 80 x 100mm
- 310g

0.336.859/4 black

001195

**QUICK CLASSIC**

- nylon housing
- boron steel axle
- ball bearings
- rubber anti-slip
- 107 x 100mm
- 280g

0.336.884/2 black / grey

000995

**QUICK CORE**

- nylon housing
- boron steel axle
- ball bearings
- 100 x 80mm
- 277g

0.336.883/4 black

000995

**1 BOOT**

- aluminium housing / plastic cage
- CrMo axle
- sealed industrial bearings
- anti-slip surface
- 100 x 80mm
- 260g

0.336.920/4 silver / black

003195

**1 TRIP**

- aluminium housing / plastic cage
- CrMo axle
- sealed industrial bearings
- anti-slip surface
- 103 x 80mm
- 270g

0.336.957/6 silver / grey

003295

**VERGE**

- aluminium housing
- CrMo axle
- sealed industrial bearings
- anti-slip surface
- 103 x 70mm
- 304g

0.336.952/7 black / silver

002595



**BOOT**

- aluminium housing / plastic cage
- CrMo axle
- ball bearings
- anti-slip surface
- 100 x 80mm
- 310g

0.336.921/2 silver / black

001995

**CRUISER**

- aluminium housing
- boron steel axle
- ball bearing
- anti-slip surface
- 108 x 69mm
- 420g

0.336.044/3 silver

001795

**TRIP**

- plastic housing
- CrMo axle
- ball bearings
- anti-slip surface
- 103 x 80mm
- 244g

0.336.949/3 black / grey

001095

**QUICK CORE**

- plastic housing
- boron steel axle
- ball bearing
- 111 x 80mm
- 328g

0.336.858/6 black / grey

000995

**CP-024**

- plastic housing
- boron steel axle
- cone mounts
- anti-slip surface
- 110 x 84mm
- 350g

0.336.947/7 black / grey

000995

**SHEEP**

- plastic housing
- boron steel axle
- cone mounts
- 350g

0.336.942/8 black

000995

**CP-021**

- plastic housing
- boron steel axle
- ball bearings
- 100 x 80mm
- 230g

0.336.925/3 black

000995

**CP-044**

- steel housing
- plastic frame
- polished ball bearings
- approx. 378g

0.336.815/6 black / silver

001095

**FOLDER**

- plastic housing / folding mechanism
- CrMo axle
- ball bearings
- 105 x 73mm
- 328g

0.336.912/1 black

001795

## Pedals Quick release

**1TRIP QR**

- aluminium housing / plastic cage
- with QRDII QR fastener for simple disassembly of the pedals
- incl. storage bag for demounted pedals
- CrMo axle
- sealed industrial bearings
- ant-slip surface
- 103 x 80mm
- 315g

0.336.903/0 silver / black

006995



KIDS

**HAPPY KID DLX**

- nylon housing
- boron steel axle
- DU bearing
- anti-slip surface with sandpaper
- with reflector
- 97 x 86mm
- 276g

0.336.857/8 black

001595



KIDS

**HAPPY KID**

- plastic housing
- boron steel axle
- ball bearings
- 93 x 87mm
- 300g

0.336.894/1 black

000895



KIDS

**PLAYER**

- plastic housing
- boron steel axle
- cone mounts
- 95 x 64mm
- 230g

0.336.940/2 black

000895

# Quick release pedals

More space & more theft protection: Some of our pedals are equipped with a quick release function, with which you can attach and detach your pedals in a flash. This not only provides more parking space for

your bike, preventing the pedals from getting caught, but also protects it from thieves. Because without pedals, the thief does not get far.

# Good combination

With cleats you create the connection between your system pedal and your road bike or MTB shoes. When these need to be replaced after a certain period of use, it is often tedious to find the previously set position of the cleats again. This is exactly where the puzzle system comes into play: Our puzzle cleats are divisible, so

they can be only partially dismantled and compared with the respective new counterpart when replacing. So your shoe always remains exactly in your desired position on the pedal.



### PUZZLE SPD SL

- suitable for Shimano SPD-SL-System
- with 6° freedom of movement

0.336.850/3 black / yellow 001495



### PUZZLE KEO

- suitable for Look Keo system
- with 9° freedom of movement

0.336.851/1 black / red 001495



### PUZZLE PROTECT

- facilitates walking
- reduces wear
- non-slip
- easy to install

0.336.854/5 suitable for Shimano SPD SL 000995

0.336.855/2 suitable for Look Keo 000995



### CLIP SPD

- suitable for Shimano SPD system
- with 14° freedom of movement and multiple release

0.336.852/9 silver 001495



### CLIP LOOK

- suitable for LOOK system (not for KEO Carbon)
- with 9° freedom of movement

0.336.853/7 red 001495

## Accessories Pedals



### SPORT

- plastic
- 71g / pair

0.336.971/7 black 000795



### TRACK

- stainless steel
- 80g / pair

0.336.978/2 silver 001495



**NYLON STRAP**

- nylon
- 25g / pair

0.336.970/9 black	000795
-------------------	--------

**LEATHER STRAP**

- leather
- 44g / pair
- 13 x 450mm

0.336.975/8 black	001295
-------------------	--------

0.336.976/6 brown	001295
-------------------	--------

**P-REFLEX**

- for MTB / ATB pedals
- screw mounting

0.336.972/5 set with 4 pieces	000795
-------------------------------	--------

**R-PINS SELECT**

- aluminium pedal pins
- set with 20 pieces
- suitable for pedal 2Black, 2White, Black22, White22 and Spatula II
- incl. key

0.336.979/0 rocket silver	001295
---------------------------	--------

0.336.980/8 limousine black	001295
-----------------------------	--------

0.336.981/6 blue steel	001295
------------------------	--------

0.336.982/4 riot red	001295
----------------------	--------

0.336.983/2 heart of gold	001295
---------------------------	--------

0.336.984/0 ultra violet	001295
--------------------------	--------

0.336.985/7 guerilla green	001295
----------------------------	--------

0.336.986/5 odd orange	001295
------------------------	--------

**R-PINS+**

- steel pedal pins
- set with 20 pieces
- suitable for pedal 2Black, 2White, Black22, White22, Spatula and Spatula II
- incl. key

0.336.892/5 silver	001295
--------------------	--------

**SPIKE.22**

- steel
- set with 22 pieces
- suitable for pedal Spike.22

0.336.004/7 silver	000495
--------------------	--------



E-READY

Suitable for your e-bike,  
suitable for the respective  
voltage.



## CASSETTES

### Smooth shifting

So that your derailleur runs smoothly, the efficiency of your cassette is important. Our new cassettes for bikes and e-bikes are made of particularly tensile tensile steel, which are lighter and more durable than conventional models made of aluminum. Therefore, due to longer maintenance intervals, you do not have to replace the wear parts as often.

Our models have different tooth numbers and have special climbing aids for the chain, which make each of your gear changes faster and smoother. The Grad. HT variant has a particularly high torque for e-bike middle motors. For e-bikes with a Shimano Linkglide technology, we have developed the special variant Grad.LG.



GRAD.HT P.246



GRAD.LG P.247



# Effortlessly

NEW



E-READY

## GRAD.HT

- 8-speed
- aluminium lockring
- high tensile steel sprocket
- Shimano HG compatible
- reinforced for e-bike

0.337.001/8	11-13-15-18-21-24-28-32	004995
	teeth, 306g	
0.337.001/9	11-13-16-20-24-28-32-36	004995
	teeth, 388g	
0.337.002/0	11-13-16-20-24-28-34-42	004995
	teeth, 469g	

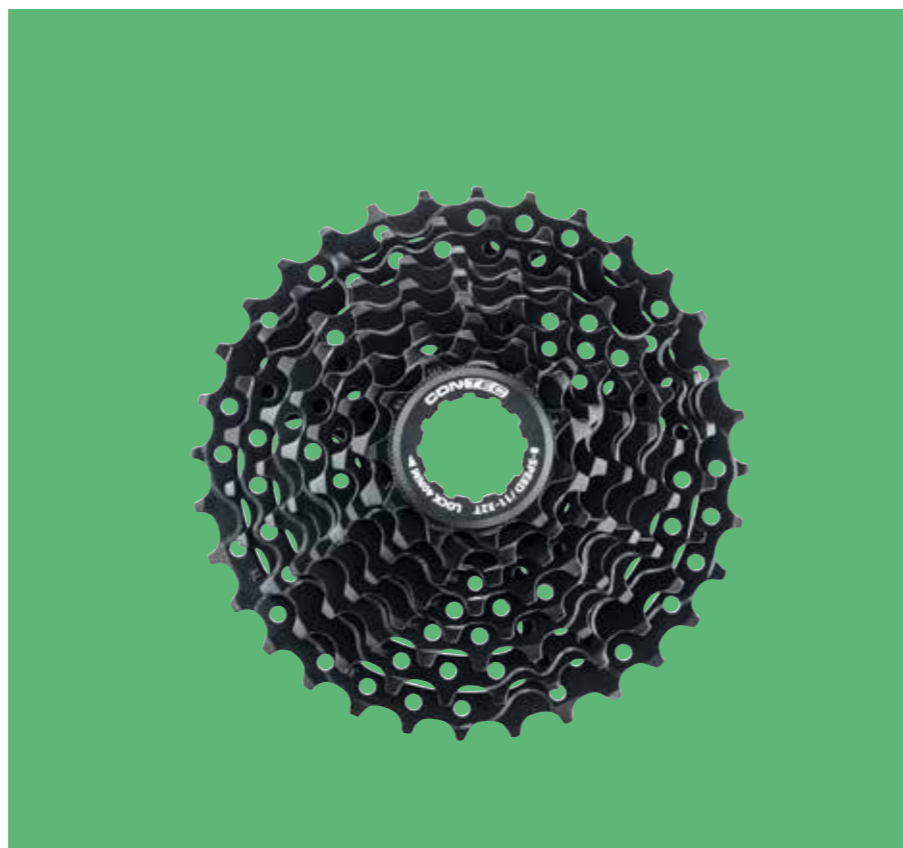

NEW



## GRAD

- 8-speed
- aluminium lockring
- aluminium large sprocket
- all other made of high tensile steel
- Shimano HG compatible

0.337.004/2	11-13-15-17-19-21-24-28	teeth, silver, 252g	002995
0.337.002/9	11-13-15-18-21-24-28-32	teeth, silver / black, 306g	002995
0.337.003/0	11-13-16-20-24-28-32-36	teeth, silver / black, 385g	002995

NEW



E-READY



## GRAD.HT

- 9-speed
- aluminium lockring
- high tensile steel sprocket
- Shimano HG compatible
- reinforced for e-bike

0.337.002/1	11-13-15-17-19-21-24-28-32	teeth, 332g	004995
0.337.002/2	11-13-15-18-21-24-28-32-36	teeth, 393g	004995

NEW



E-READY



## GRAD.LG

- 9-speed
- only for SHIMANO LINKGLIDE shifting e.g. Cues
- compatible with 11-speed LINKGLIDE chains
- aluminium lockring
- high tensile steel sprocket
- for e-bikes with high torque
- can be shifted under load, reduces annoying noises and shift jerking
- 3x more durable than conventional cassettes

0.337.004/8	11-13-16-20-24-28-32-36-42	teeth, 532g	004995
-------------	----------------------------	-------------	--------

NEW



## GRAD

- 9-speed
- aluminium lockring
- aluminium large sprocket
- all other made of high tensile steel
- Shimano HG compatible

0.337.004/3	11-13-15-17-19-21-23-25-28	teeth, silver, 284g	002995
0.337.003/1	11-13-15-17-19-21-24-28-32	teeth, silver / black, 328g	002995
0.337.003/2	11-13-15-18-21-24-28-32-36	teeth, silver / black, 398g	002995

NEW



E-READY



## GRAD.HT

- 10-speed
- aluminium lockring
- high tensile steel sprocket
- Shimano HG compatible
- reinforced for e-bike

0.337.002/3	11-13-15-17-19-21-24-28-32-36	teeth, 429g	005995
0.337.002/4	11-13-15-18-21-24-28-32-36-42	teeth, 531g	006995
0.337.002/5	11-13-16-20-24-28-32-36-42-50	teeth, 707g	007995

NEW



E-READY



## GRAD.LG

- 10-speed
- only for SHIMANO LINKGLIDE shifting e.g. Cues
- compatible with 11-speed LINKGLIDE chains
- aluminium lockring
- high tensile steel sprocket
- for e-bikes with high torque
- can be shifted under load, reduces annoying noises and shift jerking
- 3x more durable than conventional cassettes

0.337.004/9	11-13-15-18-21-24-28-32-36-42	teeth, 561g	005995
-------------	-------------------------------	-------------	--------



NEW



**GRAD**

- 10-speed
- aluminium lockring
- aluminium large sprocket
- all other made of high tensile steel
- Shimano HG compatible

0.337.004/4	11-12-13-15-17-19-21-23-25-28 teeth, silver, 293g	003495
0.337.003/3	11-13-15-17-19-21-24-28-32-36 teeth, silver / black, 422g	003495
0.337.003/4	11-13-15-18-21-24-28-32-36-42 teeth, with aluminium double spider, silver / black, 436g	007995
0.337.003/5	11-13-15-18-21-24-28-34-40-46 teeth, with aluminium double spider, silver / black, 538g	007995

NEW



**GRAD.HT**

- 11-speed
- aluminium lockring
- high tensile steel sprocket
- aluminium single spider
- Shimano HG compatible
- reinforced for e-bike

0.337.002/6	11-13-15-17-19-21-24-28-32-36-42 teeth, 570g	007995
0.337.002/7	11-13-15-18-21-24-28-32-36-42-50 teeth, 748g	008995

NEW



**GRAD.LG**

- 11-speed
- only for SHIMANO LINKGLIDE shifting e.g. Cues
- compatible with 11-speed LINKGLIDE chains
- aluminium lockring
- high tensile steel sprocket
- for e-bikes with high torque
- can be shifted under load, reduces annoying noises and shift jerking
- 3x more durable than conventional cassettes

0.337.005/4	11-13-15-18-21-24-28-32-36-42-50 teeth, 782g	009995
-------------	--	--------

NEW



**GRAD**

- 11-speed
- aluminium lockring
- aluminium large sprocket
- all other made of high tensile steel
- Shimano HG compatible

0.337.004/5	11-12-13-14-15-17-19-21-23-25-28 teeth, 307g	005995
0.337.004/6	11-12-13-15-17-19-21-23-25-28-32 teeth, 363g	005995
0.337.004/7	11-12-13-15-17-19-21-23-25-28-34 teeth, 377g	005995
0.337.003/6	11-13-15-17-19-21-24-28-32-36-40 teeth, with aluminium double spider, 444g	007995
0.337.003/7	11-13-15-17-19-21-24-28-32-36-42 teeth, with aluminium double spider, 454g	008495
0.337.003/8	11-13-15-18-21-24-28-32-36-40-46 teeth, with aluminium double spider, 546g	008995
0.337.003/9	11-13-15-18-21-24-28-32-36-42-50 teeth, with aluminium double spider, 572g	009995

NEW



**GRAD.HT**

- 12-speed
- aluminium lockring
- high tensile steel sprocket
- aluminium single spider
- Shimano HG compatible
- reinforced for e-bike

0.337.002/8	11-13-15-17-19-21-24-28-32-36-42-50 teeth, 757g	011995
-------------	---	--------

NEW



**GRAD**

- 12-speed
- aluminium lockring
- high tensile steel sprocket
- aluminium double spider
- Shimano HG compatible
- reinforced for e-bike

0.337.004/0	11-13-15-17-19-21-24-28-32-36-40-46 teeth, 551g	011995
0.337.004/1	11-13-15-17-19-21-24-28-32-36-42-50 teeth, 580g	011995







WATER PROOF

Bags with the Waterproof Icon feature waterproof materials that prevent items inside from getting wet.



VOLUME

The volume icon indicates the size of the possible packing volume of this bag in liters.



CLICK IN/OUT

Suitable for the specified mounting system, for quick attachment and detachment of bags and accessories from system carriers, handlebar mounts and adapters.



RIM

Suitable for wheels in the specified size.



REFLECTION

This icon indicates attached reflective stripes for better visibility in road traffic.



# LUGGAGE



## Your companion on every tour

With CONTEC each of your treasures is safe – whether small or large. We offer a variety of different bike bags for every need. Our range includes suitable storage options for the rear carrier, waterproof backpacks as well as clever bags for handlebars and frames. So

what are you waiting for? Start your next bikepacking adventure, your next bike tour or your daily commute with the good feeling that you don't have to leave anything you might need at home.



VIA.BACK MIK P.260



MILE GRINDER COMMUTE 25 P.266

# Upgrade with our luggage carriers

Simpler, more versatile and chic: Our new CRICKER aluminum carriers combine high load capacity with flexible mounting. The CRICKER is suitable for mounting on the seatpost of your bike and has a maximum load of 10 kilograms. The CRICKER FIX is

attached as usual to the rear triangle of your bike and carries a load of up to 25 kilograms. Both carriers are equipped with the MIK system and are suitable for bikes with disc and rim brakes.

NEW



## CRICKER

- incl. spring clamp
- aluminium
- seatpost attachment (Ø 25-31,8mm)
- incl. MIK system
- max. load: 10kg
- 808g

0.338.971/0 matt black

005995

NEW



## CRICKER FIX

- incl. spring clamp
- aluminium
- elegant cover for the front attachment
- suitable for bikes with or without disc brake
- incl. MIK system
- max. load: 25kg
- 930g

0.338.970/9 matt black

004995



## CARGO PLUS

- lockable carrier box
- removable by a 4-point adapter with a push-button
- suitable for all common carriers
- with additional hinged closures
- capacity: 13l, dimensions (LxWxH): 36,5 x 25,5 x 17,5cm

0.339.019/2 black

005995



## CARGO

- lockable carrier box
- suitable for all common carriers
- with additional hinged closures
- capacity: 13l, dimensions (LxWxH): 36,5 x 25,5 x 17,5cm

0.339.013/5 black

004995



## TRUNK SPACE

- lockable carrier box
- suitable for all common carriers
- with additional hinged closures
- capacity: 15,5l, dimensions (LxWxH): 43,2 x 26,2 x 22,5cm

0.339.012/7 black

003995



## 4-POINT ADAPTER

- suitable for Cargo and Cargo Plus

0.338.925/1 black

002495



# Your luggage always in view

A stylistic must for every classic city bike: front baskets! The CONTEC Espresso front baskets are available for both fixed and flexible mounting. That's possible thanks to the Espresso KF model, which is supplied

with an adapter for KLICKfix and BasEasy mount. With just one action, the front basket turns into a basket you can carry. The soft grip handle ensures even more comfort.



## ESPRESSO

- fixed attachment
- steel
- reflective logo
- height adjustable
- dimensions (LxWxH): 25 x 34 x 28cm

0.738.189/0 black

002995



## ESPRESSO KF

- incl. adapter plate for KLICKfix and BasEasy holders
- steel, handle with soft grip
- reflective logo
- height adjustable
- dimensions (LxWxH): 25 x 34 x 28cm

0.738.190/8 black

003295

# Triple possible

Three carrier systems and one thing in common: compatibility with the baskets from CONTEC! With us you will quickly find the right basket for your bike. A quick look at your carrier, tells you with which system you are traveling – MIK, Racktime or AtranVelo (AVS). Then just choose the right one out of our basket

assortment. In case of doubt, you are safe with our multi-models, which can be adapted to any of the systems with the help of the respective adapter plate. Or you can take a look at our How-To on the different luggage carrier systems on our website!



## LUNGO MULTI

- with universal hole pattern on the base for easy attachment of MIK, Racktime or AVS adapter plate (adapters are not incl.)
- steel, handle with soft grip
- reflective logo
- compatible with CONTEC "FlavourBelt"
- stand feet
- dimensions (LxWxH): 45 x 31 x 22cm

0.738.187/4 black

002995



## FREDO

- hooks attachment in combination with the spring clamp
- steel, handle with soft grip
- reflective logo
- compatible with CONTEC "FlavourBelt"
- dimensions (LxWxH): 31 x 35 x 18cm

0.738.188/2 black

001795



**MOCCA**

- for fixed assembly
- incl. mounting material
- steel
- reflective logo
- compatible with CONTEC "FlavourBelt"
- dimensions (LxWxH): 45 x 31 x 22cm

0.738.182/5 black

003295

**MOCCA MULTI**

- with universal hole pattern on the basket base for easy attachment of MIK, Racktime or AVS adapter plates (adapters are not incl.)
- steel, handle with soft grip
- reflective logo
- compatible with CONTEC "FlavourBelt"
- stand feet
- dimensions (LxWxH): 45 x 31 x 22cm

0.738.184/1 black

004495

**MOCCA MIK**

- incl. MIK adapter plate
- steel, handle with soft grip
- reflective logo
- compatible with CONTEC "FlavourBelt"
- stand feet
- dimensions (LxWxH): 45 x 31 x 22cm

0.738.185/8 black

006495

**MOCCA RT**

- incl. Racktime adapter plate
- steel, handle with soft grip
- reflective logo
- compatible with CONTEC "FlavourBelt"
- stand feet
- dimensions (LxWxH): 45 x 31 x 22cm

0.738.186/6 black

006495

**FLAVOURBELT**

- for optimal securing of luggage in CONTEC basket
- usable as carrying strap
- can optionally be attached crosswise or lengthways
- double secured with button and Velcro
- incl. CONTEC reflective logo
- dimensions (LxW): 53 X 4CM

0.738.191/6 black

001295

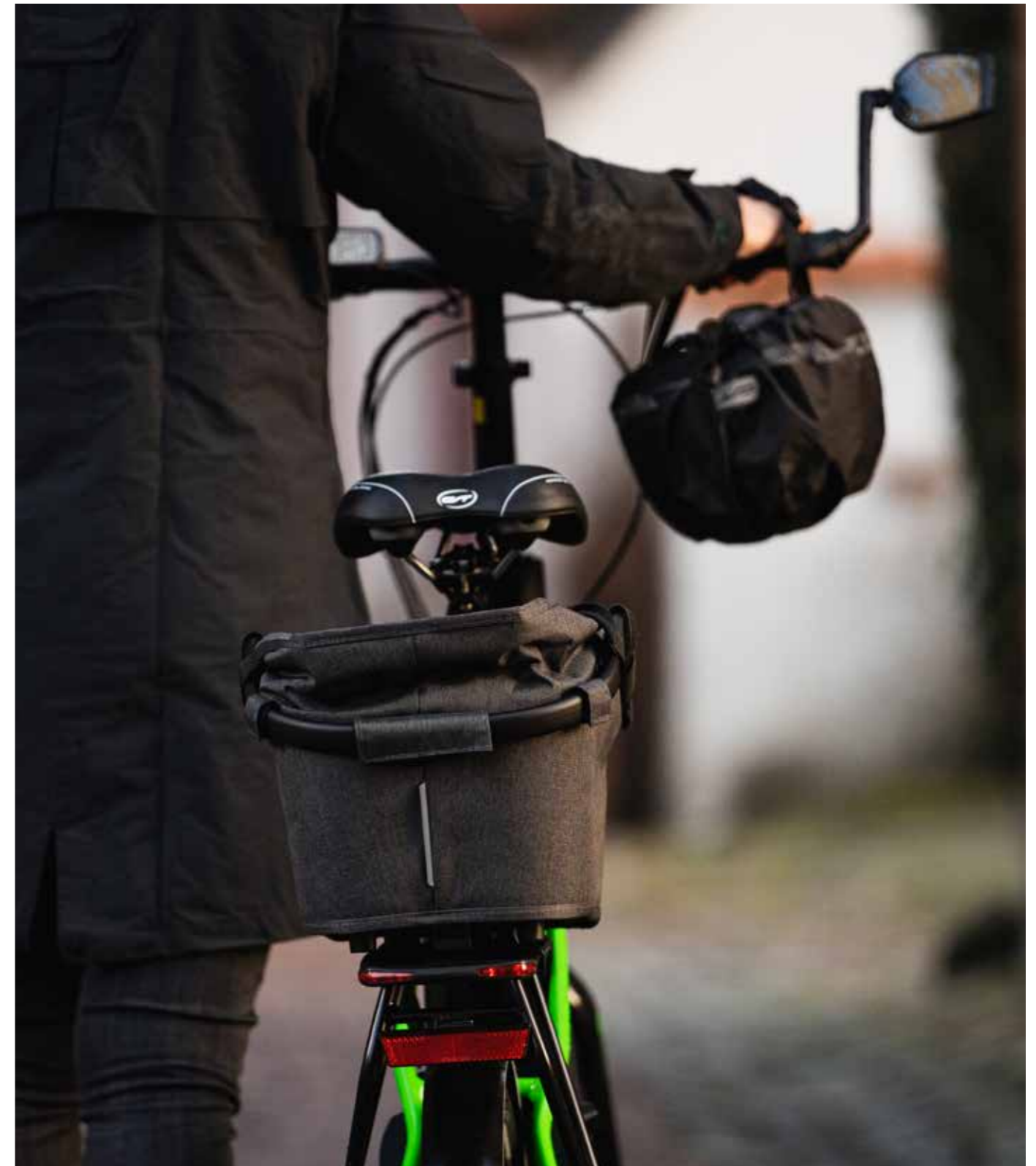
CLICK  
IN/OUTCLICK  
IN/OUT

# On all paths with Via

"Via" means in "way" in Latin and was the inspiration for our versatile bike bag collection. Here you will find a wide selection of different bike bags for your individual use. From the practical handlebar bag to the popular double and single carrier bags for rack

carrier to our stylish shoulder bag. Highlights include commuter and travel-friendly features, such as water repellent material, reflective elements, an integrated rain cover and a clever luggage division.

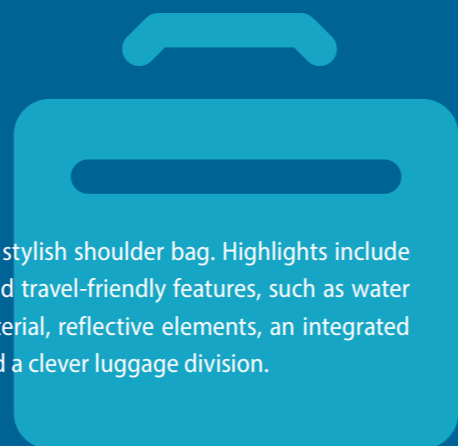

## VIA.FRONT

- stylish handlebar bag
- made of water repellent polyester
- with transparent compartment for smartphone and opening for the charging cable in the lid
- incl. adjustable shoulder belt and pre-mounted KlickFix mounting plate
- capacity: 7,5l, dimensions: (LxWxH) 23,5 x 14 x 23cm

0.739.929/8 dim black	007995
-----------------------	--------



## VIA.PHONE

- stylish smartphone bag
- made of water repellent polyester
- with transparent compartment to operate the smartphone
- with practical inner compartment
- incl. Rixen & Kaul Quad adapter
- capacity: 0,6l, dimensions (LxWxH): 18 x 6,5 x 8cm

0.739.930/6 dim black	004995
-----------------------	--------

0.739.931/4 rusty red	004995
-----------------------	--------

0.739.932/2 desert sand	004995
-------------------------	--------



## VIA.OFFICE

- stylish shoulder bag
- made of water repellent polyester
- with large main compartment suitable for 15,6" notebooks and extra inner compartment
- incl. adjustable shoulder belt and bike hooks in zippered compartment
- with reflective elements
- capacity: 18l, dimensions (LxWxH): 39 x 16 x 30cm

0.739.922/3 dim black	005995
-----------------------	--------



## VIA.TOUR

- stylish single bag
- made of water repellent polyester
- with large main and extra inner compartment
- zippered compartment in the lid
- incl. adjustable shoulder belt and bike hooks in zippered compartment
- with reflective elements
- capacity: 16l, dimensions (LxWxH): 35 x 15 x 35cm

0.739.913/2 dim black	005995
-----------------------	--------

0.739.914/0 rusty red	005995
-----------------------	--------

0.739.915/7 desert sand	005995
-------------------------	--------



## VIA.TOUR DOUBLE RT

- stylish twin bag
- made of water repellent polyester
- with large main and extra inner compartment
- zippered compartment in the lid
- incl. reflective elements and pre-mounted Racktime Snap-it adapter
- capacity: 32l (2x 16l), dimensions (LxWxH): 2x 35 x 15 x 35cm

0.739.916/5 dim black	010995
-----------------------	--------

0.739.918/1 rusty red	010995
-----------------------	--------

0.739.920/7 desert sand	010995
-------------------------	--------



## VIA.TOUR DOUBLE MIK

- stylish twin bag
- made of water repellent polyester
- with large main compartment and extra inner compartment
- zippered compartment in the lid
- incl. reflective elements and pre-mounted MIK adapter
- capacity: 32l (2x 16l), dimensions (LxWxH): 2x 35 x 15 x 35cm

0.739.917/3 dim black	010995
-----------------------	--------

0.739.919/9 rusty red	010995
-----------------------	--------

0.739.921/5 desert sand	010995
-------------------------	--------





**VIA.BACK RT**

- stylish carrier bag
- made of water repellent polyester
- with a large main compartment that can be extended upwards and two fold-out side pockets
- rear pocket for drinking bottles and 3 other inner compartments
- incl. reflective elements and pre-mounted Racktime Snap-it adapter
- capacity: 32l, dimensions (LxWxH): 35 x 20 x 27cm

0.739.923/1 dim black	010995
0.739.925/6 rusty red	010995
0.739.927/2 desert sand	010995



**VIA.BACK MIK**

- stylish carrier bag
- made of water repellent polyester
- with a large main compartment that can be extended upwards and two fold-out side pockets
- rear pocket for water bottles and 3 additional inner compartments
- incl. reflective elements and pre-mounted MIK adapter
- capacity: 32l, dimensions (LxWxH): 35 x 20 x 27cm

0.739.924/9 dim black	010995
0.739.926/4 rusty red	010995
0.739.928/0 desert sand	010995



**VIA.BACK AVS**

- carrier bag
- water repellent polyester
- with large expandable main compartment and two foldout side pockets
- back pocket for water bottles and 3 other inner compartments
- with integrated rain cover
- incl. reflective elements and pre-mounted AVS adapter
- capacity: 32l, dimensions (LxHxW): 35 x 27 x 20cm

0.739.935/5 dim black	010995
-----------------------	--------



**VIA.BATTERY**

- battery bag
- suitable for removed E-Bike batteries during transport
- with inner cushion to protect against damages
- dim black

0.739.933/0 dimensions (LxWxH): 34 x 10 x 9cm, suitable for frame batteries	002995
0.739.934/8 dimensions (LxWxH): 40 x 16 x 8cm, suitable for carrier batteries	002995



**VIA.POCKET**

- style saddle bag
- water repellent polyester
- with practic zippered compartment
- with handle for better transport
- incl. pre-mounted KLICKFix saddle adapter
- capacity: 0,9l, dimensions (LxWxH): 17 x 10 x 9cm

0.739.936/3 dim black	003495
-----------------------	--------



# LIM: Timeless luggage solutions

The CONTEC urban collection gives you a clear head in the question of how to store your stuff smart on your bike. Our LIM bags and baskets with a timeless design will attract and impress you in the long term with their clever storage space and versatile features. The LIM Trunkbar, for example, can be mounted either

on your carrier or handlebar. In addition our LIM Single impresses with its double function on the bike and as a carrying bag. No matter which luggage solution you choose from our LIM collection: you can expect water repellent materials, various mounting options and plenty of volume.



## LIM TRUNKBAR

- urban handlebar / carrier bag
- made of water repellent polyester
- incl. attachment for the carrier and adapter for KlickFix and BasEasy system
- incl. adjustable and removable shoulder belt
- with reflective applications
- capacity: 5l, dimensions (LxWxH): 32 x 30 x 14cm

0.839.876/0 olive green 005495

0.839.877/8 ashy grey 005495



## LIM SINGLE

- urban single bag
- made of water repellent polyester
- incl. adjustable and removable shoulder belt and bike hooks
- with reflective applications
- capacity: 17l, dimensions (LxWxH): 49 x 30 x 18cm

0.839.870/3 olive green 006495

0.839.871/1 ashy grey 006495



## LIM DOUBLE

- urban twin bag
- made of water repellent polyester
- incl. universal bar for fixed attachment and suitable for MIK or Racktime system
- with reflective applications
- capacity: 34l, dimensions (LxWxH): 2x 49 x 30 x 18cm

0.839.872/9 olive green 006995

0.839.873/7 ashy grey 006995



## LIM BACKPACK

- urban backpack
- made of water repellent polyester
- incl. bike hooks for transport on the carrier
- with padded shoulder straps and small pocket
- incl. reflective applications
- capacity: 20l, dimensions (LxWxH): 57 x 30 x 16cm

0.839.874/5 olive green 006995

0.839.875/2 ashy grey 006995



## LIM HAMPER FR

- urban front basket bag
- made of water repellent polyester
- incl. adapter for KlickFix and BasEasy system
- with cord fastener and carrying straps
- with reflective application
- capacity: 15,5l, dimensions (LxWxH): 28 x 25,5 x 37cm

0.839.878/6 olive green 006495

0.839.879/4 ashy grey 006495



## LIM HAMPER HR

- urban basket bag
- made of water repellent polyester
- incl. Basil M'IK adapter, possible attachment with Racktime system adapter
- with cord fastener and carrying straps
- with reflective applications
- capacity: 22l, dimensions (LxWxH): 50 x 26,5 x 28cm

0.839.880/2 olive green 008995

0.839.881/0 ashy grey 008995





# For your bikepacking adventure

Our Mile Grinder bikepacking bags are perfect for your gravel or road bike. Thanks to their aerodynamic shape, they are no obstacle on your fast adventures, but offer enough storage space for everything you need on your trip. Whether that's a puncture kit, water bottle or rain jacket – with the Mile Grinders you

do not have to leave anything at home and still keep the minimalistic look. We have also added a new bag to our bikepacking collection: The Mile Grinder Lowrider can, as the name suggests, easily be attached to the lowrider of your bike.



## MILE GRINDER RACE 3

- handlebar bag (3l)
- made of waterproof 1680D polyester
- front pocket with fleece for mobile phone / sun glasses, main compartment with mesh
- reflective elements
- carrying straps incl. to use as a shoulder bag or hip bag
- approx. 250g
- dimensions: (LxWxH): 25 x 8,5 x 13cm

0.739.948/8 black

002995



## MILE GRINDER FRONT

- handlebar twin bag for bikepacking
- made of waterproof 840D nylon, TPU coated
- incl. mounting material and shoulder strap
- approx. 700g
- dimensions: (LxWxH): 62,5 x 28cm / 26 x 9 x 27cm

0.739.942/1 black

008995



## MILE GRINDER TOP TUBE 1.2

- top tube bag for bikepacking
- made of waterproof 600D polyester TPU
- full-length waterproof zipper on the upper side
- toolfree fastening with scratchfree Velcro straps
- approx. 118g
- dimensions: (LxWxH): 20 x 6 x 10cm

0.739.945/4 black

003495



## MILE GRINDER FRAME BAG 2.8

- frame bag for bikepacking
- made of waterproof 600D polyester TPU
- waterproof zipper on the drive side
- toolfree fastening with scratchfree Velcro straps
- approx. 200g
- dimensions: (LxWxH): 35 x 6 x 13cm

0.739.944/7 black

004995



**MILE GRINDER TOOL BAG M**

- saddle bag
- made of waterproof 600D polyester / TPU
- waterproof zipper
- toolfree attachment
- approx. 69g
- capacity: 0,8l, dimensions: (LxWxH): 19 x 5,5 x 10cm

0.739.946/2 black

003995

**MILE GRINDER EXTRA SADDLE BAG**

- spacious saddle bag with one main and 2 side compartments
- made of polyester, incl. rain cover
- toolfree attachment
- approx. 310g
- capacity: 2l, dimensions: (LxWxH): 12 x 8 x 26cm

0.739.947/0 black

003495

**MILE GRINDER BACK 10**

- saddle bag
- made of waterproof PVC
- toolfree fastening with scratchfree Velcro straps
- approx. 520g
- dimensions: (LxWxH): 61 x 15 x 16cm

0.739.943/9 black

007995

NEW

**MILE GRINDER LOWRIDER**

- single bag for fork or lowrider attachment
- made of waterproof polyester
- attachment via universal plastic adapter
- incl. shoulder strap
- capacity: 4l, dimensions (LxWxH): 17 x 10 x 40cm

0.739.949/7 black

005995

**MILE GRINDER COMMUTE 25**

- backpack / drybag
- made of waterproof polyester
- lateral mesh pockets and elastic strap
- adjustable shoulder and pelvic straps
- approx. 600g
- dimensions: (LxWxH): 43 x 22 x 60cm

0.739.949/6 black

005495

# The name says it all

No surprises, just reliable luggage solutions: Our waterproof collection not only impresses with one hundred percent waterproofness, but also with thoughtful features, clever details and a stylish look. In addition to

the carrier and saddle bags that are in demand, our range of bags also includes a backpack. Thus, CONTEC offers a complete range of transport solutions that are suitable for use with and without a bike.



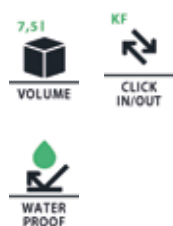

**HANDLEBAR WATERPROOF**

- sporty handlebar bag
- made of waterproof polyester
- wit large main compartment and 3 small inner compartments and small zippered compartment at the front
- incl. adjustable shoulder belt and KlickFix mounting plate
- with transparent card / smartphone compartment in the cover
- with reflective elements and colour accents at the seams and zippers
- capacity: 7,5l, dimensions (LxWxH): 23,5 x 23 x 14cm

0.839.629/3 black / gold 009995



**TRUNK WATERPROOF RT**

- sporty carrier bag
- made of waterproof polyester
- 3 inner compartments
- reflective elements and colour accents at the seams and zippers
- incl. adjustable shoulder belt
- with Racktime Snap-it adapter
- capacity: 15l, dimensions (LxWxH): 34 x 20 x 27cm

0.839.628/5 black / gold 010995



**TRANSIT WATERPROOF**

- single bag
- waterproof polyester / nylon mixture
- attachment via Rixen & Kaul standard carrier system
- with hermetical roll closure
- with extra large removable inner pocket and lateral reflective elements
- capacity: 25l, dimensions (LxWxH): 30 x 16 x 56cm

0.739.797/9 black 007995



**TRAVEL WATERPROOF**

- single bag
- 100% waterproof Tarpaulin / polyester mix
- attachment via Rixen & Kaul standard carrier system
- with hermetic roll closure
- with removable inner pocket and lateral reflective elements
- capacity: 20l, dimensions (LxWxH): 22/30 x 14 x 50cm

0.739.788/8 black 005995



**WATERPROOF 24**

- backpack
- 100% waterproof Tarpaulin / polyester mixture
- adjustable carrying system with light and quick drying mesh inserts
- with hermetical roll closure
- with removable inner pocket and reflective elements
- capacity: 24l, dimensions (LxWxH): 26/30 x 22 x 60cm

0.739.792/0 green / black 005995

0.739.794/6 black 005995



**STOW WATERPROOF**

- saddle bag
- 100% waterproof Tarpaulin / polyester mixture
- toolfree attachment
- with hermetic roll closure
- with reflective elements

0.739.790/4 medium, capacity: 0,5l, dimensions (LxWxH): 11,5 x 9 x 5cm 002495

0.739.791/2 large, capacity: 1,0l, dimensions (LxWxH): 15,5 x 11 x 6cm 002795



**CARRY WATERPROOF**

- length adjustable and light carrying belt
- to hook up to the bag
- comfortable cushion and anti-slip coating

0.739.799/5 black 000995



**CLASSIC EXCLUSIV**

- leather
- with magnetic closure
- suitable for Classic Exclusiv leather saddle series
- capacity: 1l, dimensions (LxWxH): 20 x 7 x 9,5cm

0.327.977/5 coffee	008995
0.327.976/7 gravy	008995
0.327.975/9 honey	008995

**Luggage Lashing straps**



**STRING**

- round fixture strap
- with extra strong hooks
- nylon-casing

0.338.760/2 10 x 600mm, black	000395
0.338.761/0 10 x 600mm, black / green	000395
0.338.762/8 10 x 600mm, black / yellow	000395
0.338.763/6 10 x 600mm, black / blue	000395
0.338.764/4 10 x 800mm, black	000495
0.338.765/1 10 x 800mm, black / green	000495
0.338.766/9 10 x 800mm, black / yellow	000495
0.338.767/7 10 x 800mm, black / blue	000495
0.338.768/5 10 x 1000mm, black	000595
0.338.769/3 10 x 1000mm, black / green	000595
0.338.770/1 10 x 1000mm, black / yellow	000595
0.338.771/9 10 x 1000mm, black / blue	000595



**STRING DELUXE**

- 2-part fixture strap
- with extra strong hooks
- 580mm long

0.338.772/7 black / grey	000595
0.338.773/5 black / blue	000595
0.338.774/3 black / red	000595
0.338.775/0 blue / grey	000595



**STRAP.3**

- triple
- 500mm

0.738.241/9 black / white / grey	000995
----------------------------------	--------



**STRIP.STRAP**

- triple
- 580mm
- with hooks

0.738.242/7 black	000795
-------------------	--------



**STRAP.2**

- double
- 580mm
- rubber

0.738.243/5 black	000795
-------------------	--------

Accessories **Luggage**



**SAFE R PACK**

- suitable for backpacks and baskets
- with elastic band
- waterproof
- size (LxW): 45 x 32cm

0.738.424/1 black / reflex	001995
0.738.425/8 safety yellow	001995





RIM

Suitable for wheels  
in the specified size



## STAND

### Kick it!

Discover now our new side and rear stands RHINO and OX for wheel sizes from 24 to 29 inches. Both model series are height adjustable – RHINO stands are suitable for almost all common bikes. OX stands have

a higher stability and are therefore ideal for e-bikes. We also offer stands for smaller wheel sizes from 12 inches. Each kick stand from our collection is as easy to use as it is to assemble.



OX BACK P.275



ROCK 'N' ROLL P.279

NEW



**OX SIDE**

- max. load 25kg
- with hexagon socket and spring washer
- screws diameter 3/8"
- die-cast aluminium with plastic foot

0.340.001/4 matt black	001995
------------------------	--------

NEW



**RHINO SIDE**

- max. load 20kg
- with hexagon socket and spring washer
- screws diameter 3/8"
- die-cast aluminium with plastic foot

0.340.001/0 black	001495
-------------------	--------



**MAMMUT**

- aluminium die-casting with plastic foot
- with inside hexagon and spring ring
- max. load 20kg

0.340.901/8 black	000995
0.340.902/6 silver	000995



**CROC**

- fine adjustment over rotary mechanism
- aluminium
- max. load 18kg

0.340.922/4 black	001595
-------------------	--------



**ELEFANT**

- aluminium
- with inside hexagon and spring ring
- with plastic foot
- max. load 15kg

0.340.936/4 black	000995
0.340.937/2 silver	000995



**BABYFANT**

- aluminium
- with inside hexagon and spring ring
- with plastic foot
- max. load 15kg

0.340.909/1 black	000995
0.340.906/7 silver	000995

NEW



**OX BACK**

- max. load 25kg
- die-cast aluminium with plastic foot

0.340.001/5 hole distance 18mm, M6 screw diameter	002195
0.340.002/0 hole distance 18mm, M5 screw diameter	002195
0.340.001/6 hole distance 40 mm, M6 screws diameter	002195

NEW



**RHINO BACK**

- max. load 20kg
- die-cast aluminium with plastic foot

0.340.001/1 hole distance 18mm, M6 screw diameter	001795
0.340.001/9 hole distance 18mm, M5 screw diameter	001795
0.340.001/2 hole distance 40mm, M6 screw diameter	001795

NEW



**RHINO OVAL**

- max. load 20kg
- suitable for oval rear stays
- screws diameter 6mm
- die-cast aluminium with plastic foot

0.340.001/3 black 001795



**CKS-018**

- max. load 20kg
- for direct dropouts attachment with 18mm hole distance
- aluminium die-casting with plastic foot

0.340.926/5 black 001695



**CKS-040**

- for direct dropouts attachment with 40mm hole distance
- aluminium die-casting with plastic foot
- max. load 20kg

0.340.928/1 black 001695

NEW



**GIRAFFE**

- max. load 25kg
- universal - attachment to frame triangle
- screws diameter 6mm
- die-cast aluminium with plastic foot

0.340.001/8 black 002195



**CKS-220**

- fine adjustment over rotary mechanism
- suitable for full suspension (chainstay attachment)
- aluminium
- max. load 18kg

0.340.923/2 black 001695



**CKS-240**

- suitable for full suspension bikes (chain stay attachment)
- aluminium die-casting with plastic foot
- max. load 20kg

0.340.932/3 black 001595



**ALLIGATOR**

- fine adjustment via rotary mechanism
- suitable for different frame geometries
- aluminium

0.340.921/6 black 001695



**HIPPO**

- high stability
- steel
- black
- max. load 50kg

0.340.912/5 26" (310mm long) 002995

0.340.915/8 28" (325mm long) 002995





**BIKE SLINGER**

- versatile usable
- simple use
- spring arm and 3-point-contact stabilizes the bike
- suitable for front or rear wheel
- fits for up to 66mm tire width

0.340.979/4 black 004995



**BIKE SLINGER DS**

- extra stable for E-bikes
- simple use
- spring arm and 3-point contact stabilizes the bike
- suitable for front and rear wheel
- fits for up to 61mm tire width

0.340.981/0 black 005495



**FAT BIKE SLINGER**

- especially for Fat bikes
- simple use
- spring arm and 3-point contact stabilizes the bike
- suitable for front and rear wheel
- tire width from 76 to 127mm

0.340.982/8 black 005995



**BIKE SLINGER**

- connecting feet
- for connection of the CONTEC stands "Bike Slinger"

0.340.077/7 set with 4 pieces 000695



**ROCK SOLID**

- with adjustable and varnish protected covered adaption
- suitable for show and parking of the bikes with wheel size 26" - 29"

0.340.980/2 black 004995



**ROCK' N' ROLL**

- ideally suited for presenting and parking of all kinds of sports bicycles with different wheel sizes and widths

0.340.977/8 black 003995



**READY STEADY**

- pluggable in row
- solid construction

0.340.976/0 black 003495



**SHOWMASTER**

- universal
- adaptable rubber mountings for chain and seat stays

0.340.978/6 black 002195

**4**  
PIECES

# Your bike, your artwork

Your flat is too small? Your bike too valuable to park outside? No big deal with our new wall mounts: bikeART and smART are our new bike mounts for your living room and garage wall. With bikeART, Scandinavian design and high-quality materials allow

you to hang your beautiful bike in a way that is not only incredibly practical, but also visually appealing to decorate your living space. The more industrial smART version even carries a load of up to 35 kilograms, so that even your e-bike will find a place on your wall.



NEW



## BIKEART SHELF

- stylish and stable bike rack for wall mounting
- made of high quality steel and walnut wood
- protection of the frame by silicone coating
- incl. strap to stabilize the front wheel
- suitable for top tube Ø up to 55mm
- max. load capacity 25kg
- incl. mounting material

0.340.944/1 black / walnut

003995

NEW

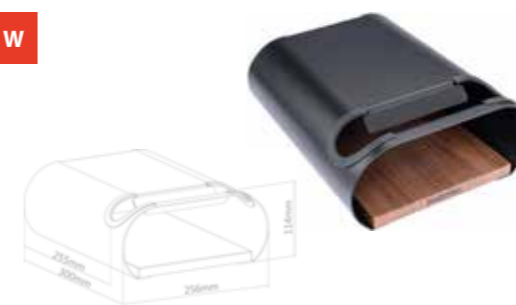

## BIKEART TUBE

- stylish and stable bike rack for wall mounting
- made of high quality steel and walnut wood
- protection of the frame by silicone coating
- incl. strap to stabilize the front wheel
- suitable for top tube Ø up to 55mm
- max. load capacity 25kg
- incl. mounting material

0.340.944/0 black / walnut

003995

NEW



## SMART

- stable bike holder for wall mounting
- made of high quality steel and strong plastic
- no more heavy lifting
- pre-mounted tire stopper protects wheel and wall
- max. load capacity 30kg
- incl. mounting material

0.340.944/2 black

002495

NEW



## SMART FOLD

- stable bicycle holder for wall mounting
- made of high quality steel and strong plastic
- no more heavy lifting
- swiveling and space-saving arms
- pre-mounted tire stopper protects wheel and wall
- max. load capacity 35kg
- incl. mounting material
- black / silver

0.340.944/4 suitable for tire widths: 54-70mm (2,1"-2,8")

004995

0.340.944/5 suitable for tire widths less than 54mm (less than 2,1")

004995

NEW



## SMART HOLD

- sturdy bike rack for wall mounting
- made of high quality steel
- protection of the frame by silicone coating
- incl. belt to stabilize the front wheel
- max. load capacity 25kg
- incl. mounting material

0.340.944/3 black

004995



**WALLIE**

- for hooking the front wheel
- suitable for all bikes
- incl. mounting material

0.340.945/5 silver

001495



**MOULDER**

- to hang over the pedals
- suitable for all bikes
- incl. mounting material

0.340.946/3 black

000995

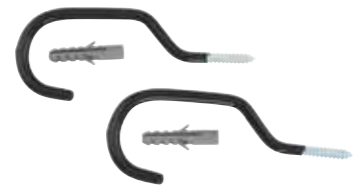

**HANGER**

- PVC-coated
- incl. mounting material

0.340.344/1 2 pieces

000695

**2**  
PIECES







RIM

Mudguards suitable for wheels in the specified size.



## FENDERS

# Don't give dirt a chance

You are on the road with your bike and see from afar that you have to ride through one or two puddles to get to your destination. In these moments, a fender can not only protect you and your clothes, but also your bike from dirt and moisture. Especially for e-bikes, a fender can take away the nervous feeling of damaging your bike with moisture. Our new Specter and Shield mud guards are ideal for (e-)MTB, for example. Anyone

who rides a MTB on trails in the countryside knows how dirty it can get. Specter and Shield from CONTEC are fenders made of all-weather plastic, which can be quickly and easily mounted on the suspension fork and the rear end of your bike with the supplied cable ties. There are three different designs to choose from.



SPECTER P.290



SPLASH PROTECT P.287



**FLAT FENDER**

- fixed mounting
- aluminium
- extremely stable, straight and flat
- incl. stays

0.341.942/1 28", 32mm wide, black	004995
0.341.943/9 28", 42mm wide, black	004995
0.341.944/7 28", 32mm wide, silver	004995
0.341.945/4 28", 42mm wide, silver	004995



**SPLASH PROTECT**

- plastic
- with single clip attachment
- 3,4mm black powder steel stays
- front wheel with mini clip XL safety system

0.341.753/2 20" - 54mm wide, glossy black	003995
0.341.754/0 20" - 54mm, matt black	004595
0.341.755/7 20" - 54mm wide, glossy silver	003995
0.341.756/5 24" - 54mm wide, glossy black	003995
0.341.757/3 24" - 54mm wide, matt black	004595
0.341.758/1 24" - 54mm wide, glossy silver	003995
0.341.759/9 26" - 54mm wide, glossy black	003995
0.341.760/7 26" - 54mm wide, matt black	004595
0.341.761/5 26" - 54mm wide, glossy silver	003995
0.341.762/3 26" - 60mm wide, glossy black	003995
0.341.763/1 26" - 60mm wide, matt black	004595
0.341.764/9 26" - 60mm wide, glossy silver	003995
0.341.765/6 28" - 42mm wide, glossy black	003995
0.341.766/4 28" - 42mm wide, matt black	004595
0.341.767/2 28" - 42mm wide, glossy silver	003995
0.341.768/0 28" - 45mm wide, glossy black	003995
0.341.769/8 28" - 45mm wide, matt black	004595
0.341.770/6 28" - 45mm wide, glossy silver	003995
0.341.771/4 28" - 48mm wide, glossy black	003995
0.341.772/2 28" - 48mm wide, matt black	004595
0.341.773/0 28" - 48mm wide, glossy silver	003995
0.341.774/8 28" - 54mm wide, glossy black	003995
0.341.775/5 28" - 54mm wide, matt black	004595
0.341.776/3 28" - 54mm wide, glossy silver	003995
0.341.777/1 28" - 58mm wide, glossy black	003995
0.341.778/9 28" - 58mm wide, matt black	004595
0.341.779/7 28" - 58mm wide, glossy silver	003995
0.341.780/5 27" / 28" - 35mm wide, glossy black	003995
0.341.781/3 27" / 28" - 35mm wide, matt black	004595
0.341.782/1 27" / 28" - 35mm wide, glossy silver	003995





**SPLASH PROTECT DLX**

- aluminium
- with single clip attachment
- 4mm black satined steel stays
- front wheel with mini clip XL safety system

0.341.783/9 28" - 36mm wide, matt black	005995
0.341.784/7 28" - 36mm wide, matt silver	005995
0.341.785/4 28" - 41mm wide, matt black	005995
0.341.786/2 28" - 41mm wide, matt silver	005995
0.341.787/0 28" - 48mm wide, matt black	005995
0.341.788/8 28" - 48mm wide, matt silver	005995
0.341.789/6 28" - 55mm wide, matt black	005995
0.341.790/4 28" - 55mm wide, matt silver	005995



**D-FENDER II**

- for front wheel
- 26"-29"
- suitable for the most MTBs with suspension forks
- composite plastic
- toolless quick mount
- steering tube inner Ø 1 1/8" or 1,5"

0.341.939/7 black	001795
-------------------	--------



**D-FENDER II**

- for rear wheel
- 26"-29"
- suitable for the most MTBs, also for full suspension
- composite plastic
- universal toolless quick fastening on the seatpost

0.341.940/5 black	001795
-------------------	--------



**D-FENDER II**

- 26"-29"
- suitable for the most MTBs
- set for front and rear wheel D-Fender II

0.341.941/3 black	002995
-------------------	--------



**TREKKING**

- 24"-28"
- complete plastic set
- fork crown mounting
- seat stay / seatpost mounting
- rear guard is over 33mm adjustable

0.341.937/1 28-32mm wide	001495
0.341.938/9 32-36mm wide	001495



**DIRTBOARD DB-02**

- for rear wheel
- 20"-26"
- plastic
- suitable for suspension bikes
- toolless fastening over strap system - suitable for all seatpost diameters
- universal adjusting (2-joint system)

0.341.931/4 black	001495
-------------------	--------





NEW



**SHIELD**

- all weather polypropylene
- dimensions (LxW): 256 x 310cm
- attachment via cable ties to the rear triangle
- incl. cable ties

0.341.934/3 pattern: black	000995
0.341.934/4 lines: black / grey	000995
0.341.934/5	000995

NEW



**SPECTER**

- for front wheel
- all weather polypropylene
- 258cm long
- attachment via cable ties to the suspension fork
- incl. cable ties

0.341.934/0 pattern: black	000995
0.341.934/1 lines: black / grey	000995
0.341.934/2	000995



**MUDBOARD**

- for front wheel
- plastic
- lower tube mounting
- also suitable for oversize frames

0.341.932/2 black	001295
-------------------	--------



**NEO.PROTECT**

- from recycled tarpaulin
- universal attachment
- incl. mounting material
- black

0.343.907/2 suitable for fender width from 60-65mm	001495
0.343.908/0 suitable for fender width from 70-90mm	001595



**CLASSIC EXCLUSIV**

- mudguard
- leather
- incl. 2 screws
- 115 x 115mm

0.343.906/4 coffee	002495
0.343.905/6 gravy	002495
0.343.904/9 honey	002495







## SHIFTING ACCESSORIES

# With SHIFT every gear fits



Reliability from the first to the last gear: our SHIFT spare parts combine optimal function with high durability in the circuit of your bike. SHIFT derailleur cables made of galvanized and pre-lubricated steel form the basis of our range. Ideal for a cost-efficient and robust replacement for a functional shifting system.

SHIFT+ brings even more performance through corrosion-resistant stainless steel from which these cables are made. Ideal for daily use in all weather

conditions due to the anti-rust material of stainless steel. SHIFT++ cables are made of ultra-slippery PTFE coated steel, which ensures robustness and lowest frictional resistance for optimal shifting function even under racing conditions.



SHIFT+ P.294



SHIFT P.297

**50**  
PIECES



**SHIFT++**

- PTFE steel
- Ø 1,1mm
- 2275mm long
- incl. one end cap

0.348.933/3 self-service package, universal, incl. 1 end cap	000595
0.348.953/1 workshop box with 50 pieces, 4x4 standard nipple	029795



**SHIFT++**

- PTFE coated steel
- Ø 1,1mm
- 2275mm / 2500mm long
- with 2500mm outer casing, 8 sealed aluminium cable covers, 2 end caps and 2 O-ring sets

0.348.911/9 black	002695
0.348.912/7 white	002695



**SHIFT+**

- stainless steel
- Ø 1,1mm
- 2275mm / 2500mm long
- with 2500mm outer casing, 10 sealed aluminium cable covers, 2 end caps and 2 O-ring sets

0.348.934/1 black	001995
0.348.935/8 white	001995

**100**  
PIECES



**SHIFT+**

- stainless steel
- Ø 1,1mm
- 2275mm long
- incl. one end cap

0.348.932/5 self-service package, universal, incl. 1 end cap	000495
0.348.952/3 workshop box with 100 pieces, 4x4 standard nipple	049595



**SHIFT**

- steel
- Ø 1,1mm
- 2275mm long
- incl. one end cap

0.348.931/7 PreLube, galvanized	000295
---------------------------------	--------



**SHIFT HS**

- stainless steel
- Ø 1,2mm

0.348.852/5 for Shimano, 2250mm long	000295
0.348.853/3 for SRAM, 2500mm long	000295
0.348.854/1 for Sturmey Archer, 2500mm long	000295



**SHIFT DC**

- outer Ø 5mm
- 1700mm long
- incl. cable cover

0.348.855/8 black	000495
0.348.857/4 silver	000495



**HOUSE SUPPORT**

- for internal gear hubs

0.348.858/2 Sturmey Archer	000495
0.348.859/0 SRAM	000495





**SHIFT**

- workshop box with 40m
- Ø 4mm

0.348.954/9 black	006995
-------------------	--------



**200**  
PIECES



**SHIFT**

- for inner cables
- bottle with 200 pieces

0.348.956/4 transparent	002995
-------------------------	--------

**150**  
PIECES



**SHIFT**

- for Ø 4mm derailleur cable outer casing
- plastic
- bottle with 150 pieces

0.348.958/0 black	002495
-------------------	--------

**100**  
PIECES



**SHIFT**

- for Ø 5mm derailleur cable outer casing
- bottle with 100 pieces

0.348.957/2 silver	002495
--------------------	--------

**50**  
PIECES



**SHIFT S**

- for Ø 4mm derailleur cable outer casing
- sealed
- bottle with 50 pieces

0.348.955/6 black	001995
-------------------	--------



## LOCKS

# Locking safety



Anyone who travels by bike knows that subconscious thrill when their bike is parked in a new place for the first time. With the locks from CONTEC, every parking location can be a safe place. So you don't have to worry about getting home without your bike anymore. At CONTEC, you will find a wide range of lock types,

so that you can flexibly choose one or more locks for your bike according to your needs. Our bike lock collection consists of three different families – our high-performance locks PowerLoc, our classic EcoLocs and our SLOCs with a soft casing and hard core.



### Next level theft protection

To help you better assess the differences between our lock types, we have classified each of our locks on a security scale of 1-10. To evaluate them, we looked at various features such as bar thickness, material, cable diameter, locking and cylinder technology.

- Coffee-Break (short-term safety) 1-3
- Shopping-Stop (medium security level) 4-7
- Overnight/ E-Bike (highest levels, for long connection times and for expensive bikes) 8-10



# Powerloc frame lock



## POWERLOC M

- frame and battery lock set
- Loc-In function for PowerLoc plug-in chain
- tire width: 50mm
- key service
- special hardened steel allows no weakness thru sawing, cutting or impacts
- X2- Power - double locking bolts increase the rip resistance
- **security level: 10**

0.352.774/4 for frame battery	004295
0.352.775/1 for integrated battery (PowerTube)	003995
0.352.776/9 for carrier battery	004295



## POWERLOC M

- frame lock
- Loc-In function for PowerLoc plug-in chain
- tire width: 50mm
- key service
- special hardened steel allows no weakness thru sawing, cutting or impacts
- X2- Power - double locking bolts increase the rip resistance
- security level: 10

0.352.770/2 removable key, self-service package	003595
0.352.771/0 removable key, bulk	003595
0.352.772/8 non-removable key, ART** certification, self-service package	003595
0.352.773/6 non-removable key, ART** certification, bulk	003595



## POWERLOC L

- frame lock
- Loc-In function for PowerLoc plug-in chain
- tire width: 57mm
- key service
- special hardened steel allows no weakness thru sawing, cutting or impacts
- X2- Power - double locking bolts increase the rip resistance
- security level: 10

0.352.780/1 removable key, self-service package	003595
0.352.781/9 removable key, bulk	003595
0.352.782/7 non-removable key, ART** certification, self-service package	003595
0.352.783/5 non-removable key, ART** certification, bulk	003595

# POWERLOC

The CONTEC PowerLocs are the powerhouses among bicycle locks. Our high-security lock series combines maximum break-open security with elegant design. Our additional plug-in chains for the PowerLoc frame locks offer you an additional plus in theft protection.

The U-lock from the PowerLoc series was recently rated by two MTB magazines with the note "very good" and also awarded as a purchase and price-performance tip! The MountainBike and the Bike had the lock tested in terms of security, features and price.



## POWERLOC XL

- frame lock
- Loc-In function for PowerLoc plug-in chain
- tire width: 70mm
- key service
- special hardened steel allows no weakness thru sawing, cutting or impacts
- X2- Power - double locking bolts increase the rip resistance
- security level: 10

0.352.785/0 removable key, self-service package	005995
0.352.786/8 removable key, bulk	005995
0.352.787/6 non-removable key, ART** certification, self-service package	005995
0.352.788/4 non-removable key, ART** certification, bulk	005995



## POWERLOC

- plug-in chain also suitable for CONTEC PowerLoc and Abus frame locks
- Ø 6mm
- Loc-In function
- special hardened steel allows no weakness thru sawing, cutting or impacts
- nylon coating to prevent the scratches

0.352.796/7 85cm long, 793g	003995
0.352.797/5 130cm long, 1170g	004495





### X4 POWER QUATTRO BOLT LOCKING

The Quattro Bolt Locking System works with a quad locking device of the bracket. The locking pins secure each side twice, allowing maximum pull-out strength.

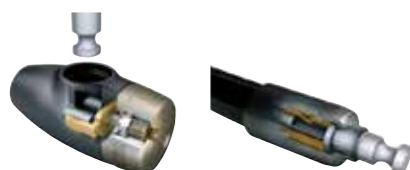

### X2 POWER DOUBLE BOLT LOCKING

The Double Bolt Locking System disposes of a double bolt locking. This mechanism increases the maximum pull-out strength as the bracket becomes locked on both sides.



### BUMP BLOCK M-ZYLINDER

Bump block is the name of the precision lock cylinder that is also used in the automotive industry. This locking cylinder has over 100.000 locking combinations and offers high security against manipulation. The locking system is enclosed in a cover made of hardened steel for additional protection and is nearly resistant against drilling, tearing or impact attacks.



### STEEL BALL CLICK-COMBO-GEAR-SYSTEM

The Steel Ball Click-Combo-Gear system is used in the CONTEC PowerLoc combination locks. It offers high security and excellent protection against impact and tear-out attacks.

We designed our PowerLoc family to offer best-in-class protection against bike theft with the highest degree of user-friendliness in mind. For instance all PowerLocs are equipped with reversible security keys for easy access to your bike. We offer a broad variety of lock options under the PowerLoc label. Our PowerLocs rely on sophisticated technology that hinders the skillful and the forceful thief alike - our X2-Power Technology secures your bike with the

double bolt locking system and on some models also use our strongest X4-Power Technology with four locking bolts. The steel cased BumpBlock M cylinder protects the lock against drilling, cutting or impacts. Whether u-lock, chain or cable - CONTEC PowerLocs use the hardest materials with a smart mix of different layers, to ensure maximum theft protection, like our chain locks, with links from specially.



All test results from the Bike: 2x "test winner" with 54 points; 4x "very good" with 50 points, (including 1x "price-performance tip"); 7x "good" with 49, 48, 47, 45, 42, 41 & 40 points; 3x "satisfactory" with 35, 34 & 33 points

All test results from the MountainBike: 1x "outstanding", (of which 1x "test winner"); 9x "very good", (of which 1x "test winner" & 3x "purchase tip"; 6x "good"; 1x "satisfactory"; 1x "weak"

#### POWERLOC

- U-lock
- special hardened steel allows no weakness thru sawing, cutting or impacts
- X4-Power - quattro bolt locking system works with a four point locking device, the locking bolts secure each side twice and allows max. rip resistance
- BumpBlock M-Zylinder - in steel capped precision locking cylinder
- security level: 10
- incl. bracket

0.352.720/7 115mm wide, 230mm high, 1147g	003995
0.352.721/5 115mm wide, 230mm high, with additional loop cable 120cm x 10mm, 1175g	004495



#### POWERLOC

- armoured cable lock
- flexible steel cable protected by steel links
- X2-Power - has double locking bolts and increases the rip resistance
- BumpBlock M-Zylinder - in steel capped precision locking cylinder

0.352.725/6 Ø 25mm, 120cm long, 1725g, security level: 8	003995
0.352.726/4 Ø 20mm, 100cm long, 1065g, security level: 7	003195



#### POWERLOC

- cable lock, 85cm long
- flexible steel cable with durable vinyl coating
- X2-Power - double bolt locking system increases rip resistance
- BumpBlock M-Zylinder - in steel capped precision locking cylinder

0.352.731/4 Ø 20mm, 965g, security level: 8	002995
0.352.732/2 Ø 15mm, 670g, security level: 7	002295
0.352.733/0 Ø 12mm, 300g, security level: 6	001795



#### POWERLOC

- combination cable lock, 85cm long
- flexible steel cable with durable vinyl coating
- X2-Power - double bolt locking system increases rip resistance
- 4-point free settable code

0.352.735/5 Ø 15mm, security level: 6	002295
0.352.736/3 Ø 12mm, security level: 5	001795



**POWERLOC**

- curly cable lock, 185cm long
- flexible steel cable with robust vinyl coating
- X2-Power - double bolt locking system has double locking bolts and increases the rip resistance
- BumpBlock M-cylinder - in steel capseled precision locking cylinder incl. bracket

0.352.727/2 Ø 15mm, 930g, security level: 7	002995
0.352.728/0 Ø 12mm, 570g, security level: 6	002295



**POWERLOC**

- combination curly cable lock, 185cm long
- flexible steel cable with durable vinyl coating
- X2-Power - double bolt locking system increases the rip resistance
- 4-point free settable code
- incl. bracket

0.352.729/8 Ø 15mm, security level: 7	002995
0.352.730/6 Ø 12mm, security level: 6	002295



**POWERLOC**

- chain lock
- special hardened steel allows no weakness thru sawing, cutting or impacts
- X2-Power - double bolt locking system increases the rip resistance
- BumpBlock M-cylinder - in steel capseled precision locking cylinder

0.352.724/9 Ø 10mm, 110cm long, 3130g, security level: 10	005495
0.352.738/9 Ø 6mm, 75cm long, 560g, security level: 7	002995



**POWERLOC**

- chain lock
- special hardened steel allows no weakness thru sawing, cutting or impacts
- X2-Power has double locking bolts and increases the rip resistance

0.352.766/0 Ø 7,5mm, 90cm long, 1000g, security level: 8	003295
0.352.767/8 Ø 7,5mm, 120cm long, 1430g, security level: 8	003795
0.352.764/5 Ø 5,5mm, 90cm long, 660g, security level: 7	002495
0.352.765/2 Ø 5,5mm, 120cm long, 820g, security level: 7	002795



**POWERLOC**

- combination chain lock, Ø 6mm, 75cm long
- special hardened steel allows no weakness thru sawing, cutting or impacts
- X2-Power -double bolt locking system increases the rip resistance
- 4-point free settable code
- security level: 8

0.352.739/7 560g	002995
------------------	--------



**POWERLOC**

- loop cable
- Ø 10mm
- flexible steel cable with robust vinyl coating

0.352.737/1 120cm long, 280g	000995
------------------------------	--------



# ECOLOC

The EcoLocs will not leave stranded – no matter which lock model you choose. The EcoLoc U-lock is equipped with an X2-Power locking mechanism with double bolt locking. The hardened special steel of the shackle withstands attacks through sawing, cutting or impacts. For all lovers of flexibility, who have

a great need for safety, EcoLoc armoured cable locks are the perfect choice: high-flexibility steel cable, protected by special hardened steel joints, offer high-level protection for your bike. The high-precision lock cylinder BumpBlock M is protected by a steel casing against drilling, cutting or impacts.



## ECOLOC

- U-lock
- special hardened steel allows no weakness thru sawing, cutting or impacts
- X2-Power - double bolt locking system increases the rip resistance
- security level: 9
- incl. bracket

0.352.750/4 115mm wide, 230mm high, 914g 002495



## ECOLOC

- armoured cable lock
- flexible steel cable protected by steel links
- BumpBlock M-cylinder - in steel capped precision locking cylinder

0.352.751/2 Ø 25mm, 110cm long, 965g, security level: 7 002195

0.352.752/0 Ø 18mm, 100cm long, 637g, security level: 6 001995



## ECOLOC

- cable lock, 85cm long
- flexible steel cable with durable vinyl coating

0.352.757/9 Ø 20mm, 925g, security level: 6 001995

0.352.758/7 Ø 15mm, 489g, security level: 5 001795

0.352.759/5 Ø 12mm, 275g, security level: 4 001595



## ECOLOC

- combination cable lock, 85cm long
- flexible steel cable with durable vinyl coating
- 4-point free settable code

0.352.761/1 Ø 15mm, 430g, security level: 5 001795

0.352.762/9 Ø 12mm, 360g, security level: 4 001595



## ECOLOC

- curly cable lock, 185cm long
- flexible steel cable with durable vinyl coating
- incl. bracket

0.352.753/8 Ø 12mm, 529g, security level: 6 001695

0.352.754/6 Ø 10mm, 435g, security level: 5 001595



## ECOLOC

- combination curly cable lock, 185cm long
- flexible steel cable with durable vinyl coating
- 4-point free settable code
- incl. bracket

0.352.755/3 Ø 12mm, 561g, security level: 6 001795

0.352.756/1 Ø 10mm, 311g, security level: 5 001695



# SLOC

Hard core and soft cover: our stylish SLoc bike locks are covered with an environmentally friendly manufactured silicone that protects your bike from scratches. The pleasant silicone is insensitive to dirt, UV radiation or contamination as well as an effective weather protection for the lock housing. The hardened

steel inside provides a high level of security in addition to the soft casing. Despite the extensive technology, all our SLocs with key or combination lock option are particularly compact, so they find their place on every bike or in every bag.



## SLOC

- U-lock, 83 x 153mm
- weatherproof silicone cover
- 2 reversible key
- 846g
- security level: 8

0.352.917/9 black 005995



## SLOC

- cable lock Ø 21mm, 70cm long
- weatherproof silicone cover
- reinforced lock head
- 2 reversible keys
- 560g
- security level: 4

0.352.915/3 black 003495



## SLOC

- combination cable lock Ø 12mm, 50cm long
- weatherproof silicone cover
- 4-point free settable number combination
- 238g
- security level: 4

0.352.914/6 black 002495



## SLOC

- curly cable lock Ø 10mm, 150cm long
- weather resistant silicone cover
- incl. universal bracket
- 2 reversible keys
- 300g
- security level: 3

0.352.916/1 black 001995



## SLOC

- chain lock Ø 5mm, 100cm long
- weather resistant silicone cover
- robust nylon sleeve protects the frame against scratches
- 2 reversible keys
- 585g
- security level: 5

0.352.918/7 black 002495



## SLOC

- combination cable lock Ø 5mm, 100cm long
- weather and UV resistant
- robust nylon sleeve protects the frame against scratches
- 4-point adjustable number combination
- 585g
- security level: 5

0.352.919/5 black 002495





**NEOLOC**

- cable lock Ø 21mm, 70cm long
- weather resistant silicone cover
- reinforced lock head
- 2 reversible keys
- 560g
- security level: 4

0.352.968/2 black	002795
0.352.970/8 neored	002795
0.352.972/4 neoblue	002795
0.352.973/2 neoyellow	002795



**NEOLOC**

- cable lock Ø 12mm, 60cm long
- weather resistance silicone cover
- 2 reversible keys
- 200g
- security level: 3

0.352.947/6 neogreen	001595
0.352.949/2 neoyellow	001595



**NEOLOC**

- curly cable lock Ø 10mm, 150cm long
- weather resistance silicone cover
- incl. universal bracket
- 2 reversible keys
- 300g
- security level: 3

0.352.982/3 neored	001795
0.352.983/1 neogreen	001795
0.352.985/6 neoyellow	001795



**SHERLOCK**

- folding lock, 850mm long
- extra safety locking cylinder with InX-locking system
- Tredur special steel for more safety
- compact folded size (20 x 8,5 x 4cm)
- incl. bracket
- 1312g
- security level: 8

0.352.106/9 black	007995
-------------------	--------



**BLOCKLOCK**

- folding lock 640mm long
- extra secure locking cylinder
- steel links with plastic cover
- compact folded size (55 x 55 x 55mm)
- 680g
- security level: 6

0.352.989/8 black	005995
-------------------	--------



**BRICKLOCK**

- folding lock, 780mm long
- extra secure locking cylinder
- steel links with plastic cover
- compact folded size (HxWxL) 45 x 60 x 110mm
- 800g
- security level: 7

0.352.990/6 black	005995
-------------------	--------



**KEGLOCK**

- folding lock, 600mm long
- extra secure locking cylinder
- steel links with plastic cover
- compact folded size (Ø 7mm x H 5cm)
- incl. bracket
- 640g
- security level: 6

0.352.988/0 black	003995
-------------------	--------

Multifunctional locks Locks



**RADIO LOCK**

- multifunction lock
- loop for diverse fastening options
- free selectable 3-digit code
- slowed roll-up mechanism
- security level: 3

0.352.997/1 M - 70cm long, 67g	001295
0.352.998/9 L - 110cm long, 88g	001495





## WHEELS

# Wheels are the key to a good riding experience



They strongly influence the agility and steering precision of a wheel. Good wheels must therefore be well mounted, light and stiff. CONTEC offers almost all the necessary building blocks for this. The hubs run on high quality, sealed industrial bearings. For extra long running performance, many hubs are even 4-times beared. Available in all common axle diameters, with Shimano and Sram freewheel bodies, CONTEC offers the right hub for every application.

With matching axles, end caps and a single freewheel body, CONTEC also provides the necessary spare parts. Color-matched to the Select series CONTEC also offers the possibility to set visual accents with screw axles. But weight reduction is also easy with the aluminum quick release with titanium axle. Good rims are

stiff and light. The stiffness of a wheel and thus the steering precision of a bicycle is strongly influenced by the rim. If the rim is not stiff enough, the ride will be spongy.

A rim that is too heavy, on the other hand, i.e. a large rotating mass, has to be re-accelerated every time it is stepped on, and the bike feeling becomes sluggish. The hollow section rims from CONTEC offer an optimal ratio of low weight and the necessary stiffness to build wheels that are fun. Thus, CONTEC has all the building blocks for high-quality and smooth-running wheels. With screw axles of the Select series is also a visual upgrade with small purse made quickly.



M.CORE P.316



RT SAFE P.327



## Wheel XETA CORE 30 // 27,5" BOOST

Rim CONTEC Xeta, 30 x 584 mm, aluminium 6063 T66, SV, spokes 2 mm black, 32 holes

		Hub	Disc brake mount	Cassette body	Speed	Installation width	Axle	
0.360.306/7	FW	CORE CL	Centerlock			110 mm Boost	f. 15 mm Thru axle	008995
0.360.306/8		CORE DB	6-holes					
0.360.306/0	RW	CORE CL	Centerlock	Shimano MicroSpline	12	148 mm Boost	f. 12 mm Thru axle	012995
0.360.306/1				Shimano HG	8-11			
0.360.306/2				SRAM XD	11-12			
0.360.306/3		CORE DB	6-holes	Shimano MicroSpline	12			
0.360.306/4				Shimano HG	8-11			
0.360.306/6				SRAM XD	11-12			

## Wheel XETA CORE 30 // 29" BOOST

Rim CONTEC Xeta Max, 30 x 622 mm, aluminium 6063 T66, SV, spokes 2 mm black, 32 holes

		Hub	Disc brake mount	Cassette body	Speed	Installation width	Axle	
0.360.307/7	FW	CORE CL	Centerlock			110 mm Boost	f. 15 mm Thru axle	008995
0.360.307/8		CORE DB	6-holes					
0.360.307/0	RW	CORE CL	Centerlock	Shimano MicroSpline	12	148 mm Boost	f. 12 mm Thru axle	012995
0.360.307/1				Shimano HG	8-11			
0.360.307/2				SRAM XD	11-12			
0.360.307/4		CORE DB	6-holes	Shimano MicroSpline	12			
0.360.307/5				Shimano HG	8-11			
0.360.307/6				SRAM XD	11-12			



## Wheel EXIT CORE 21 // 27,5"

Rim CONTEC Exit, 21 x 584 mm, aluminium 6063 T66, SV, spokes 2 mm black, 32 holes

		Hub	Disc brake mount	Cassette body	Speed	Installation width	Axle	
0.360.311/7	FW	CORE CL	Centerlock			100 mm	f. 15 mm Thru axle	007995
0.360.311/8		CORE DB	6-holes					
0.360.311/0	RW	CORE CL	Centerlock	Shimano MicroSpline	12	142 mm	f. 12 mm Thru axle	011995
0.360.311/1				Shimano HG	8-11			
0.360.311/2				SRAM XD	11-12			
0.360.311/3		CORE DB	6-holes	Shimano MicroSpline	12			
0.360.311/4				Shimano HG	8-11			
0.360.311/6				SRAM XD	11-12			

## Wheel EXIT CORE 21 // 29"

Rim CONTEC Exit Master, 21 x 622 mm, aluminium 6063 T66, SV, spokes 2 mm black, 32 holes

		Hub	Disc brake mount	Cassette body	Speed	Installation width	Axle	
0.360.313/7	FW	CORE CL	Centerlock			100 mm	f. 15 mm Thru axle	007995
0.360.313/8		CORE DB	6-holes					
0.360.313/0	RW	CORE CL	Centerlock	Shimano MicroSpline	12	142 mm	f. 12 mm Thru axle	011995
0.360.313/2				Shimano HG	8-11			
0.360.313/3				SRAM XD	11-12			
0.360.313/4		CORE DB	6-holes	Shimano MicroSpline	12			
0.360.313/5				Shimano HG	8-11			
0.360.313/6				SRAM XD	11-12			

## Wheel EXIT CORE 25 // 27,5"

Rim CONTEC Exit, 25 x 584 mm, aluminium 6063 T66, SV, spokes 2 mm black, 32 holes

		Hub	Disc brake mount	Cassette body	Speed	Installation width	Axle	
0.360.314/6	FW	CORE CL	Centerlock			100 mm	f. 15 mm Thru axle	007995
0.360.314/7		CORE DB	6-holes					
0.360.314/0	RW	CORE CL	Centerlock	Shimano MicroSpline	12	142 mm	f. 12 mm Thru axle	011995
0.360.314/1				Shimano HG	8-11			
0.360.314/2				SRAM XD	11-12			
0.360.314/3		CORE DB	6-holes	Shimano MicroSpline	12			
0.360.314/4				Shimano HG	8-11			
0.360.314/5				SRAM XD	11-12			

## Wheel EXIT CORE 25 // 29"

Rim CONTEC Exit Master, 25 x 622 mm, aluminium 6063 T66, SV, spokes 2 mm black, 32 holes

		Hub	Disc brake mount	Cassette body	Speed	Installation width	Axle	
0.360.317/7	FW	CORE CL	Centerlock			100 mm	f. 15 mm Thru axle	007995
0.360.317/8		CORE DB	6-holes					
0.360.317/0	RW	CORE CL	Centerlock	Shimano MicroSpline	12	142 mm	f. 12 mm Thru axle	011995
0.360.317/1				Shimano HG	8-11			
0.360.317/3				SRAM XD	11-12			
0.360.317/4		CORE DB	6-holes	Shimano MicroSpline	12			
0.360.317/5				Shimano HG	8-11			
0.360.317/6				SRAM XD	11-12			

# Here it runs smoothly

NEW

## M.CORE CL

- aluminium rear hub, 32 holes
- Center Lock
- 12mm thru axle
- installation width 148mm boost
- black

0.747.620/0	12-speed Shimano Micro Spline, approx. 337g	015995
0.747.620/1	8-/9-/10-/11-speed Shimano HG, approx. 329g	015995
0.747.620/2	11-/12-speed SRAM XD, approx. 321g	015995



NEW



## M.CORE DB

- aluminium rear hub, 32 holes
- 6-hole disc brake mount
- 12mm thru axle
- installation width 148mm boost
- black

0.747.620/4	12-speed Shimano Micro Spline, approx. 349g	015995
0.747.620/5	8-/9-/10-/11-speed Shimano HG, approx. 343g	015995
0.747.620/6	11-/12-speed SRAM XD, approx. 336g	015995

NEW



## CORE CL

- aluminium rear hub, 32 holes
- Center Lock
- 12mm thru axle
- black

0.747.622/0	12-speed Shimano Micro Spline, installation width 142mm, approx. 397g	007995
0.747.622/1	8-/9-/10-/11-speed Shimano HG, installation width 142mm, approx. 373g	007995
0.747.622/2	11-/12-speed SRAM XD, installation width 142mm, approx. 357g	007995
0.747.622/3	12-speed Shimano Micro Spline, installation width 148mm boost, approx. 405g	007995
0.747.622/4	8-/9-/10-/11-speed Shimano HG, installation width 148mm boost, approx. 381g	007995
0.747.622/5	11-/12-speed SRAM XD, installation width 148mm boost, approx. 366g	007995

NEW



## CORE DB

- aluminium rear hub, 32 holes
- 6-hole disc brake mount
- 12mm thru axle
- black

0.747.623/0	12-speed Shimano Micro Spline, installation width 142mm, approx. 418g	007995
0.747.623/1	8-/9-/10-/11-speed Shimano HG, installation width 142mm, approx. 394g	007995
0.747.623/2	11-/12-speed SRAM XD, installation width 142mm, approx. 378g	007995
0.747.623/4	12-speed Shimano Micro Spline, installation width 148mm boost, approx. 426g	007995
0.747.623/5	8-/9-/10-/11-speed Shimano HG, installation width 148mm boost, approx. 403g	007995
0.747.623/6	11-/12-speed SRAM XD, installation width 148mm boost, approx. 387g	007995

## FR

- aluminium rear hub, 32 holes
- robust Shimano / Sram 8-/9-/10-speed compatible freewheel body
- NSK-Japan bearings - 4-times sealed bearings
- 6-hole attachment

0.747.603/9	X12 - black, 142mm installation width, for 12mm thru axle, approx. 433g	008995
-------------	---	--------

NEW



## M.CORE

- aluminium front hub, 32 holes
- for 15mm thru axle
- installation width 110mm boost
- black

0.746.620/0	CL - Center Lock, approx. 192g	007995
0.746.620/1	DB - 6-hole disc brake, approx. 211g	007995

NEW



## CORE

- aluminium front hub
- 32 holes
- black

0.746.621/0	CL - Center Lock, installation width 100mm, 15mm thru axle, approx. 165g	003995
0.746.621/1	CL - Center Lock, installation width 110mm boost, 15mm thru axle, approx. 178g	003995
0.746.621/3	DB - 6-hole disc brake mount, installation with 100mm, 12mm thru axle, approx. 185g	003995
0.746.621/4	DB - 6-hole disc brake mount, installation width 110mm boost, 15mm thru axle, approx. 190g	003995



**FR X20**

- aluminium front hub, 32 holes
- for 20mm thru axle
- sealed industrial bearings
- 6-hole attachment
- converted over end caps for 15 x 100mm full-floating axle
- 190g

0.746.600/6 black, 110mm installation width 004995



**TR X15**

- aluminium front hub, 32 holes
- for 15mm thru axle
- sealed industrial bearings
- 6-hole attachment
- converted for QR
- 190g

0.746.603/0 black, 100mm installation width 004995

NEW



Abb. ähnlich

**M.CORE**

- freewheel body
- aluminium
- also for Contec hubs "M.Core"
- black

0.747.621/0 12-speed Shimano Micro Spline, approx. 105g 009995

0.747.621/2 8-/9-/10-/11-speed Shimano HG, approx. 89g 006995

0.747.621/3 11-/12-speed SRAM XD, approx. 82g 006995

NEW



Abb. ähnlich

**CORE**

- freewheel body
- CrMo steel
- also for CONTEC hub "Core"
- black

0.747.624/0 12-speed Shimano Micro Spline, approx. 196g 006995

0.747.624/1 8-/9-/10-/11-speed Shimano HG, approx. 173g 005995

0.747.624/2 11-/12-speed SRAM XD, approx. 157g 005995



**TR**

- freewheel body
- aluminium
- for CONTEC hub "TR"

0.747.629/4 8-/9-/10-speed Shimano HG 003495

0.747.614/6 11-/12-speed SRAM XD 003995



**FR**

- freewheel body
- CrMo
- for CONTEC "FR" hub

0.747.630/2 8-/9-/10-speed Shimano HG 002995



**TR X15**

- front caps
- spare part for CONTEC hub "TR"

0.746.606/3 right 000495

0.746.605/5 left 000595



**FR X20-2-15**

- front caps
- accessories / conversion kit for CONTEC hub "FR"

0.746.601/4 left 000595

0.746.602/2 right 000595



**FR X20**

- front caps
- spare part for CONTEC hub "FR"

0.746.608/9 right 000495

0.746.607/1 left 000595





**TR XD/HG**

- conversion kit
- allows the adaptation of CONTEC TR XD as also TR HG rear hub to the specification referred

0.747.610/4 5,2 x 135, incl. QR	001995
0.747.612/0 12x135, without threaded / thru axle	003995



**TR HG**

- supplies for CONTEC hub "TR"
- for 11-speed Shimano freewheel body (0.747.615/3)

0.747.616/1 washer for mounting of 8-/9-/10-speed cassettes	000495
---	--------



**AD-ONE SPEED**

- single speed adapter kit for 8-/9-speed cassette hubs Shimano fitting
- compatible with most common cassette hubs, (also Halo wheels)
- CNC-aluminium spacer ensures a proper chainline
- only for 3/32" chains, not for 5/64" 9-speed derailleur chains

0.345.904/7 incl. 2 sprockets (16 and 18 teeth)	001995
---	--------

**Wheels QRs**



**THRU FR**

- front QR
- aluminium 6061
- steel axle

0.344.900/6 silver	000695
--------------------	--------



**SQR SELECT + S**

- incl. QR wrench
- front axle M5 x 112mm
- rear axle M5 x 135mm
- seatpost M6 x 45mm

0.345.928/6 limousine black	001995
0.345.938/5 odd orange	001995



**SQR+ M**

- incl. QR wrench
- QR for front axle M5 x 110mm
- QR for rear axle M5 x 145mm
- QR for seatpost M6 x 45mm

0.345.939/3 black	001995
-------------------	--------



**SQR+ L**

- incl. QR wrench
- for front axle M5 x 115mm
- for rear axle M5 x 151mm
- for seatpost M6 x 45mm

0.345.940/1 black	001995
-------------------	--------



**SQR LITE SELECT**

- QR lever
- front wheel axle M5 x 115mm
- rear wheel axle M5 x 151mm

0.345.211/7 rocket silver	001595
0.345.212/5 limousine black	001595
0.345.213/3 blue steel	001595
0.345.214/1 riot red	001595
0.345.215/8 heart of gold	001595
0.345.216/6 ultra violet	001595
0.345.217/4 guerilla green	001595

**THRU RW**

- rear wheel QR
- aluminium 6061
- steel axle

0.345.901/3 silver

000695

**SQR PIN**

- safety QR lever
- suitable for CONTEC Security Plus

0.745.920/9 black

000695

**THRUBEE FR**

- front thru axle
- 1,5mm thread pitch
- 10mm thread
- black

0.747.317/6 15 x 110mm, 148mm long

002995

0.747.318/4 15 x 110mm, 158mm long, boost

002995

0.747.315/0 15 x 100mm, 148mm long, with quick release lever

002995

0.747.316/8 15 x 110mm, 158mm long, boost, with quick release lever

002995

**THRUBEE RW**

- rear thru axle
- 1,75mm thread pitch
- 20mm thread
- black

0.747.319/2 12 x 142mm, 174mm long

002995

0.747.320/0 12 x 148mm, 180mm long, boost

002995

0.747.322/6 12 x 142mm, 174mm long, with quick release lever

002995

0.747.321/8 12 x 148mm, 180mm long, boost, with quick release lever

002995

**THRAX FR**

- front axle
- Ø 9,5mm
- medium carbon steel

0.344.901/4 130mm long

000595

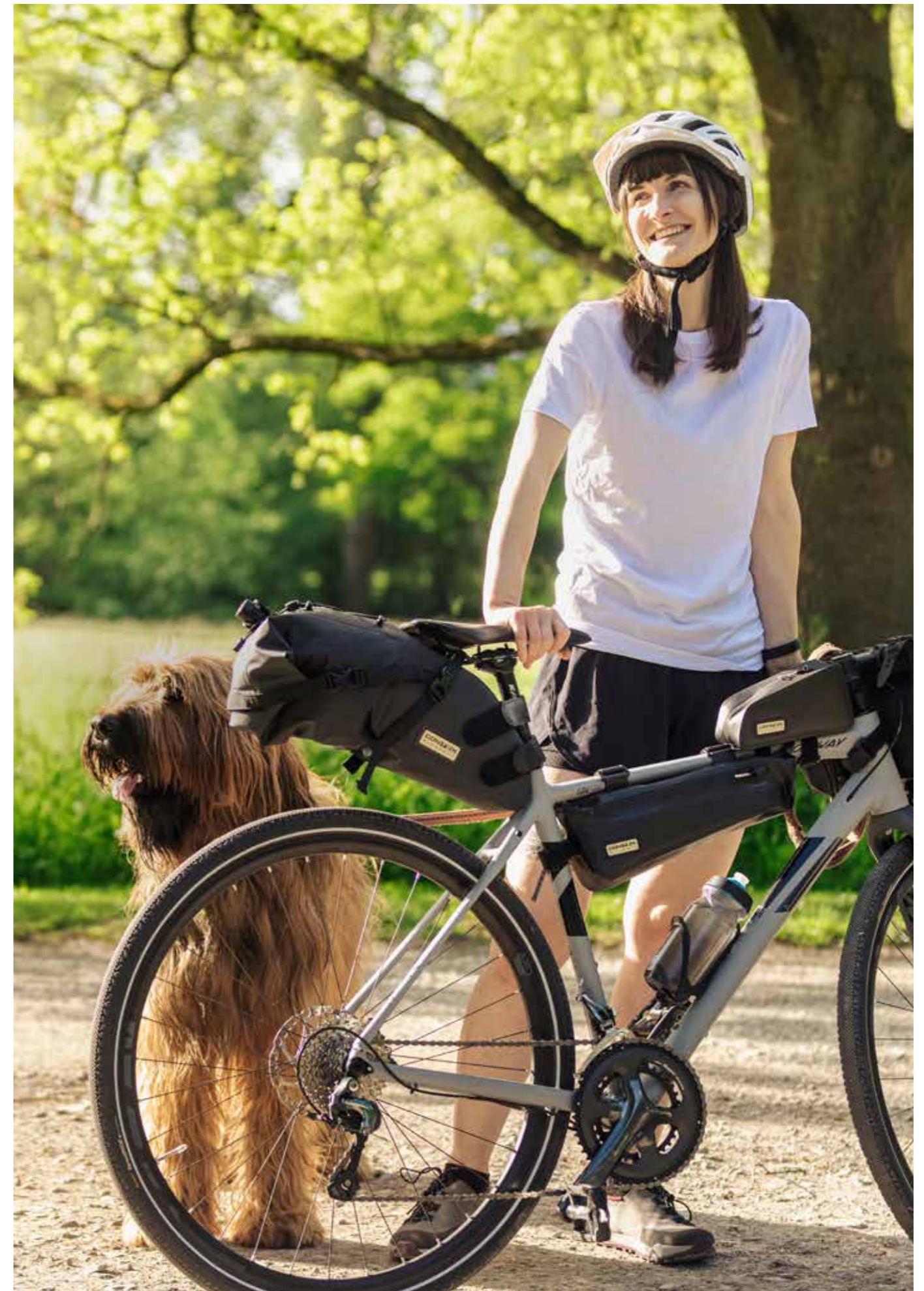



# Keep on Rolling

**NEW**



## EXIT

- 27,5"
- 32 holes
- aluminium doublewall
- for disc brake
- max. load up to 150kg
- black

0.349.817/0	584-21, ERD (incl. spoke holes) 570mm, approx. 503g	002995
0.349.817/1	584-23, ERD (incl. spoke holes) 571mm, approx. 532g	002995
0.349.817/2	584-25, ERD (incl. spoke holes) 568mm, approx. 553g	003995



**NEW**



## XETA MAX

- 29"
- 32 holes
- aluminium, doublewall
- for disc brake
- tubeless ready
- max. load up to 150kg
- black

0.349.816/3	622-25, ERD (incl. spoke holes) 608mm, approx. 569g	003995
0.349.816/4	622-30, ERD (incl. spoke holes) 604mm, approx. 616g	003995
0.349.816/5	622-35, ERD (incl. spoke holes) 604mm, approx. 674g	003995



**NEW**

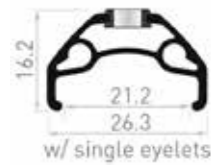

**NEW**



## EXIT MASTER

- 29"
- 32 holes
- aluminium, doublewall
- for disc brake
- max. load up to 150kg
- black

0.349.817/3	622-21, ERD (incl. spoke holes) 608mm, approx. 536g	002995
0.349.817/4	622-23, ERD (incl. spoke holes) 609mm, approx. 566g	002995
0.349.817/5	622-25, ERD (incl. spoke holes) 607mm, approx. 589g	003995

## XETA

- 27,5"
- 32 holes
- aluminium, doublewall
- for disc brake
- tubeless ready
- max. load up to 150kg
- black

0.349.816/0	584-25, ERD (incl. spoke holes) 570mm, approx. 534g	003995
0.349.816/1	584-30, ERD (incl. spoke holes) 566mm, approx. 579g	003995
0.349.816/2	584-35, ERD (incl. spoke holes) 566mm, approx. 633g	003995

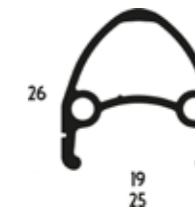
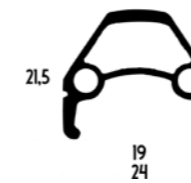

## CLASSIC Z19

- 19-559 (26"x1,75)
- aluminium, doublewall
- double eyelets for DV
- CNC sidewall
- with wear indicator

0.349.800/3	anodized silver	003395
0.349.801/1	black	003395

## CLASSIC X19

- 19-559 (26"x1,75), 36 holes
- aluminium tall sidewall
- for DV
- CNC sidewall
- with wear indicator

0.349.808/6	anodized silver	003395
0.349.809/4	black	003395



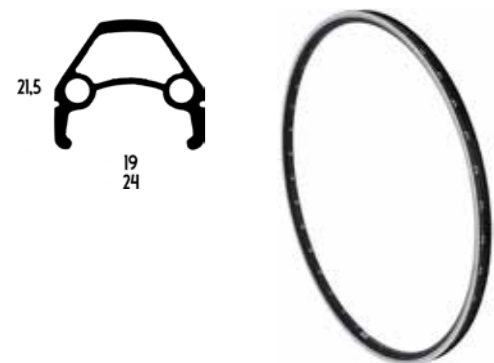

**CLASSIC Z19**

- 19-622 (28"x1,75)
- aluminium, doublewall
- double eyelets for DV
- CNC sidewall
- with wear indicator

0.349.816/9 32 holes, anodized silver	003395
0.349.802/9 36 holes, anodized silver	003395
0.349.803/7 36 holes, black	003395



**CLASSIC S19**

- 19-622 (28"x1,75), 36 holes
- aluminium, doublewall
- double eyelets for DV
- CNC sidewall
- with wear indicator

0.349.814/4 anodized silver	002995
0.349.815/1 black	002995

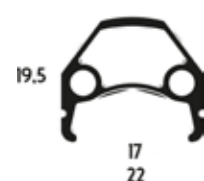

**CLASSIC L17**

- 17-622 (28"x1,75), 36 holes
- aluminium, doublewall
- double eyelets for DV
- CNC sidewall
- with wear indicator

0.349.804/5 32 holes, anodized silver	003395
0.349.805/2 32 holes, black	003395
0.349.806/0 36 holes, anodized silver	003395
0.349.807/8 36 holes, black	003395

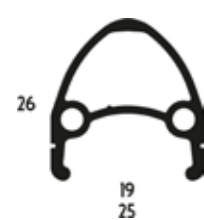

**CLASSIC X19**

- 19-622 (28"x1,75), 36 holes
- aluminium tall sidewall
- for DV
- CNC sidewall
- with wear indicator

0.349.810/2 anodized silver	003395
0.349.811/0 black	003395



**RT SAFE**

- rim tape
- PVC (high pressure)

0.853.600/5 12", 23mm wide	000395
0.853.601/3 16", 20mm wide	000395
0.853.602/1 20", 16mm wide	000395
0.853.603/9 20", 20mm wide	000395
0.853.604/7 24", 16mm wide	000395
0.853.605/4 26", 20mm wide	000395
0.853.606/2 26", 14mm wide	000395
0.853.607/0 28", 20mm wide	000395
0.853.608/8 28", 14mm wide	000395







VOLUME

The volume icon indicates the available container sizes of the care products.



## CARE AGENTS / PUNCTURE PROTECTION

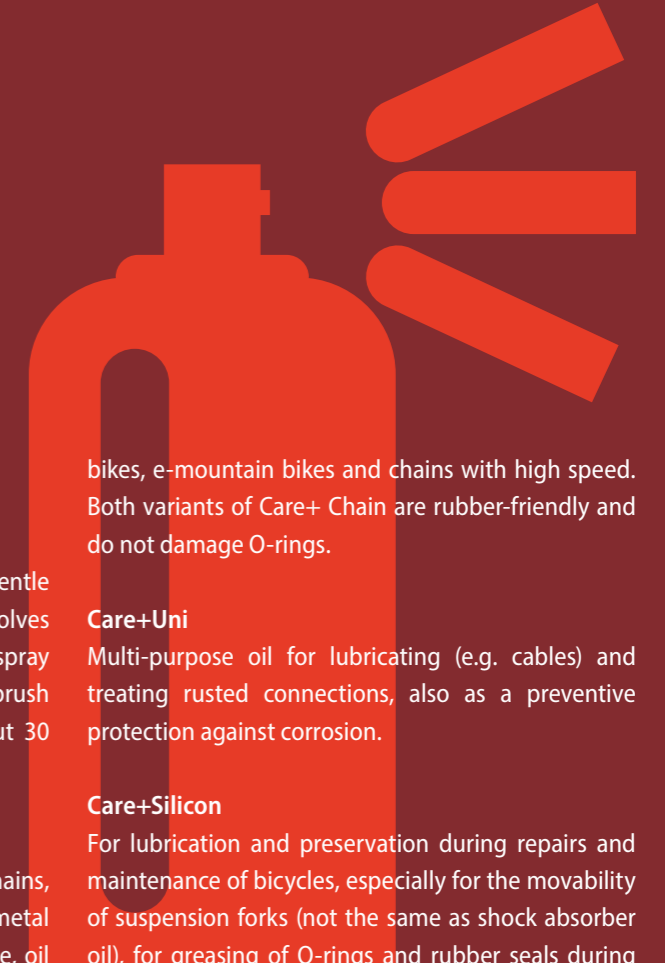

### CLEANING

#### Care+Clean

Our cleaning agent for your bike. Particularly gentle on paint and plastic parts, Care+ specifically dissolves typical bicycle dirt - from mud to grease. Simply spray on with the practical spray bottle, rub with a brush or cloth and rinse with clean water after about 30 seconds. Done!

#### Care+Fat

Strong degreaser for thorough cleaning of chains, brake discs, rims, bearings and other metal components. Only by spraying it removes grease, oil and brake fluid residues. Do not forget to relubricate movable parts such as chains and bearings.

### LUBRICATING

#### Care+Chain & Care+Extreme

Our high quality chain fluid grease is used for the lubrication of chains and sprockets. Thanks to its good flow behavior, it ensures lubrication even in narrow gaps. It displaces water, is resistant to water vapor and offers high corrosion protection. Despite its low adhesive content, it is throw-off resistant and therefore suitable for dusty environments. Care+ Chain Extreme contains a higher proportion of adhesive components compared to Care+ Chain and is therefore particularly well suited to extreme conditions with a lot of mud, wetness, snow and ice. It is perfect for use on mountain

bikes, e-mountain bikes and chains with high speed. Both variants of Care+ Chain are rubber-friendly and do not damage O-rings.

#### Care+Uni

Multi-purpose oil for lubricating (e.g. cables) and treating rusted connections, also as a preventive protection against corrosion.

#### Care+Silicon

For lubrication and preservation during repairs and maintenance of bicycles, especially for the movability of suspension forks (not the same as shock absorber oil), for greasing of O-rings and rubber seals during the assembly, as well cables, derailleur bolts.

### CARE

#### Care+Trim Shine

Perfect finish for your bike care! Care+ Trim Shine maintains and preserves all metal, plastic, rubber and synthetic leather and leather parts. It provides a color restoration and emits pleasant berry fragrance. Regular application extends the life-span of the treated parts.



**Care+ Trim Matt**  
Is a special developed cleaning and preserving agent for bike parts with a matt finish. Care+ Trim Matt protects metal, plastic, rubber, synthetic leather and leather parts. It refreshes the color and emits a pleasant fragrance. It restricts the re-setting of dust. A regular application extends the life-span of the treated parts.

**BODY CARE / CLEANING**

**Hands/Off**  
The bike is clean but your hands are not? We offer with the CONTEC Hands/ Off a skin-friendly cleaning agent for the hands. It removes typical workshop stains from the skin with a natural surfactant. First rub the dirty places with Hand/Off and then rinse them with water.

**MAINTENANCE**

Modern bike brake systems are mostly hydraulic brakes. The brake fluid serves as a strength transmitter from the brake lever to the brake piston. Brake fluids consist on a mineral oil base or glycol base (non-mineral). Regardless of the used fluid base, the brake fluid must be changed from time to time to ensure the full functionality of the braking system. In the case of non-mineral brake fluids, such as our Brake Prep D (DOT 4) and Brake Prep D+ (DOT 5.1), different DOT classes are specified which are used to determine the associated physical properties such as boiling point (liquid without water), wet point (brake fluid with 3,5% Water content), viscosity and cold viscosity.

Since non-mineral brake fluids attract water, over time it comes to an enrichment of the brake fluid with water from the ambient air. If the water content exceeds 3,5%, the brake fluid should be replaced because the boiling point has changed and the brake function is affected.

Brake Prep D is a DOT 4 brake fluid with a boiling point of at least 230°C and a wet boiling point of at least 155°C. Brake Prep D+ as a DOT 5.1 brake fluid has a boiling point of at least 260°C and a wet boiling point of 180°C.

We also offer a mineral brake fluid with Brake Prep O. It has a lower boiling point than our non-mineral brake fluid. The advantage of mineral brake fluid is that the brake properties remain for a long time constant because it does not absorb water.

<p>500g VOLUME</p>		<p><b>CARE+ HAND</b></p> <ul style="list-style-type: none"> <li>·skin-friendly and alkali-free hand cleanser</li> <li>·with natural surfactants to remove dirt from the skin</li> </ul> <hr/> <table border="0"> <tr> <td>0.356.941/5 500g can</td> <td>000995</td> </tr> </table>	0.356.941/5 500g can	000995			
0.356.941/5 500g can	000995						
<p>50ml VOLUME</p>	<p>0,2l VOLUME</p>		<p><b>CARE+ CHAIN</b></p> <ul style="list-style-type: none"> <li>·chain fluid grease (city / trekking)</li> </ul> <hr/> <table border="0"> <tr> <td>0.356.944/9 50ml dropping bottle</td> <td>000795</td> </tr> <tr> <td>0.356.926/6 200ml spray can</td> <td>001195</td> </tr> </table>	0.356.944/9 50ml dropping bottle	000795	0.356.926/6 200ml spray can	001195
0.356.944/9 50ml dropping bottle	000795						
0.356.926/6 200ml spray can	001195						
<p>50ml VOLUME</p>	<p>0,2l VOLUME</p>		<p><b>CARE+ CHAIN MTB</b></p> <ul style="list-style-type: none"> <li>·chain fluid grease (MTB)</li> </ul> <hr/> <table border="0"> <tr> <td>0.356.933/2 50ml dropping bottle</td> <td>000795</td> </tr> <tr> <td>0.356.927/4 200ml spray can</td> <td>001195</td> </tr> </table>	0.356.933/2 50ml dropping bottle	000795	0.356.927/4 200ml spray can	001195
0.356.933/2 50ml dropping bottle	000795						
0.356.927/4 200ml spray can	001195						
<p>0,2l VOLUME</p>		<p><b>CARE+ UNI</b></p> <ul style="list-style-type: none"> <li>·multi-purpose oil</li> </ul> <hr/> <table border="0"> <tr> <td>0.356.928/2 200ml spray can</td> <td>000795</td> </tr> </table>	0.356.928/2 200ml spray can	000795			
0.356.928/2 200ml spray can	000795						





**CARE+ SILICONE**

·silicone spray

0.356.929/0 200ml spray can 000795



**CARE+ DEGREASE**

·degreaser

0.356.930/8 200ml spray can 000795



**CARE+ CLEAN**

·bike cleaner

0.356.945/6 500ml spray bottle 000895

0.356.946/4 1l bottle 001095

0.356.947/2 5l canister 003995



**CLEAN DELUXE**

·bike cleaner

0.356.922/5 500ml spray bottle 000895



**CARE+ TRIM MATT**

·cleaning and preserving agent for bicycle parts with a matt finish  
·refreshes colors

0.356.940/7 200ml spray can 000795



**CARE+ TRIM SHINE**

·care spray

0.356.931/6 200ml spray can 000795



**CARE+ BRAKE PREP D**

·DOT 4 brake fluid  
·for hydraulic brake systems

0.356.934/0 100ml dropping bottle 000595

0.356.935/7 1l bottle 000595



**BRAKE PREP D**

·DOT 4 brake fluid  
·for hydraulic brake systems

0.356.912/6 100ml dropping bottle 000595



**BRAKE PREP D+**

·DOT 5.1 brake fluid  
·for hydraulic brake systems

0.356.914/2 100ml dropping bottle	000795
0.356.915/9 1l bottle	002595



**CARE+ BRAKE PREP D+**

·DOT 5.1 brake fluid  
·for hydraulic brake systems

0.356.936/5 100ml dropping bottle	000795
0.356.937/3 1l bottle	002595



**CARE+ BRAKE PREP O**

·mineral brake fluid  
·for hydraulic brake systems

0.356.938/1 100ml dropping bottle	000595
0.356.939/9 1l bottle	001795



**CARE+ GREASE**

·bearing grease

0.356.932/4 100g tube	000495
-----------------------	--------

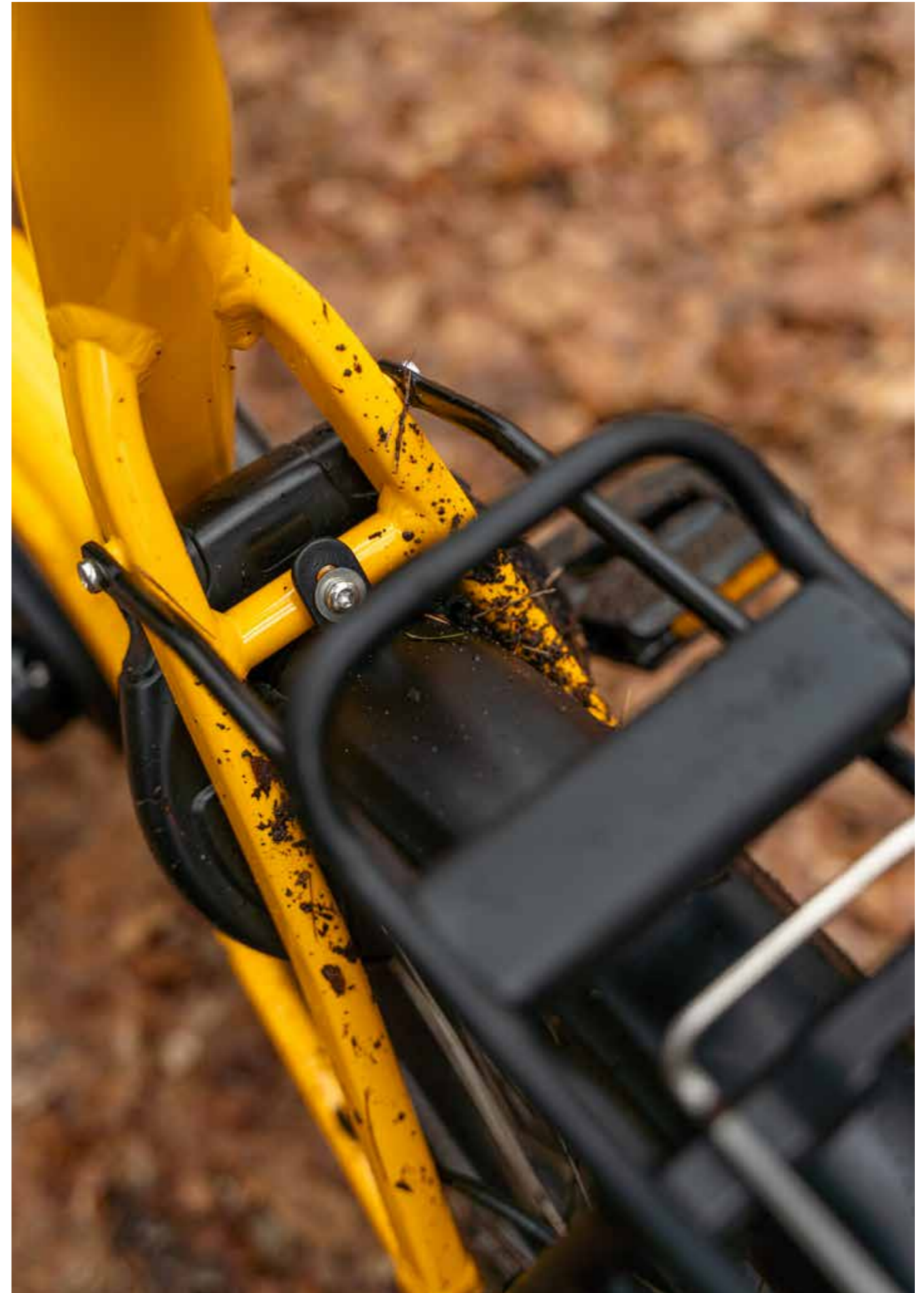



**ANTIPLATT**

- puncture protection placed between tire and tube
- self adjusting

0.353.923/6 for 19 / 23 x 622, 19mm wide, yellow	001195
0.353.924/4 for 25 / 28 x 622, 25mm wide, red	001195
0.353.925/1 for 32 / 35 x 590; 32 / 35 x 622 and 25 / 35 x 630, 31mm wide, blue	001195
0.353.926/9 for 37 / 47 x 622, 37mm wide, green	001195
0.353.927/7 for 37-54 x 559, 39mm wide, orange	001195



**HOT PATCH**

- repair patch box for all tubes
- 6 self-adhesive patches Ø 25mm, 1 sand paper
- very elastic texture, fast and easy

0.355.900/2 single package	000395
0.355.902/8 box with 100 sets	039595



**PATCH.IT PRO**

- 6x patches
- 9x repair plates
- special glue
- sandpaper
- 3x tire lever
- AV adapter
- SV adapter

0.355.925/9 self-service package	000795
----------------------------------	--------



**PATCH.IT**

- 6x patches
- repair plate
- special glue
- sandpaper
- tire lever

0.355.924/2 self-service package	000595
----------------------------------	--------



**CARE+ SEAL**

- tire sealant for tubeless tires
- seals holes up to 6mm

0.356.942/3 125ml dropping bottle	000995
0.356.943/1 1l bottle	002795







## TUBELESS

### Tubeless valves

Tubeless tires offer many advantages from which you can benefit as a MTB, gravel or road bike rider equally: low rolling resistance, greater puncture resistance and thus the possibility of riding with low air pressure to achieve more grip or more comfort. But until now tubeless tires were often difficult to install and maintain, which may have kept you from changing to tubeless riding.

With our FastAir TL valves, we have proclaimed the struggle against the cumbersome installation of tubeless tires: Instead of an electric compressor, you only need a floor pump, such as our Air Support Sport, to mount the tubeless tire on the rim. Using our

injector kit, you can not only easily fill in sealant, but also pump it out without making a mess and without clogging the valve. Above all, this step is done quickly, so that this can be done effortlessly before or after every ride.

With our latest version FastAir TL II is now possible for you to use tire inserts. Due to the modified base, the inserts can not block the valve and enough air gets into the tire.



FASTAIR TL II MTB P.340



CARE + SEAL (125ML) P.343





NEW



**FASTAIR TL II MTB**

- tubeless valve for MTB
- with 300% more air flow than Sclaverand valve
- tubeless tires can be mounted without compressor or tire booster
- ideal for use with CT Seal Prep sealant and injector kit
- aluminium with rubber cap

0.330.036/6 S, 13,5 - 21,5mm	002995
0.330.037/4 M, 21,5 - 29,5mm	002995
0.330.038/2 L, 29,5 - 37mm	002995



**FASTAIR TL MTB**

- for MTB
- tubeless tires can be mounted without compressor or tire booster
- suitable for Schrader 8mm, with rubber cap
- ideal for use with CT Seal Prep sealant and injector kit

0.330.036/5 "S", for rim depth 13,5 - 21,5mm, total length: 68mm	002795
0.330.037/3 "M", for rim depth 21,5 - 29,5mm, total length: 78mm	002995
0.330.038/1 "L", for rim depth 29,5 - 37,5mm, total length: 98mm	003195



**FASTAIR TL MTB**

- tubeless valve for conversion of conventional tubeless valves
- tubeless tires can be mounted without compressor or tire booster
- suitable for Schrader 8mm with rubber cap
- ideal for use with CT Seal Prep sealant and injector kit

0.330.039/9 black	001995
-------------------	--------

NEW



**FASTAIR TL II ROAD**

- tubeless valve to convert conventional tubeless valves
- tubeless tires can be mounted without compressor or tire booster
- fits Presta 6mm with rubber cap
- ideal for use with CT Seal Prep sealant and injector kit

0.330.040/8 40mm	002995
0.330.041/6 50mm	002995
0.330.042/4 65mm	002995



**FASTAIR TL ROAD**

- tubeless Valve for road
- for road
- tubeless tires can be mounted without compressor or tire booster
- suitable for 6mm rim hole (Presta), with rubber cap
- ideal for use with CT Seal Prep sealant and injector kit

0.330.040/7 for rim depth up to 40mm, total length: 68mm	002895
0.330.041/5 for rim depth up to 50mm, total length: 78mm	002995
0.330.042/3 for rim depth up to 60mm, total length: 93mm	003095



**FASTAIR TL ROAD**

- Tubeless Valve FastAir TL Road Convertor
- for conversion of conventional tubeless valves
- tubeless tires can be mounted without compressor or tire booster
- suitable for Presta 6mm with rubber cap
- ideal for use with CT Seal Prep sealant and injector kit

0.330.043/1 black	000695
-------------------	--------



**FASTAIR TL ROAD EXTENSION**

- tubeless valve extension with alloy
- tubeless tire can be mounted without compressor or tire booster
- suitable for Sclaverand valve 6mm with rubber cap
- associated CT Sealprep sealant and injector

0.330.044/9 30mm	001995
0.330.045/6 50mm	001995

NEW



**FASTAIR TL ROAD**

- valve adapter for use with floor pumps and hand pumps, in conjunction with FASTAIR valves

0.331.043/1 6mm Sclaverand	000695
----------------------------	--------



**STINGER TL PRO**

- complete repair set for tubeless tires
- CNC-machined aluminium housing
- cleaning- and insertion tool
- incl. 10 rubber strips
- length: 87mm, 69g

0.355.922/6 black	002495
-------------------	--------



**RUBBER STRIPS**

- universal repair rubbers for tubeless tires
- 10 pieces, various diameters
- refill set for "Stinger TL Pro" (0.355.922/6)
- length: 50mm

0.355.923/4 red / black	000595
-------------------------	--------



**TUBELESS SEAL PREP INJECTOR KIT**

- injector set for CONTEC FastAir tubeless valve
- clean and precise filling of tubeless sealant
- multiple use after cleaning
- 1x 60cc syringe, 1x 6mm tube

0.356.925/8 transparent	000995
-------------------------	--------



**CARE+ SEAL**

- tire sealant for tubeless tires
- seals holes up to 6mm

0.356.942/3 125ml dropping bottle	000995
0.356.943/1 1l bottle	002795



**TUBELESS SEAL TAPE TL**

- self-adhesive tubeless rim tape for mounting tubeless tires
- sufficient for four (29"/28") up to five (27,5"/26") rims
- thickness: 0,12mm, length: 10mm
- glossy black

0.853.609/6 19mm wide	000995
0.853.610/4 21mm wide	000995
0.853.611/2 23mm wide	000995
0.853.612/0 25mm wide	000995
0.853.613/8 27mm wide	001195
0.853.614/6 29 mm wide	001195
0.853.615/3 30mm wide	001195





## TOOLS

# Well prepared



With our new tool line TFP („Tools for Professionals“), we are raising the bar for affordable tools at a professional level. No matter if you are an ambitious occasional mechanic or a professional - we offer you excellent tools that are fun to use at any experience level. With special tools for crank, pedals / bottom brackets, chains / sprockets, headsets / forks, spokes / tires and hubs, we cover the entire needs of a professional. Now newly expanded with locking tools for various e-bike drives from Bosch, Brose or Shimano.

On the way, great versatility and low weight are important, because nobody wants to carry a complete set of keys uphill in a jersey pocket. Our TFR („Tools for Ride“) tools are therefore specially designed for mobile

use and will not let you go unprepared for your ride. Whether adjusting the rear derailleur or brake, tightening screws or adjusting the saddle height. Our Tools for Ride offer the most important tools for a relaxed trip.

With our TFM („Tools for Mechanics“) collection, we offer a basic range of the most important bicycle tools. These tools can be used to make the most necessary settings and maintenance work on your bike.



TFM MATCH P.351



TFP 400E P.349



**TFP-210**

- T25, T30 und T40 star wrench
- steel
- ergonomic handle

0.370.638/9 black 000995



**TFP-230**

- Y-socket wrench, 8, 10 and 13mm
- steel
- ergonomic grip

0.370.640/5 black 001195



**TFP-220**

- 4, 5 and 6mm inside hexagon wrench
- steel
- ergonomic handle

0.370.639/7 black 000995



**TFP-200**

- inside hexagone wrench
- use as T- and L-key
- steel
- ergonomic handle

0.370.632/2 3mm 000795  
 0.370.633/0 4mm 000795  
 0.370.634/8 5mm 000795  
 0.370.635/5 6mm 000795  
 0.370.636/3 8mm 000995



**TFP-150**

- cone wrench
- steel
- ergonomic handle

0.370.621/5 13mm 000995  
 0.370.622/3 14mm 000995  
 0.370.623/1 15mm 000995  
 0.370.624/9 16mm 000995  
 0.370.625/6 17mm 000995



**TFP-150 SET**

- cone wrench set
- consisting of: 13,14, 15, 16 and 17mm
- steel
- ergonomic handle

0.370.626/4 black 003995



**TFP-190**

- wheel nut tool
- ring wrench for 14 and 15mm
- ideal for city and trekking wheels
- steel
- ergonomic handle

0.370.631/4 black 001595



**TFP-120**

- socket wrench, rigid, for 1/2" sockets
- steel
- ergonomic handle

0.370.618/1 black 002495

**TFP-130**

- crank remover
- for assembly / disassembly of cranks with external bearings such as: Hollowtech II, Truvativ, FSA Magaexo and Campagnolo Ultra Torque, incl. 2 adapters 1x for Shimano SM-BB9000 / BB93, 1x SM-BBR60
- steel
- ergonomic handle

0.370.619/9 black 002995

**TFP-180**

- pedal wrench
- double-sided wrench for quick assembly / disassembly
- steel
- ergonomic handle

0.370.630/6 black 002495

**TFP-140**

- bottom bracket remover
- for assembly / disassembly of bottom brackets with external bearings such as: Hollowtech II, Truvativ, FSA Magaexo and Campagnolo Ultra Torque, incl. 2 adapters 1x for Shimano SM-BB9000 / BB93, 1x SM-BBR60
- steel
- ergonomic handle

0.370.620/7 black 003495

**TFP-160**

- bottom bracket remover
- suitable for most lock ring sizes
- steel
- ergonomic handle

0.370.628/0 black 001595

**TFP-170**

- bottom bracket remover
- for assembly / disassembly of Octalink or ISIS drive
- steel
- ergonomic handle

0.370.629/8 black 002995

**TFP-100**

- chain whip
- chain suitable for 5 -11-speed sprockets
- steel
- ergonomic handle

0.370.616/5 black 002595

**TFP-110**

- locking tool for HG cassettes and Center Lock rotors
- steel
- ergonomic handle

0.370.617/3 black 002295

**NEW****TFP-400E**

- remover
- for mounting or dismounting the spider lockring and chain ring
- for 1/2" socket
- CNC milled with silicone O-ring

0.370.601/0 suitable for Bosch Gen.2 Active / Performance / CX Line (from mod. 2014) 002995

**NEW****TFP-410E**

- remover
- for mounting or dismounting the spider lockring and chain ring
- for 1/2" socket
- CNC milled with silicone O-ring

0.370.601/1 suitable for Bosch Gen. 3 ActiveLine (from mod. 2018), Active Line Plus, Brose 002995

Bosch Gen. 4 Performance Line, Performance Line CX, Cargo Line

**NEW****TFP-420E**

- remover
- for mounting or dismounting the spider lockring and chain ring
- for 1/2" socket
- CNC milled with silicone O-ring

0.370.601/2 suitable for Shimano E8000, E7000, E6100 002995



NEW

**TFP-430E**

- remover
- for mounting or dismounting the spider lockring and chain ring
- for 1/2" socket
- CNC milled with silicone O-ring

0.370.601/3 suitable for Bosch Gen.1 (mod. 2010-2013) Classic Line, Classic+ 003295

NEW

**TFP-447**

- bottom bracket remover
- suitable for all T47 bottom brackets
- for 1/2" socket wrench
- dual-sided design
- 16 teeth / 52,2mm outer diameter for Enduro / Press Fit 30 Standard
- 12 teeth / 50,4mm outer diameter for Chris King Thread Fit / Thread Fit 30 Standard

0.370.601/4 for enduro T47 & PF30 / Chris King Thread Fit T47 & Thread Fit 30 003995

NEW

**TFP-SHARK**

- multitool with 9 functions
- mounting and dismounting of Center Lock brake discs
- measuring the wear limit
- 5mm hexagonal wrench extension
- straightening tool for brake discs
- pushing back brake pistons

0.370.640/6 black 002995

NEW

**TFP-INSERT**

- for pressing line nipples (pins) and banjo connectors into the brake line
- suitable for all common manufacturers such as: Avid / Sram, Hayes, Magura (except HS11 and HS33), Shimano, Tektro

0.370.640/7 silver 005995

NEW

**TFP-TTS**

- measuring cone
- to determine the seat post diameter, simply drop the measuring cone into the seat tube of the frame
- measuring range from Ø 25,0mm up to Ø 34,9mm

0.370.945/7 grey 001995

**TFM-350**

- torque wrench
- chrome-vanadium
- drive: 1/4"
- 9 pieces bit set (3/4/5/6/8/10 inside hexagon wrench, star T25 / T30, extension)
- especially suitable for carbon components

0.370.945/8 2-24Nm 008495

NEW

**TFM-TORCH**

- torque wrench
- with ratchet head
- chrome-vanadium
- 1/4" drive
- 9 bits (3/4/5/6/8/10mm inside hexagon, T20/T25/T30 star) and 5mm extension
- especially well suited for carbon parts

0.370.945/9 2-20 Nm 007995

NEW

**TFM-MATCH**

- torque wrench
- with ratchet head
- 148mm long
- aluminium
- 1/4" drive
- 10 bits (2/3/4/5/6/8mm inside hexagon, T25/T30 star, slotted and Phillips screwdriver), 6mm extension
- small design

0.370.945/6 2-14 Nm 006995

**TFM-100**

- Bowden cable stretcher
- one-hand operation
- rubberized handle

0.370.009/3 lockable 001995



**TFM-CUT+**

- cable pliers
- for inner cables and outer casing
- ergonomic handle

0.370.978/9 black

002995

**TFM 110**

- cable cutter
- for cables, cable covers and spokes
- rubberized handle

0.370.014/3 150mm grip length

001995

**TFM-250**

- inside hexagon key set
- 8 pieces set, with a bracket for wall mounting
- to use as T- and L-key
- ergonomic grip
- with ball end

0.370.923/5 2/2,5/3/4/5/6/8/10mm

004695

**TFM-260**

- inside hexagon key set
- 7 pieces set, in plastic bracket
- to use as a T- and L-key
- with ball end

0.370.924/3 2,5/3/4/5/6/8/10mm

001795

**TFM-EZ DUTCH**

- chainstay spreader
- allows changing the tube on the bike with a closed chain case, without dismantling them

0.370.969/8 black

001695

**TFM-280**

- cone spanner
- set with 2 pieces

0.370.930/0 13/14 and 15/16mm

000995

**TFM-270**

- ratchet wrench
- chrome-vanadium

0.370.926/8 8mm

001595

0.370.927/6 10mm

001595

0.370.928/4 13mm

001695

0.370.929/2 15mm

001895

**TFM-330**

- tool case
- with all important tools for maintenance and repair on bike
- content:
  - 1 spoke wrench
  - 3 nut driver 8/9/10mm
  - 4 screw driver bits; 2 Phillips-/ 2 slot
  - 1 L-key for the use of different tool parts and bits
  - 1 inside hexagon key 8mm, incl. 1/2" square adapter, grip length 200mm
  - 1 crank extractor for 4-square cranks
  - 1 cone wrench set with 2 pieces, 13/14 and 15/16mm
  - 1 open-end spanner 8/10mm
  - 1 tire lever set with 3 pieces, plastic
  - 1 monkey wrench
  - 1 pin wrench, adjustable
  - 1 inside hexagon key set 2/2,5/3/4/5/6mm
  - 1 C-spanner
  - 1 chain whip
  - 1 straight blade screw driver
  - 1 air pressure gauge for Schrader valve
  - 1 head set wrench 30/32 and 36/40mm
  - 1 Shimano cassette removal sprocket, 1/2" drive
  - 1 bottom bracket tool, 1/2" drive
  - 1 patch set
  - 1 chain rivet extractor
  - 1 pedal wrench 15/16 and 15/17mm

0.370.015/0 36 pieces

008995



**TFM-120**

- crank remover
- 14mm socket, 6 / 8mm inside hexagon and 15mm spanner
- rubberized handle

0.370.016/8 110mm grip length 001495



**TFM-130**

- crank remover
- for crank screw connections
- rubberized grip

0.370.017/6 with 14/15mm socket and 15mm spanner 001495



**TFM-170**

- crank remover
- suitable for square
- with 14mm socket

0.370.024/2 hardened steel 001095



**TFM-240**

- crank remover
- suitable for square taper, Octalink and ISIS drive

0.370.920/1 hardened steel 000995



**TFM-140**

- pedal wrench
- grip length: 250mm
- rubberized handle

0.370.018/4 15mm 000995



**TFM-310**

- press out tool
- for Pressfit bottom brackets

0.370.968/0 suitable for BB30, BB86, BB90 004495



**TFM-300**

- press-in tool
- for Pressfit bottom brackets

0.370.967/2 suitable for BB30, BB86, BB90 004495



**TFM-220**

- bottom bracket remover
- suitable for JIS, Octalink and ISIS drive
- suitable for 1/2" drive and 24mm wrench

0.370.907/8 hardened steel 001595



**TFM PIN PUSHER**

- chain tool
- workshop quality
- black

0.370.918/5 Club, for Shimano 7-/8-/9-/10-speed, IG/UG/HG-chains, incl. spare pin	001995
---	--------

0.370.919/3 World Cup, for all chains, incl. spare pin and spare counterholder	003295
--	--------

**TFM PIN PUSHER POCKET**

- chain tool
- compact pocket version in workshop quality

0.370.917/7 for Shimano UG/HG-chains	001595
--------------------------------------	--------

**TFM-320**

- chain link pliers
- to open and lock of chain connecting links

0.370.973/0 black	001495
-------------------	--------

**TFM-CHARLIE TANGO**

- chain wear indicator

0.370.959/9 analog	000995
--------------------	--------

**TFM-180**

- chain tool
- standard version

0.370.903/7 for all current chain types	000995
---	--------

**TFM-190**

- cassette remover
- for Shimano cassette sprockets
- suitable for 1/2" drive and 21mm wrench

0.370.904/5 hardened steel	000995
----------------------------	--------

**TFM-200**

- cassette remover
- for cassette sprockets
- suitable for 1/2" drive and 21mm wrench

0.370.905/2 hardened steel	000995
----------------------------	--------

**TFM-210**

- cassette remover
- for BMX-freewheel cassettes
- suitable for 24mm wrench

0.370.906/0 hardened steel	000995
----------------------------	--------

**TFM-290**

- cassette remover
- for HG cassettes
- with guide pin
- suitable for 24mm wrench

0.370.941/7 hardened steel	001095
----------------------------	--------

**TFM-150**

- chain whip
- with chain for up to 9-speed cassettes

0.370.019/2 rubberized grip	000995
-----------------------------	--------

**TFM-HEAD BANGER**

·cup extractor for headset shells

0.370.970/6 1", Ø 25,4mm	002195
0.370.971/4 1 1/8", Ø 25,4mm	002195
0.370.972/2 1,5", Ø 28,6mm	002195

**TFM-NUT KNOCKER**

·inserter for headset star (ahead-clamp)

0.370.976/3 1 1/8", Ø 28,6mm	001595
------------------------------	--------

**TFM-CROWN CHISEL**

·fitting tool for fork cone

0.370.974/8 1", 1 1/8", 1,5" tapered (Ø 25,4mm, 28,6mm, 38,1mm double butted)	004995
---	--------

**TFM-ROUNDHOUSE CUT**

·tube cutter in a pro version  
·for 6-38mm (1/4", 1", 1 1/8", 1,5")

0.370.966/4 incl. spare blades and rotating deburrer	007495
0.370.979/7 spare blade	001495

**TFM-160**

·headset wrench  
·universal use

0.370.023/4 30/32 / 36/40mm	001495
-----------------------------	--------

**TFM-230**

·forged spoke spanner  
·8 cuts

0.370.915/1 9G - 15G	000595
----------------------	--------

**TFM-SPEED SHANK**

·tire lever in counter display  
·plastic  
·colour sorted

0.370.910/2 content: 30 sets tire levers with 3 pieces	011895
--	--------

**TFM-SPEED SHANK**

·tire lever  
·set with 3 pieces  
·plastic

0.370.916/9 black	000395
-------------------	--------



## Find your Treasure

NEW

### TREASURE FORK

- integrated multitool with 10 functions
- tool Ø 26,2 x 147mm long
- storage tube Ø 32 x 149mm long
- suitable for all 1 1/8" and tapered steerer tubes
- easy and quick removal of the minitool by twisting it out from the storage tube
- 1 = chain riveter
- 2 = 2x tire lever
- 3 = 6mm inside hexagon key
- 4 = 4mm inside hexagon key
- 5 = 5mm inside hexagon key
- 6 = 3mm inside hexagon key
- 7 = T25 inside hexagon key
- 8 = slotted screwdriver
- 9 = 2x chain spare pins
- 10 = ratchet head

0.370.946/0 black / silver

007995



NEW



### TREASURE BAR DLX

- integrated multitool with 12 functions
- 128mm long
- suitable for all handlebar inner diameters, individually adjustable by different O-rings
- 1 = 5mm inside hexagon key
- 2 = 2,5mm inside hexagon key
- 3 = 3mm inside hexagon key
- 4 = 2mm inside hexagon key
- 5 = 4mm inside hexagon key
- 6 = tire lever
- 7 = 6mm inside hexagon key
- 8 = T30 star key
- 9 = T10 star key
- 10 = T25 star key
- 11 = Phillips screwdriver
- 12 = slotted screwdriver

0.370.946/1 black / silver

004595

NEW



### TREASURE BAR TL

- integrated tubeless tool
- 84mm long
- suitable for all handlebar inner diameters, individually adjustable by different O-rings
- with insertion tool and space for repair rubbers (suitable refill set 0.355.923/4)

0.370.946/2 black

002495

NEW



### TREASURE BAR ECO

- integrated tire lever
- 117mm long
- suitable for all handlebar inner diameters, individually adjustable due to different O-rings
- with 2 tire levers incl. practical recess for fixing to a spoke

0.370.946/3 black

001995

## Innovation through integration.

At CONTEC we are always trying to improve your cycling experience. Our latest innovation is the Treasure minitool series: With these multitools you can integrate the most important tools inconspicuously and hidden in almost every (e-)bike. This way, you always have your tools at hand without loading or filling your pockets. This allows you to be carefree on the road, both mentally and back.

The Treasure series includes four different tools: The first is the Treasure Fork Minitool, which is sunk into the head tube of your fork. Once you take it out, it reveals a compact workshop with a mini-ratchet, six different

bits, an integrated chain riveter and tire levers. The three different Treasure Bar Tools are placed in the ends of your handlebars and offer tire levers, tubeless tools or 12 more bits with a socket wrench, depending on the variant. This allows you to equip your bike with the tools individually according to your needs, either individually or in combination.

Should you ever need this treasure, you can be sure that it is worth more to you than gold and money.



**TFR - MICRO RATCHET SMART**

- socket spanner ratchet with reversible function for 1/4"
- 2 bit adapters
- incl. 6 bits (Hex 4 / 5 / 6 / T25 / T30 / PH2)
- storage in robust aluminium sleeve

0.370.986/2 silver / black

003995

**TFR - TRIDENT RATCHET**

- socket spanner ratchet with reversible function for 1/4"
- can be used as T-tool
- incl. extension and 10 bits (Hex 2.5 / 3 / 4 / 5 / 6 / 8 / T25 / T30 / PH1)
- CrV-tool steel

0.370.985/4 silver

003995

**TFR - RELOAD**

- 6 replaceable bits
- bit storage in grip
- pivoted tool head to use as L-grip
- aluminium / CrMo-steel
- length: 120mm, 75g

0.370.987/0 black

002995

NEW

**TFR - STRIKER 16**

- multitool with 16 functions:
- 1 = 3mm inside hexagon key
- 2 = 5mm inside hexagon key
- 3 = 8mm inside hexagon key
- 4 = 2,5mm inside hexagon key
- 5 = Phillips screwdriver
- 6 = chain riveter
- 7 = 3,23mm spoke wrench
- 8 = 3,3mm spoke wrench
- 9 = 3,45mm spoke wrench
- 10 = 3,96mm spoke wrench
- 11 = 8mm open-end wrench
- 12 = 10mm open-end wrench
- 13 = 4mm inside hexagon key
- 14 = T30 star key
- 15 = T25 star key
- 16 = 6mm inside hexagon key

0.370.945/5 silver

003495

NEW

**TFR - BUSTER 9**

- multitool with 9 function:
- 1 = T30 star key
- 2 = T25 star key
- 3 = 3mm inside hexagon key
- 4 = 4mm inside hexagon key
- 5 = 2,5mm inside hexagon key
- 6 = 6mm inside hexagon key
- 7 = 2mm inside hexagon key
- 8 = 5mm inside hexagon key
- 9 = 8mm inside hexagon key

0.370.945/4 silver

002495

**TFR - FOLD 8**

- multitool with 8 functions:
- 1 = 5mm inside hexagon key
- 2 = 4mm inside hexagon key
- 3 = 3mm inside hexagon key
- 4 = 2,5mm inside hexagon key
- 5 = 6mm inside hexagon key
- 6 = T30 star key
- 7 = T25 star key
- 8 = Phillips screwdriver

0.370.990/4 silver

003495

**TFR - FOLD 6**

- multitool with 6 functions:
- 1 = Phillips screwdriver
- 2 = T25 star key
- 3 = T30 star key
- 4 = 4mm inside hexagon key
- 5 = 5mm inside hexagon key
- 6 = 6mm inside hexagon key

0.370.989/6 silver

002995

**TFR - FOLD 4**

- multitool with 4 functions:
- 1 = 5mm inside hexagon key
- 2 = 6mm inside hexagon key
- 3 = Phillips screwdriver
- 4 = 4mm inside hexagon key

0.370.988/8 silver

002495

**POCKET GADGET - F22 STEALTH**

- multitool with 22 functions:
- 1 = chain riveter
- 2 = 10mm open-end wrench
- 3 = brake piston spreader
- 4 = bottle opener
- 5 = 3,2mm spoke wrench
- 6 = 3,5mm spoke wrench
- 7 = 5,65mm spoke wrench
- 8 = 4mm slotted screwdriver
- 9 = 2mm Phillips screwdriver
- 10 = 5mm inside hexagon key
- 11 = 6mm inside hexagon key
- 12 = T40 star key
- 13 = 2mm inside hexagon key
- 14 = 2,5mm inside hexagon key
- 15 = 3mm inside hexagon key
- 16 = 4mm inside hexagon key
- 17 = T25 star key
- 18 = T27 star key
- 19 = T30 star key
- 20 = 3mm slotted screwdriver
- 21 = 1mm Phillips screwdriver
- 22 = 8mm inside hexagon key

0.370.977/1 black

003495

**POCKET GADGET - PG1**

- multitool with 8 functions:
- 1 = T25 star key
- 2 = 4mm inside hexagon key
- 3 = Phillips screwdriver
- 4 = 3mm inside hexagon key
- 5 = slotted screwdriver
- 6 = 5mm inside hexagon key
- 7 = 6mm inside hexagon key
- 8 = chain riveter

0.370.955/7 black

002495

**TOOL 15**

- multitool with 15 functions
- 1 = 2mm inside hexagon key
- 2 = 2,5mm inside hexagon key
- 3 = 4mm inside hexagon key
- 4 = Phillips screwdriver
- 5 = slotted screwdriver
- 6 = 6mm inside hexagon key
- 7 = 5mm inside hexagon key
- 8 = chain riveter
- 9 = 3mm inside hexagon key
- 10 = bottle opener
- 11 = 9mm wrench
- 12 = 8mm wrench
- 13 = 10mm wrench
- 14 = 8mm wrench
- 15 = tire lever

0.370.938/3 black / silver

001795

**TOOL 9**

- multitool with 9 functions:
- 1 = Phillips screwdriver
- 2 = slotted screwdriver
- 3 = 5mm inside hexagon key
- 4 = 3mm inside hexagon key
- 5 = 4mm inside hexagon key
- 6 = 2,5mm inside hexagon key
- 7 = 6mm inside hexagon key
- 8 = 8mm inside hexagon key
- 9 = 2mm inside hexagon key

0.370.939/1 black / silver

001295

**MICRO GADGET - MG1**

- multitool with 4 functions:
- 1 = T25 star key
- 2 = 5mm inside hexagon key
- 3 = 6mm inside hexagon key
- 4 = 4mm inside hexagon key

0.370.957/3 black / silver

001295



**WALL RIDE**

- wall mounting bracket
- load-bearing elements in composite of steel and plastic
- 360° rotatable workpiece
- quick and easy one hand lever clamping

0.370.952/4 black

009995

**TABLETOP**

- mounting bracket for workbench mount
- load-bearing elements in composite of steel and plastic
- 360° rotatable workpiece
- quick and easy one hand lever clamping

0.370.953/2 black

009995

**ROCK STEWARD**

- foldable tray
- for mounting stand "Rock Steady"

0.370.958/1 black

001495

**FIDDLE CASE**

- padded nylon case for mounting stand "Rock Steady" for safety transport
- with larger opening and adjustable carrying straps
- additional compression strap and bag for small tools

0.370.951/6 black

003495

# Rock Steady meets Rock Steward



The duo for the home workshop: foldable, mobile stand Rock Steady from light aluminium and robust plastic easily handles every bike up to a weight of 25kg. The easy-to-use, one-hand clamp and 360° rotatable workpiece combined with rock-solid stability make maintenance and assembly work with Rock

Steady very simple. The home workshop is even more efficient thanks to Rock Steward foldable tool tray on which the most important tools have place and are quickly in hand. Rock Steady and Rock Steward can be easily stored after use in the CONTEC fiddle case.

**ROCK STEADY**

- foldable mobile workstand
- load-bearing elements in composite of lightweight aluminium and plastic
- 360° rotatable workpiece
- quick and easy one hand lever clamping

0.370.949/0 black

014995

**ROCK WHEEL**

- foldable
- suitable for 20"-28" wheels
- self-centering
- simultaneous control of upstroke and lateral runout possible

0.370.596/9 silver / black

009995





**SIZE**

The icon describes the available sizes of the helmet models.



**WATER PROOF**

Waterproof for the ideal protection even in bad weather.



**REFLECTION**

This icon shows attached reflective stripes for better visibility in road traffic.



**KIDS**

Especially for children. Parts and accessories that feature design, size and color especially for the youngest cyclists.



# HELMETS



## Safety starts with your head

When cycling, you should feel completely comfortable and safe, whether on the way to work, on a joint tour with the family, or when you're riding down MTB trails. That's why you shouldn't make any compromises when choosing your bike helmet. In our helmet range you will find everything your head desires, from cool children's and youth helmets to chic city and all-round

helmets and sporty MTB helmets. How about the CONTEC Tuva helmet, for example? In addition to the stylish colors, the city helmet scores with a magnetic closure, so that a jamming of the skin is prevented. If it is a little sunnier while cycling, you can easily attach the removable fabric visor to the front of the helmet.



HELMET TUVA P.370



HELMET ROK P.372





**TUVA**

- light in-mold microshell plastic design
- Twist2Lock system for individual width adjustment
- Fidlock - magnetic chin lock
- 9 vents
- removable fabric visor
- approx. 305g

0.365.771/5 matt black, size S/M (52-58cm)	009995
0.365.772/3 matt black, size L (57-61cm)	009995
0.365.773/1 matt emerald green / mint green, size S/M (52-58cm)	009995
0.365.774/9 matt emerald green / mint green, size L (57-61cm)	009995
0.365.776/4 matt maritime blue / ocean, size L (57-61cm)	009995
0.365.777/2 matt wine red / strawberry, size S/M (52-58cm)	009995
0.365.778/0 matt wine red / strawberry, size L (57-61cm)	009995
0.365.779/8 matt white, size S/M (52-58cm)	009995
0.365.780/6 matt white, size L (57-61cm)	009995



**VENT**

- light in-mold microshell plastic construction
- Twist2Lock system for individual width adjustment
- Fit3Ride -3-step adjustment of the helmet to the driving dynamics
- Fidlock - magnetic chin lock
- 27 vents
- integrated insect screen
- approx. 310g

0.365.710/3 matt petrol blue / black, size M (54-58cm)	009995
0.365.712/9 matt white / white, size M (54-58cm)	009995
0.365.714/5 matt moss green / black, size M (54-58cm)	009995
0.365.715/2 matt moss green / black, size L (58-61cm)	009995

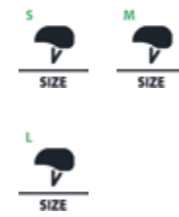

**CHILI**

- light in-mold microshell plastic construction
- Twist2Lock system for individual width adjustment
- Fidlock - magnetic chin lock
- 25 vents
- approx. 230g

0.365.718/6 matt petrol blue / black, size S (50-54cm)	006995
0.365.719/4 matt petrol blue / black, size M (54-58cm)	006995
0.365.721/0 matt white / black, size S (50-54cm)	006995
0.365.722/8 matt white / black, size M (54-58cm)	006995
0.365.723/6 matt white / black, size L (58-62 cm)	006995
0.365.724/4 matt safety yellow / black, size S (50-54cm)	006995
0.365.725/1 matt safety yellow / black, size M (54-58cm)	006995
0.365.726/9 matt safety yellow / black, size L (58-62cm)	006995
0.365.727/7 matt stone grey / black, size S (50-54cm)	006995
0.365.728/5 matt stone grey / black, size M (54-58cm)	006995
0.365.730/1 matt black / black, size S (50-54cm)	006995
0.365.731/9 matt black / black, size M (54-58cm)	006995
0.365.732/7 matt black / black, size L (58-62cm)	006995



**ROK**

- light in-mold microshell plastic design
- Twist2Lock system for individual width adjustment
- classic chin lock with strap pitch
- 19 vents
- approx. 270g

0.365.781/4 matt maple red / black, size M (55-59cm)	005995
0.365.783/0 matt sky blue / black, size M (55-59cm)	005995
0.365.784/8 matt sky blue / black, size L (58-61cm)	005995
0.365.785/5 matt black / black, size M (55-59cm)	005995
0.365.786/3 matt black / black, size L (58-61cm)	005995
0.365.787/1 matt desert sand / black, size M (55-59cm)	005995
0.365.788/9 matt desert sand / black, size L (58-61cm)	005995
0.365.789/7 matt safety yellow / black, size M (55-59cm)	005995
0.365.790/5 matt safety yellow / black, size L (58-61cm)	005995
0.365.791/3 matt clover green / black, size M (55-59cm)	005995
0.365.792/1 matt clover green / black, size L (58-61cm)	005995

**UNA**

- skate-look
- ABS hardshell plastic design
- Twist2Lock system for individual width adjustment
- classic chin lock and strap pitch
- 11 vents
- approx. 400g

0.365.733/5 matt white, size S (50-54cm)	004995
0.365.734/3 matt white, size M (54-58cm)	004995
0.365.735/0 matt white, size L (58-60cm)	004995
0.365.736/8 matt black, size S (50-54cm)	004995
0.365.737/6 matt black, size M (54-58cm)	004995
0.365.738/4 matt black, size L (58-60cm)	004995
0.365.739/2 matt sky blue, size S (50-54cm)	004995
0.365.740/0 matt sky blue, size M (54-58cm)	004995
0.365.741/8 matt sky blue, size L (58-60cm)	004995
0.365.742/6 matt wood green, size S (50-54cm)	004995
0.365.743/4 matt wood green, size M (54-58cm)	004995
0.365.744/2 matt wood green, size L (58-60cm)	004995







**JIMMYCANE**

- light out-mold microshell plastic construction
- Twist2Lock system for individual width adjustment
- classic buckle and strap division
- reflective elements
- 27 vents
- approx. 230g

0.365.755/8 matt black / stone grey, size S (52-56cm)	003995
0.365.757/4 matt stone grey / black, size S (52-56cm)	003995
0.365.758/2 matt stone grey / black, size M (56-58cm)	003995
0.365.760/8 matt sky blue / black, size M (56-58cm)	003995
0.365.761/6 matt clover green / black, size S (52-56cm)	003995



**JUNO**

- light out-mold microshell plastic design
- Twist2Lock system for individual width adjustment
- classic chin lock and strap pitch
- sun visor
- switchable safety flashing light on the rear side
- 10 vents
- approx. 200g

0.365.763/2 circus, rosé, size XS (48-52cm)	002995
0.365.764/0 circus, rosé, size S (52-56cm)	002995
0.365.765/7 circus, blue, size XS (48-52cm)	002995
0.365.766/5 circus, blue, size S (52-56cm)	002995
0.365.767/3 safety cat, safety yellow, size XS (48-52cm)	002995
0.365.768/1 safety cat, safety yellow, size S (52-56cm)	002995
0.365.769/9 galaxy, dark blue, size XS (48-52cm)	002995
0.365.770/7 galaxy, dark blue, size S (52-56cm)	002995



**SAFE R HEAD**

- suitable for bike helmets
- with elastic and cord closure
- waterproof

0.365.793/9 black / reflex	001495
0.365.795/4 safety yellow	001495







**SIZE**

The icon describes the available sizes of the different clothing.



**UNISEX**

Suitable for any personality.



**WATER PROOF**

Waterproof for the ideal protection even in bad weather.



**REFLECTION**

This icon shows attached reflective stripes for better visibility in road traffic.



**WINTER**

Protects from low temperatures.



**KIDS**

Especially for children. Parts and accessories that feature design, size and color especially for the youngest cyclists.



# CLOTHING



## Fashion that makes sense

Clothes make the man – or in this case, cyclists. Because the right clothing can be decisive in the question of comfort on the bike. In our collection you will find stylish shirts, sweaters and jackets as well as a lot of functional clothing. Our brand new summer gloves Crosso, Tripster, Pepper and Chili offer you additional grip and sufficient ventilation. For winter, you will find

a wide range of waterproof gloves at CONTEC, which will keep your hands warm enough in the cold. Do you already know our Red Line collection? The arm and leg warmers, as well as overshoes and caps equip you ideally for cycling and help you regulate your body temperature.



**BLEAK TOUCH SAFE R P.380**



**SMOOTH CRIMINAL P.384**

# Material

## Hipora membrane

Fine-pored fabric made of three layers. The first layer prevents the ingress of water, the second layer consists of a honeycomb structure and lets moisture through to the first layer so that it can evaporate. The third layer is closest to the skin and is very dense to provide additional protection against water ingress.

## Lycra

Elastic fabric with a high shape retention and low moisture absorption. Particularly light, smooth and soft textile fibers.

## Gel

High-tech silicone gel dampens pressure and vibrations to protect the carpal tunnel and to prevent rapid fatigue of the hands.

## DWR

Stands for „Durable Water Repellent“, permanently water repellent. Water drops have no hold on the surface due to the lotus effect and roll off. The membrane is breathable and effectively guides sweat and heat away from the body.

## Neopren

Due to air bubbles enclosed in the material, it is particularly heat-insulating. The material is also waterproof to provide high protection against rain and snow.

# Winter gloves

What was that again? There is no bad weather, only bad clothes! Even in winter it is wonderful to ride a bike. However, so that this does not lead to discomfort, winter gloves should be part of the standard equipment.

Cold affects the strength in the hands and thus on the grip on the handlebars. This can affect reaction time when shifting gears and braking – two impor-

tant functions that are crucial for your safety. With the gloves from CONTEC your hands stay warm, but do not restrict them in movement. So you have a free ride, no matter what the temperature!



## FRIGID TR

- water-proof Hi-Pora membrane
- touch-finger
- with reflective print on the upper hand for better visibility
- individual size adjustment by Velcro
- silicone print for good grip
- incl. ergonomic palm padding
- with terry thumbs to wipe sweat
- black / coolgrey

0.808.212/5 size S/7	003995
0.808.213/3 size M/8	003995
0.808.214/1 size L/9	003995
0.808.215/8 size XL/10	003995
0.808.216/6 size XXL/11	003995



## DENSE WATERPROOF

- water-proof Hi-Pora membrane
- silicone print for good grip
- neoprene wristles and softshell against cooling down
- with reflective print on the upper hand for better visibility
- with terry thumbs to wipe sweat

0.808.166/3 size S/7, black / coolgrey	003595
0.808.167/1 size M/8, black / coolgrey	003595
0.808.168/9 size L/9, black / coolgrey	003595
0.808.169/7 size XL/10, black / coolgrey	003595
0.808.170/5 size XXL/11, black / coolgrey	003595
0.808.171/3 size S/7, black / neoblue	003595
0.808.172/1 size M/8, black / neoblue	003595
0.808.173/9 size L/9, black / neoblue	003595
0.808.174/7 size XL/10, black / neoblue	003595
0.808.175/4 size XXL/11, black / neoblue	003595
0.808.176/2 size S/7, black / neogreen	003595
0.808.177/0 size M/8, black / neogreen	003595
0.808.178/8 size L/9, black / neogreen	003595
0.808.179/6 size XL/10, black / neogreen	003595
0.808.180/4 size XXL/11, black / neogreen	003595



## FREEZE WATERPROOF

- waterproof Hipora membrane
- neoprene wrist warmers
- optimal wind and weather protection
- with reflective print for good visibility
- individual size adjustment by Velcro
- incl. ergonomic palm padding
- with terry thumbs to wipe sweat
- black / coolgrey

0.808.202/6 size S/7	003295
0.808.203/4 size M/8	003295
0.808.204/2 size L/9	003295
0.808.205/9 size XL/10	003295
0.808.206/7 size XXL/11	003295



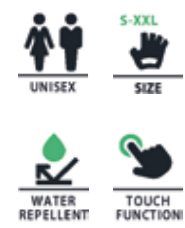

**BLEAK TOUCH**

- touch-finger
- silicone print for good grip
- neoprene wrist warmers
- incl. ergonomic palm padding
- terry thumbs to wipe sweat

0.808.181/2 size S/7, black / coolgrey	002795
0.808.182/0 size M/8, black / coolgrey	002795
0.808.183/8 size L/9, black / coolgrey	002795
0.808.184/6 size XL/10, black / coolgrey	002795
0.808.185/3 size XXL/11, black / coolgrey	002795
0.808.186/1 size S/7, black / neoblue	002795
0.808.187/9 size M/8, black / neoblue	002795
0.808.188/7 size L/9, black / neoblue	002795
0.808.189/5 size XL/10, black / neoblue	002795
0.808.190/3 size XXL/11, black / neoblue	002795
0.808.191/1 size S/7, black / neogreen	002795
0.808.192/9 size M/8, black / neogreen	002795
0.808.193/7 size L/9, black / neogreen	002795
0.808.194/5 size XL/10, black / neogreen	002795
0.808.195/2 size XXL/11, black / neogreen	002795



**BLEAK TOUCH SAFE R**

- touch finger
- silicone print for extra good grip
- neoprene wrist warmers
- incl. ergonomic palm padding
- terry thumb to wipe away sweat
- black / safety yellow

0.808.745/4 size S / 7	002495
0.808.746/2 size M / 8	002495
0.808.747/0 size L / 9	002495
0.808.748/8 size XL / 10	002495
0.808.749/6 size XXL / 11	002495



**FROST**

- silicone print for good grip
- incl. ergonomic palm padding
- terry thumbs to wipe sweat
- black / coolgrey

0.808.161/4 size S/7	002495
0.808.162/2 size M/8	002495
0.808.163/0 size L/9	002495
0.808.164/8 size XL/10	002495
0.808.165/5 size XXL/11	002495

# Summer gloves



Gloves in summer? That sounds like a strange combination at first. But who has ever taken a longer bike ride, especially on the mountain, gravel or road bike, knows how quickly the firm grip can hurt after a long time on the skin. Our new summer gloves offer you an

ergonomic palm padding with enough grip. The thin fabric is particularly breathable that you do not sweat too much. The reflective elements bring you more visibility, if the bike ride drags into the evening hours.



**CHILI MOD.24**

- lightweight summer glove
- backhand made of durable, air-permeable Lycra fabric with extra thin mesh inserts
- with reflective print for better visibility
- incl. ergonomic palm padding
- with silicone print for extra good grip even in wet conditions
- incl. pull-off system for quick and easy taking off
- with terry thumb to wipe off sweat
- black / grey

0.808.106/0 size S/7	002995
0.808.107/8 size M/8	002995
0.808.108/6 size L/9	002995
0.808.109/4 size XL/10	002995
0.808.110/2 size XXL/11	002995



**CHILI**

- light summer glove
- upper hand made of durable, breathable Lycra with extra thin mesh
- with reflective print on the upper hand for better visibility
- incl. ergonomic palm padding
- with silicone print for extra grip even in wet conditions
- incl. pull-off system for quick and easy taking off
- with terry thumb to wipe the sweat
- black

0.808.106/9 size S/7	002995
0.808.107/7 size M/8	002995
0.808.108/5 size L/9	002995
0.808.109/3 size XL/10	002995
0.808.110/1 size XXL/11	002995

NEW



**CROSSO MOD.24**

- lightweight summer glove
- backhand made of durable, air-permeable Lycra fabric
- with reflective print for better visibility
- incl. ergonomic palm padding
- with individual size adjustment by Velcro closure
- incl. pull-off system for quick and easy removal
- with terry thumb to wipe off sweat
- black / grey

0.808.101/1 size S/7	001995
0.808.102/9 size M/8	001995
0.808.103/7 size L/9	001995
0.808.104/5 size XL/10	001995
0.808.105/2 size XXL/11	001995



**CROSSO**

- light summer glove
- upper hand made of durable, breathable Lycra
- with reflective print for better visibility
- incl. ergonomic palm padding
- with individual size adjustment by Velcro clasp
- pull-off system for quick and easy taking off
- with terry thumb to wipe the sweat
- black / coolgrey

0.808.101/0 size S/7	001995
0.808.102/8 size M/8	001995
0.808.103/6 size L/9	001995
0.808.104/4 size XL/10	001995
0.808.105/1 size XXL/11	001995



**LADY JANE**

- light ladies summer glove
- upper hand made of durable, breathable Melange fabric for optimum fit
- palm padding for damping vibrations and protecting the joints
- incl. pull-off system for quick and easy taking off
- with terry thumb to wipe the sweat

0.808.089/7 grey / neored, size XS/6	001795
0.808.090/5 grey / neored, size S/7	001795
0.808.091/3 grey / neored, size M/8	001795
0.808.092/1 grey / neored, size L/9	001795
0.808.093/9 grey / neoblue, size XS/6	001795
0.808.094/7 grey / neoblue, size S/7	001795
0.808.095/4 grey / neoblue, size M/8	001795
0.808.096/2 grey / neoblue, size L/9	001795
0.808.097/0 grey / neogreen, size XS/6	001795
0.808.098/8 grey / neogreen, size S/7	001795
0.808.099/6 grey / neogreen, size M/8	001795
0.808.100/2 grey / neogreen, size L/9	001795

NEW



**TRIPSTER MOD.24**

- light summer glove
- backhand made of elastic, air-permeable fabric for optimal fit
- palm made of grippy Amara mesh for perfect ventilation and good grip
- incl. pull-off system for quick and easy taking off
- with terry thumb for wiping sweat

0.808.084/9 size S/7	001795
0.808.085/7 size M/8	001795
0.808.086/4 size L/9	001795
0.808.087/2 size XL/10	001795
0.808.088/0 size XXL/11	001795



**TRIPSTER**

- light summer glove
- upper hand made of elastic, breathable fabric for optimum fit
- palm made of grippy Amara mesh for perfect ventilation and good grip
- incl. pull-off system for quick and easy taking off
- with terry thumb to wipe the sweat

0.808.074/9 black / neored, size S/7	001795
0.808.075/6 black / neored, size M/8	001795
0.808.076/4 black / neored, size L/9	001795
0.808.077/2 black / neored, size XL/10	001795
0.808.078/0 black / neored, size XXL /11	001795
0.808.079/8 black / neoblue, size S/7	001795
0.808.080/6 black / neoblue, size M/8	001795
0.808.081/4 black / neoblue, size L/9	001795
0.808.082/2 black / neoblue, size XL/10	001795
0.808.083/0 black / neoblue, size XXL/11	001795
0.808.084/8 black / neogrey, size S/7	001795
0.808.085/5 black / neogrey, size M/8	001795
0.808.086/3 black/neogrey, size L/9	001795
0.808.087/1 black / neogrey, size XL/10	001795
0.808.088/9 black / neogrey, size XXL/11	001795

NEW



**PEPPER**

- lightweight long finger summer gloves
- backhand made of durable, air-permeable Lycra fabric with extra thin mesh inserts
- with reflective print for better visibility
- incl. 4mm ergonomic palm padding
- with silicone print for extra good grip even in wet conditions
- with terry thumb to wipe off sweat

0.808.123/0 size S/7	002995
0.808.123/1 size M/8	002995
0.808.123/2 size L/9	002995
0.808.123/3 size XL/10	002995
0.808.123/5 size XXL/11	002995

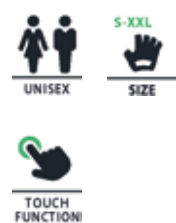

**SMOOTH CRIMINAL**

- light full-finger summer glove
- upper hand made of elastic and breathable mesh fabric
- palm with non-slip silicone print
- incl. 2mm neoprene wrist guard with welded seams
- with conductive coating on thumb and index finger to operate touch-screens
- black

0.808.220/8 size S/7	002795
0.808.221/6 size M/8	002795
0.808.222/4 size L/9	002795
0.808.223/2 size XL/10	002795
0.808.224/0 size XXL/11	002795



**UNICORN**

- light children glove
- upper hand made of durable, breathable Lycra for optimum fit
- incl. ergonomic palm padding
- with individual size adjustment by Velcro clasp
- incl. pull-off system for quick and easy taking off
- with terry thumb to wipe the sweat

0.808.120/0 size S/4	001595
0.808.121/8 size M/5	001595
0.808.122/6 size L/6	001595



**GIRLY**

- children light summer glove
- upper hand made of durable, breathable Lycra for optimum fit
- incl. ergonomic palm padding
- with individual size adjustment by Velcro clasp
- incl. pull-off system for quick and easy taking off
- with terry thumb to wipe the sweat

0.808.114/3 size S/4	001595
0.808.115/0 size M/5	001595
0.808.116/8 size L/6	001595



**SHARKY**

- children light summer glove
- upper hand made of durable, breathable Lycra for optimum fit
- incl. ergonomic palm padding
- with individual size adjustment by Velcro clasp
- incl. pull-off system for quick and easy taking off
- with terry thumb to wipe the sweat

0.808.117/6 size S/4	001595
0.808.118/4 size M/5	001595
0.808.119/2 size L/6	001595



**PIRATE**

- children light summer glove
- upper hand made of durable, breathable Lycra for optimum fit
- incl. ergonomic palm padding
- with individual size adjustment by Velcro clasp
- incl. pull-off system for quick and easy taking off
- with terry thumb to wipe the sweat

0.808.111/9 size S/4	001595
0.808.112/7 size M/5	001595
0.808.113/5 size L/6	001595







**RED LINE DWR DOWN**

- warming and elastic Taflan DWR lycra fleece
- waterproof and -repellent over welded seams
- with stop rubber against slipping
- incl. reflective elements

0.800.925/0 size S/M, 45cm	005995
0.800.926/8 size M/L, 46cm	005995
0.800.927/6 size L/XL, 47cm	005995



**RED LINE DWR UP**

- warming and elastic Taflan DWR lycra fleece
- waterproof and -reppelnt over welded seams
- with stop rubber against slipping
- incl. reflective elements

0.800.928/4 size S/M, 45cm	004995
0.800.929/2 size M/L, 46cm	004995
0.800.930/0 size L/XL, 47cm	004995



**RED LINE SLIM CAP**

- light melange fleece
- seamless for high comfort
- washable at 30°C

0.800.921/9 size S/M	001995
0.800.922/7 size L/XL	001995



**RED LINE HEAD BUFFER DLX**

- warm lycra thermofleece and nylon-windstopper material
- washable at 30°C

0.800.923/5 size S/M	002495
0.800.924/3 size L/XL	002495



**HOT HEAD**

- with synthetic leather label
- 100% soft-touch acrylic
- onesize

8.791.109/5 mottled grey	001495
--------------------------	--------



**HEAD SUPPORT**

- 85% polyacrylic and 15% wool
- universally adjustable
- unisex

8.791.228/3 grey with embroidered Contec logo	001495
---	--------



**RED LINE HEAT DLX**

- elastic 4mm neoprene
- waterproof over welded seams
- incl. zipper and fitting aid
- with Velcro for individual adjustment
- incl. hardened material at the toes
- with reflective elements

0.800.901/1 size 39 - 40	004995
0.800.902/9 size 41 - 42	004995
0.800.903/7 size 43 - 44	004995
0.800.904/5 size 45 - 46	004995
0.800.905/2 size 47 - 48	004995



**RED LINE SLEEK PRO**

- elastic 2mm neoprene
- waterproof over welded seams
- incl. Velcro for individual adjustment and fitting aid
- incl. reflective elements

0.800.906/0 size 39 - 40	004495
0.800.907/8 size 41 - 42	004495
0.800.908/6 size 43 - 44	004495
0.800.909/4 size 45 - 46	004495
0.800.910/2 size 47 - 48	004495



**RED LINE ROAD**

- thin and light lycra with PU coating
- waterproof over welded seams
- covers the shin with a higher shaft
- incl. reflective elements

0.800.911/0 size 39 - 40	003995
0.800.912/8 size 41 - 42	003995
0.800.913/6 size 43 - 44	003995
0.800.914/4 size 45 - 46	003995
0.800.915/1 size 47 - 48	003995



**RED LINE COMMUTER**

- breathable fleece with PU coating
- waterproof over welded seams
- incl. zipper and fitting aid
- with Velcro for individual adjustment
- incl. hardened material at the toes
- with reflective elements

0.800.916/9 size 39 - 40	003495
0.800.917/7 size 41 - 42	003495
0.800.918/5 size 43 - 44	003495
0.800.919/3 size 45 - 46	003495
0.800.920/1 size 47 - 48	003495



**RED LINE MICRO SHIELD**

- breathable
- made of 4mm neoprene
- waterproof via sealed seams
- black / reflex

0.800.931/8 onesize	001995
---------------------	--------







**SAFE R HEAD**

- suitable for bike helmets
- with elastic and cord closure
- waterproof

0.365.793/9 black / reflex	001495
0.365.795/4 safety yellow	001495



**SAFE R PACK**

- suitable for backpacks and baskets
- with elastic band
- waterproof
- size (LxW): 45 x 32cm

0.738.424/1 black /reflex	001995
0.738.425/8 safety yellow	001995

NEW



**SAFE SUPPORT**

- reflective surface
- two all-round reflective stripes
- easy to close with velcro fastener
- washable
- fluorescent yellow

8.791.115/2 unisex	000995
--------------------	--------



**TWEEZERS**

- thermoplastic - form stable and at the same time light
- with reflective stripes
- pair

0.319.490/9 black	000595
-------------------	--------



**R FLEX**

- highend reflective material
- with Velcro closure with adjustment

0.319.440/4 black	000695
-------------------	--------



**SNAP R**

- arm / trousers strap with automatic winding
- 3M Scotchlite reflective material
- 33cm long

0.319.441/2 yellow	000695
--------------------	--------





# Dim Sun



Elegant and stylish eye protection in the CONTEC Neo colors. Individually adaptable with flexible nose pad and temples.

Half-frame design for a complete field of view. Ideal for sport due to the less weight.



### 3 DIM

- 100% UV protection
- ultralight, durable and individually fit
- thermoplast frame, adaptable nose pad with grippy soft coating
- light polycarbonate exchangeable lenses
- toolfree filter exchange
- incl. etui and 2 pair spare lenses

0.804.910/8 black / neogreen	002995
0.804.911/6 black / neoblue	002995
0.804.912/4 black / neoyellow	002995
0.804.913/2 black / neored	002995



### DIM+

- 100% UV protection
- ultralight, durable and individually fit
- thermoplast frame, adaptable nose pad with grippy soft coating
- photochromic coating: automatic adjustment to the surrounding light
- incl. etui

0.804.920/7 black / coolgrey	006495
------------------------------	--------



### MINI BIKE

- black / blue / red
- 100% bio cotton
- unisex

0.806.430/5 size S	001995
0.806.431/3 size M	001995
0.806.432/1 size L	001995
0.806.433/9 size XL	001995
0.806.434/7 size XXL	001995



**STRESS REDUCTION**

white / black  
100% bio-cotton  
unisex

0.806.300/0 size S	001995
0.806.301/8 size M	001995
0.806.302/6 size L	001995
0.806.303/4 size XL	001995
0.806.304/2 size XXL	001995



**BRIGHT**

grey / black  
100% bio-cotton  
unisex

0.806.305/9 size S	001995
0.806.306/7 size M	001995
0.806.307/5 size L	001995
0.806.308/3 size XL	001995
0.806.309/1 size XXL	001995



**BIKE OFF**

red / black  
100% bio cotton  
unisex

0.806.310/9 size S	001995
0.806.311/7 size M	001995
0.806.312/5 size L	001995
0.806.313/3 size XL	001995
0.806.314/1 size XXL	001995



**DARK**

black / grey  
100% bio-cotton  
unisex

0.806.315/8 size S	001995
0.806.316/6 size M	001995
0.806.317/4 size L	001995
0.806.318/2 size XL	001995
0.806.319/0 size XXL	001995



**BRIGHT**

· grey / black  
· 85% bio-cotton / 15% polyester  
· unisex

0.806.325/7 size S	005995
0.806.326/5 size M	005995
0.806.327/3 size L	005995
0.806.328/1 size XL	005995
0.806.329/9 size XXL	005995



**DARK**

· black / grey  
· 85% bio-cotton / 15% polyester  
· unisex

0.806.320/8 size S	005995
0.806.321/6 size M	005995
0.806.322/4 size L	005995
0.806.323/2 size XL	005995
0.806.324/0 size XXL	006995



**BRIGHT**

· grey / black  
· 85% bio-cotton / 15% polyester  
· unisex

0.806.335/6 size S	006995
0.806.336/4 size M	006995
0.806.337/2 size L	006995
0.806.338/0 size XL	006995
0.806.339/8 size XXL	006995



**DARK**

· black / grey  
· 85% bio-cotton / 15% polyester  
· unisex

0.806.330/7 size S	006995
0.806.331/5 size M	006995
0.806.332/3 size L	006995
0.806.333/1 size XL	006995
0.806.334/9 size XXL	006995





**CROSSOVER**

- 100% light polyester
- windproof and water repellent
- lined with full-length zipperu
- unisex

0.806.353/0 size S	004995
0.806.353/1 size M	004995
0.806.353/2 size L	004995
0.806.353/3 size XL	004995
0.806.353/4 size XXL	004995
0.806.353/6 size 3XL	004995



**PUFFER**

- dark blue with white applications
- polyester / nylon fabric
- incl. inner pockets and hood

8.791.236/6 size S	007995
8.791.237/4 size M	007995
8.791.231/7 size L	007995
8.791.238/2 size XL	007995
8.791.239/0 size XXL	007995
8.791.240/8 size XXXL	007995







UNISEX

Suitable for any personality



## MERCHANDISE

### Love declaration

Who said that we can only equip your bike? For true CONTEC fans, we offer a colorful selection of merchandise to wear, put on your bike or take with you. We appreciate the support!

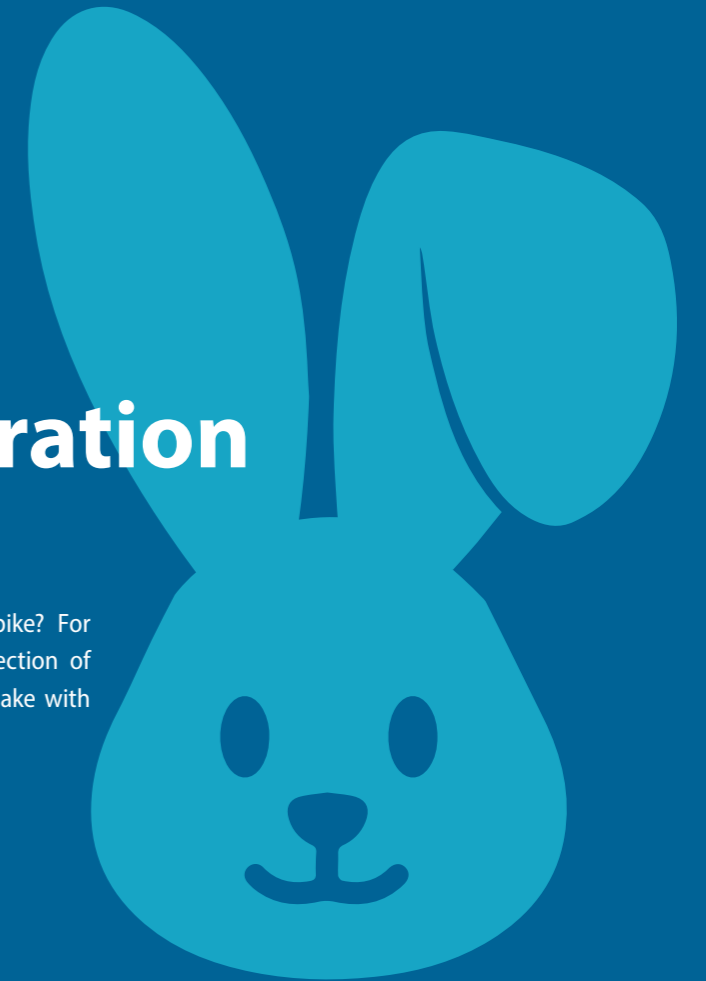

TIME.SUPPORT P.402



WATER.SUPPORT P.401

**BEACH FLAG**

- easy assembly
- incl. crossfoot (40 x 40cm)

8.791.175/6 (WxH) 0,75 x 1,65m

012995

NEW

**PEPE**

- soft cuddly bunny
- TÜV tested
- washable at 30°C on gentle cycle

8.790.234/0 brown

002495

NEW

**KEY.SUPPORT**

- high quality lanyard
- incl. safety clip in the neck

8.791.113/7 incl. Contec logo

000495

NEW

**FLOOR.SUPPORT**

- robust mat
- non-slip back

8.791.028/0 85 x 120cm

015995

8.791.028/1 60 x 200cm

019995

NEW

**MOUSE.SUPPORT G-LINK**

- printed and scratch resistant plastic
- non-slip underside made of cellular rubber

8.791.027/1 400 x 300mm

000995

**BALL PEN**

- made of paper
- with 100% corn based PLA plastic details
- blue ink

8.791.229/1 red / blue / green - colour sorted

000095

**PEN SUPPORT**

- DIN A5
- 50 sheets

8.790.106/2 incl. Contec logo

000172

NEW

**WATER.SUPPORT**

- made of glass with lid made of high quality plastic
- capacity: 470ml
- BPA-free
- leakproof
- dishwasher safe

0.319.888/0 dark grey

001499

**TIME.SUPPORT**

- made of black 20" rim
- high quality oak veneer

8.791.223/4 with Contec logo	005995
------------------------------	--------

**NEW**

UNISEX

**NECK.SUPPORT**

- extra soft polyester
- black / red / blue

8.791.029/0 50 x 25mm	000595
-----------------------	--------

**NEW**

UNISEX

**USE.SUPPORT**

- 100 % Q-Skin fiber
- breathable and soft
- washable until 30°C
- green

8.791.027/2 size 39-42	001495
------------------------	--------

8.791.027/3 size 43-46	001495
------------------------	--------

**NEW****CARRY.IT**

- made of stable paper with twisted cord handle
- base paperboard reinforced

8.791.027/0 25 x 12 x 32cm (LxWxH)	000195
------------------------------------	--------

**COTTON**

- made of 100% cotton
- with long carrying handle

8.791.227/5 beige / green / black	000495
-----------------------------------	--------

**POSTER**

- with CONTEC disc pads in original sizes

8.791.049/3 for easy classification of disc pads	000195
--	--------





# GENERAL TERMS AND CONDITIONS OF SALE AND DELIVERY OF HERMANN HARTJE KG

ISSUE DECEMBER 2021

## Section 1 Scope

(1) These General Terms and Conditions of Sale and Delivery (hereinafter referred to as GCS) apply to all sales and deliveries as well as to all other services (e.g. also for works) of Hermann Hartje KG (hereinafter referred to as "Hartje" or "we"). These GCS are an integral part of all our contract offers and contract acceptances and apply to all services rendered by us, including orders placed via our EOS-Web.

(2) These GCS apply exclusively. Any deviating, conflicting or supplementary general terms and conditions of the buyer will not be recognised by us, even if we do not expressly object to their validity. This will also apply if we perform the service without reservation in the knowledge of the buyer's terms and conditions. The buyer's terms and conditions of business will become part of the contract as an exception only if we have expressly agreed to their validity in text form.

(3) Individual agreements made with the buyer on a case-by-case basis (including ancillary agreements, supplements and amendments) take precedence over these GCS. Such agreements must be made or confirmed in writing for evidence purposes. Subject to evidence to the contrary, the contract or our written confirmation will be decisive for the conclusion and content of such agreements.

(4) These GCS also apply to all future transactions with the buyer, even if we do not refer to the validity of the GCS again.

(5) These GCS apply only to entrepreneurs within the meaning of Section 14 of the German Civil Code (BGB).

(6) References to the applicability of statutory provisions are for clarification purposes only. In addition to these GCS, the statutory provisions also apply without any reference to them, unless they are directly amended or expressly excluded in these GCS.

(7) Insofar as these GCS require compliance with written form, compliance with text form within the meaning of Section 126b BGB will also be sufficient. Statutory formal requirements remain unaffected.

## Section 2 Offers, Conclusion of contract, Documents

(1) Cost estimates, price and delivery information, for example in catalogues and presentations on the Internet, do not constitute legally binding offers, but are to be understood as an invitation to the buyer to submit an offer. Orders placed by the buyer are binding offers to us, to which the buyer is bound for 14 days in case of doubt. The contract comes into effect when we confirm the buyer's order, commence with fulfilment of the contract or deliver the goods. The buyer waives receipt of our declaration of acceptance. If, by way of exception, our declaration is to be understood as a legally binding offer, we are entitled to revoke our offer at any time until acceptance by the buyer, unless the offer expressly states otherwise.

(2) Cost estimates, sketches, drawings, illustrations, performance descriptions and other documents which are not part of the scope of delivery will remain our property and we reserve all copyrights there-to. They may not be made accessible to third parties and must be returned immediately upon request.

(3) Supplementary information for orders via EOS-Web: We deliver exclusively to entrepreneurs. No sale to consumers takes place. Orders are only possible after registration and approval of the buyer for orders via EOS-Web. The ordering process consists of the following steps: After logging in with their registration data, the buyer can place the goods in a virtual shopping basket without obligation by clicking on the button with the shopping basket symbol. The buyer can view the contents of the shopping basket at any time by clicking on the shopping basket symbol and can delete products from the shopping basket or change the quantity using the fields provided. Before placing an order, the buyer has the opportunity to check all details and correct any input errors using the editing fields provided. Only by clicking on the field "order subject to payment" does the buyer submit a binding offer to conclude a purchase contract. Unless otherwise agreed in individual cases, the buyer will receive an automatically generated confirmation of receipt after placing their order. This does not constitute acceptance of the contract.

The contract comes into effect when we confirm the buyer's order in writing or inform the buyer about shipment of the goods or deliver the goods. We save the text of the contract. The buyer can view, print and save these GCS as part of the order process. The contract language is German. The buyer can save and/or print out the contents of the order immediately after placing the order. Later inspection of the order history is possible via the user account. It is not possible to view the version of the GCS applicable at the time of conclusion of the contract there.

## Section 3 Prices, Terms of payment

(1) Our prices are quoted in EURO plus statutory value added tax at the applicable rate. Unless otherwise agreed, the prices are ex warehouse (exw Incoterms 2020) plus costs for shipping (cf. Section 4), packaging and insurance, customs duties or other taxes. In drop shipments, the prices will apply ex works (exw Incoterms 2020) of our supplier. Unless otherwise agreed, the prices valid on the date of conclusion of the contract will apply. For invoice amounts below EUR 50.00 we charge a handling fee of EUR 5.00 for small orders.

(2) The prices stated for our delivery are based on the circumstances prevailing at the time of conclusion of the contract. In the event of unforeseeable significant changes in costs after conclusion of the contract which are beyond our control, e.g. increases in freight rates, transport costs, taxes, customs duties or other public charges, currency fluctuations, price increases for raw materials or supplies, we are entitled to adjust the prices at our reasonable discretion. In the event of price increases of more than 15% of the net price, the buyer will be entitled to withdraw from the contract. For price increases due to supply bottlenecks, which we have pointed out before conclusion of the contract, Section 5 Para. 3 applies.

(3) Invoice amounts are due for payment upon receipt of the invoice and delivery or acceptance of the goods. Deductions such as cash discounts are not permitted unless expressly agreed with the buyer. The buyer will automatically be in default if the invoice amount is not paid within the agreed payment period or the payment period stated in the invoice or, if no deviating payment period is stated, within 14 days of receipt of the invoice. The date of receipt of the payment by us will be decisive. An earlier occurrence of default in accordance with the statutory provisions, in particular by means of a reminder, will remain unaffected.

(4) We are entitled at any time, including within the framework of an ongoing business relationship, to conclude a contract in whole or in part only against advance payment.

(5) We are entitled to issue invoices in electronic form.

(6) During a delay in payment, the buyer is obliged to pay as minimum damages default interest and lump-sum damages in accordance with the statutory provisions. The assertion of damages in excess of this is not excluded. With respect to merchants, our claim to the commercial due date interest (Section 353 German Commercial Code (HGB)) remains unaffected.

(7) If it becomes apparent after conclusion of the contract (e.g. due to an application for the opening of insolvency proceedings, default with other performance obligations) that our claim to the purchase price is jeopardised by the buyer's lack of ability or willingness to perform, we will be entitled to refuse performance and - if necessary after setting a deadline - to withdraw from the contract. Section 321 BGB will apply (mutatis mutandis). Special agreements (including special discounts) are void in this case.

(8) The buyer will be entitled to rights of set-off and retention if its counterclaims have been legally established, are undisputed or have been recognised by us.

## Section 4 Delivery, Shipping costs and Transfer of risk

(1) Unless otherwise agreed, delivery will be ex warehouse (exw Incoterms 2020).

(2) If we undertake dispatch of the goods for the buyer or carry out the transport ourselves, the transport will be at the buyer's expense, unless otherwise agreed. The choice of shipping route and transport will be made at our discretion without any special agreement. Insofar as we take into account the buyer's wishes, any additional costs incurred as a result will be borne by the buyer.

(3) The shipping options and shipping costs applicable to orders via EOS-Web will be displayed to the buyer in the order process under "Shipping method".

(4) The risk will be transferred to the buyer no later than when the delivery item is handed over (whereby the start of the loading process is decisive) to the forwarding agent, carrier or other third party designated to carry out the shipment. In the case of transports carried out by ourselves, this will not apply if a separate fee has been agreed with the buyer to cover transport risks ("flat-rate insurance fee"). In this case, the risk will not pass to the buyer until the goods have been made available at the place of delivery.

## Section 5 Delivery periods/Delay in delivery

(1) Details of delivery dates are non-binding unless they have been agreed in writing as binding dates. An agreed delivery period will commence no earlier than upon conclusion of the contract, but not before the technical and commercial details of the execution of the order have been fully clarified. The commencement of all periods applicable to us also presupposes the timely fulfilment of all necessary acts of cooperation, in particular the timely receipt of all necessary information, as well as compliance with the agreed terms of payment by the buyer. In the event that duties to cooperate are not fulfilled in good time, delivery periods will not commence or will be extended accordingly.

(2) Delivery will be made subject to timely and proper self-delivery by our suppliers. We do not assume any procurement risk. In the event of non-availability of the service, we will inform the buyer.

(3) If we are unable to secure the delivery at the time of conclusion of the contract due to supply bottlenecks on the part of our suppliers by means of corresponding covering purchases and if we have informed the buyer in an appropriate and reasonable manner of supply bottlenecks and the possibility of price increases before conclusion of the contract, the following will apply:

- The agreement is made subject to availability. The delivery time will be extended until the goods are available.

- The buyer is entitled to withdraw from the contract if delivery is not made within three months of the agreed delivery date.

- We are entitled to pass on price increases by our suppliers to the buyer in the meantime. The buyer is entitled to withdraw from the contract if the price increase is more than 15%. Further claims of the buyer are excluded.

(4) We will not be liable for non-deliveries or delays in delivery if these are due to force majeure or any other impediment beyond our control and we could not reasonably be expected to consider the impediment or to avoid or overcome the impediment or its consequences. This applies, for example, to acts of war, terrorism, acts of nature, operational, transport and traffic disruptions, non-delivery of supplies and raw materials, strikes, lawful lock-outs, official orders, mass illnesses, epidemics and pandemics, manufacturing disruptions including machine breakdowns and labour shortages. In such cases, we will inform the buyer of the reason for the impediment and its effects. If such an event makes it considerably more difficult or impossible for us to deliver or perform and the hindrance is not only temporary, both parties are entitled to withdraw from the contract. In the event of temporary hindrances, our delivery or service deadlines will be extended or our delivery or service deadlines will be postponed by the period of the hindrance plus a reasonable start-up period. Either party will be entitled to withdraw from the contract if the resulting delay exceeds a period of three months or if, as a result of the delay before the expiry of this period, it can no longer be reasonably expected to adhere to the contract, with the consequence that any advance payments made will be refunded. No other claims exist.

(5) Partial deliveries are permissible insofar as they are reasonable. Invoices issued for partial deliveries will be due for payment irrespective of the total delivery.

(6) If we are in default of performance, the buyer will afford us the opportunity to perform within a reasonable period of time. As a rule, the period of grace will be at least three weeks.

(7) In the event of a delay in delivery or impossibility, liability for damages will only exist in accordance with Section 9.

## Section 6 Obligations of the buyer, General obligations of the buyer to cooperate, Liability of the buyer for damages

(1) We only deliver to knowledgeable buyers. Vehicles are not delivered by us in an assembled condition ready for sale, but require final assembly. This is the responsibility of the buyer. The buyer is obliged to carry out the final assembly, the assembly of components as well as the installation of parts or components carefully and only through skilled and competent mechanics. In the event of an injury, the buyer will be liable for all resulting damages. The buyer will indemnify us against all possible damages and disadvantages resulting from faulty assembly by the buyer.

(2) The buyer is obliged to provide, in a timely manner, all cooperations that are contractually regulated, necessary or owed in good faith. For example, the buyer is obliged to issue a confirmation of receipt without being asked to do so in accordance with the statutory provisions. The parties undertake to cooperate in a spirit of trust and will support each other, for example in the settlement of warranty claims.

(3) We are entitled to set the buyer a reasonable time limit for the performance of an act of cooperation. After unsuccessful expiry of the time limit, we will be entitled to withdraw from the contract.

(4) Unless stipulated otherwise in these GCS, the buyer will be liable in accordance with the statutory provisions. If the buyer owes damages instead of performance, we will be entitled to demand lump-sum damages in the amount of 15% of the performance, unless the buyer proves a lower extent of damage. We reserve the right to claim higher damages in accordance with the statutory provisions.

## Section 7 Retention of title

(1) Our deliveries are subject to retention of title. We retain ownership of the delivered goods until the purchase price and all other existing or (at the time of the conclusion of the contract) future claims (including all balance claims from the current account) against the buyer arising from the business relationship have been settled in full. Ownership of the goods automatically passes to the buyer as soon as the purchase price has been paid and no further claims from the business relationship exist (current account reservation).

(2) Any processing or treatment of the goods subject to retention of title by the buyer will always be carried out for us as the processor within the meaning of Section 950 BGB. If the goods subject to retention of title are processed by the buyer, it is agreed that the processing will be carried out in our name and for our account as manufacturer and that we directly acquire ownership of the newly created item. If the goods are processed with other items not belonging to us, we will acquire co-ownership of the new item in the ratio of the value of the goods subject to retention of title (invoice value including VAT) to the other processed items at the time of processing. If the goods subject to retention of title are inseparably combined or mixed with other items not belonging to us, we will acquire co-ownership of the new item in the ratio of the value of the goods subject to retention of title (final invoice amount including VAT) to the other combined or mixed items at the time of combination or mixing. If the goods subject to retention of title are combined or mixed in such a way that the buyer's item is to be regarded as the main item, the buyer and we already agree now that the buyer will transfer co-ownership of this item to us on a pro rata basis (in proportion to the value of the raw materials). We accept this transfer. The provisions for goods subject to retention of title apply accordingly to the products resulting from processing, mixing or combining, in so far as they are our property.

(3) The buyer is obliged to treat the goods subject to retention of title with care at its own expense, to store them carefully for us and to insure them adequately against the usual risks (e.g. theft, breakage, fire, water) at replacement value and to provide evidence of the conclusion and existence of the insurance policy upon request. We are entitled to insure the goods subject to retention of title at its expense. We may at any time demand that the buyer keep an inventory of the goods delivered by us at its respective storage location and identify the goods as our property. Insurance claims as well as claims against third parties due to damage, destruction, theft or loss of the goods are already now assigned to us by the buyer by way of security. We hereby accept this assignment.

(4) The buyer will inform us immediately of any seizures and other impairments of our rights by third parties.

(5) The buyer is entitled to sell the goods subject to retention of title in the ordinary course of business. Pledges and transfers by way of security are only permitted with our prior written consent. The authorisation will automatically expire if the buyer is in default of payment, the opening of insolvency proceedings against its assets has been applied for, or it is obliged to apply for insolvency proceedings. In the event of a resale of the goods subject to retention of title on credit, the buyer is obliged to sell the goods only against sufficient collateral (e.g. agreement of its own reservation of title).

(6) The buyer hereby assigns to us by way of security any claims against third parties arising from the resale of goods subject to retention of title in the amount of the share corresponding to our ownership share. The assignment is furthermore limited to a maximum of the amount of the invoice value of our claims (including value added tax) to which we are entitled against the buyer from the business relationship at the time of the resale, plus a security surcharge of 20%.

(7) The buyer is authorised to collect the claims assigned to us from the resale. The proceeds to which we are entitled will be forwarded to us immediately upon receipt. At our request, the buyer will inform us of the names of the debtors of the assigned claim and notify them of the assignment. We are authorised to inform the buyers of the assignment also on its behalf. The direct debit authorisation will automatically expire if the buyer is in default of payment, the opening of insolvency proceedings against its assets has been applied for, or it is obliged to apply for insolvency proceedings.

(8) Notwithstanding any automatic expiry, we will be entitled to revoke the resale and/or further processing authorisation and/or the collection authorisation if the buyer breaches its obligations towards us, in particular if it fails to properly fulfil its payment obligations arising from the business relationship, in particular if it is in default of payment, or if it breaches its obligations as a conditional buyer or if it becomes apparent after the conclusion of the contract that our payment claims arising from the business relationship with the buyer are jeopardised by the buyer's inability to pay. In the event that the collection authorisation expires, the buyer will provide us with the information on the claim required for collection and, if necessary, support us in the collection process.

(9) Furthermore, in the event of conduct in breach of contract on the part of the buyer, we will be entitled to withdraw from the contract in accordance with the statutory provisions. Alternatively, provided that the prerequisites for withdrawal are met, we are also entitled to demand only the return of the goods and to expressly reserve the right to withdraw from the contract. If such an express reservation of withdrawal is not declared, the demand for surrender will be deemed to be a declaration of withdrawal. The same will apply if we seize the goods subject to retention of title. The transport costs incurred for taking back the goods will be borne by the buyer. We will be entitled to utilise any goods subject to retention of title taken back by us. The proceeds of the realisation will be offset against the amounts owed to us by the buyer after we have deducted a reasonable amount for the costs of the realisation.

(10) The buyer will notify us of any third-party seizure of the goods subject to retention of title immediately after it becomes known, and will provide us with all information and documents necessary for an intervention. The buyer is liable for the costs incurred for the cancellation of the seizure, in particular by filing a third-party action, insofar as they cannot be obtained from the creditor seeking the seizure.

## Section 8 Condition of the goods, Warranty

(1) Information on the condition of the goods does not constitute a guarantee. A guarantee will only be given if it has been expressly designated as such in writing using this term.

(2) We will not be responsible for defects based on the defectiveness of supplied parts unless we have given a guarantee in this respect or the defect was known or obvious to us. We are not obliged to carry out quality control of supplied parts.

(3) A prerequisite for any warranty claims is that the buyer fulfils its obligations to inspect and give notice of defects. The buyer is obliged to immediately inspect the delivery or service for defects, including incorrect deliveries and deviations in quantity, for all services rendered by us. In the case of goods intended for installation or other further processing, the inspection must in any case be carried out before processing. Obvious defects must be notified in writing, if possible upon delivery, but no later than on the working day following delivery. Other defects that are recognisable upon proper inspection within the meaning of Section 377 of the German Commercial Code (HGB) must be notified in writing within five working days of delivery. Defects that are not recognisable on proper inspection must be notified in writing within two working days of discovery. Timely dispatch of the notice will be sufficient to preserve the rights. If defects are not notified in accordance with the above provisions, the delivery will be deemed to have been approved in accordance with the contract. Notices on delivery notes are not deemed to be notification of defects. Transport personnel are not entitled to receive notifications of defects. The above obligations to give notice of defects will also apply to work performances with the proviso that acceptance will be decisive instead of delivery.

(4) The burden of proof for the existence of a defect lies with the buyer.

(5) In the event of proven defects, we will, at our discretion, provide a warranty by rectifying the defect free of charge or by making a subsequent delivery (supplementary performance). We are entitled to demand that the buyer return the defective goods to us in advance for the purpose of investigating the complaint and, if necessary, for subsequent improvement or subsequent delivery. The place of performance for supplementary performance is our plant. Furthermore, we are entitled to demand that

the buyer carry out the subsequent improvement itself, provided that this is reasonable for the buyer. In this case, we will reimburse the buyer for the necessary expenses.

(6) If the buyer has installed the goods in another item or attached them to another item in accordance with their type and their contractual purpose, we will be entitled within the scope of subsequent performance to undertake the removal of the defective item and the re-installation of the defect-free item ourselves or to leave the removal and installation to the buyer. In the latter case, we will reimburse the buyer for the necessary expenses. The buyer will set us a reasonable notice period within which we can carry out the removal of the goods on our own responsibility. Our right to refuse subsequent performance due to disproportionate costs remains unaffected. Subsequent performance will in any case be disproportionate if the costs of subsequent performance amount to more than 120% of the purchase price.

(7) In the event that the goods are returned for the purpose of subsequent improvement or delivery, the goods must be returned without any accessories or equipment subsequently attached. We accept no liability for accessories and equipment supplied with the goods.

(8) The buyer may only withdraw from the contract or reduce the purchase price if no attempt is made to remedy the defect within a reasonable period of time set by us or if the remedy is impossible, refused, failed or unreasonable. The period for subsequent performance must be at least four weeks, provided that no justified interests of the buyer contradict this. In the event of doubt, failure of the supplementary performance will only be assumed after the third failed attempt at supplementary performance. The buyer is not entitled to withdraw from the contract on grounds of insignificant defects. In addition to the statutory requirements, the special provisions in Section 9 apply to claims for damages due to defects.

(9) Due to defects, the buyer may only withhold payments to an extent that is reasonable in relation to the defects that have occurred.

(10) The statutory provisions on the buyer's recourse pursuant to Sections 445a, 445b, 478 BGB will apply with the following provisos: Prior to subsequent performance by way of replacement delivery or replacement of components, the buyer will inform us without delay and give us the opportunity to fulfil the claims for defects asserted against the buyer ourselves. The same applies if the buyer intends to commission a third party with subsequent performance by way of rectification of defects. Compensation for expenses incurred by the buyer without any legal obligation towards its customer, in particular as a gesture of goodwill, will only be made if we have agreed to the measure in advance. Recourse on the part of the buyer is excluded insofar as an item not intended for installation is installed. Claims arising from supplier recourse will be excluded in any case if the defective goods have been further processed by the buyer or another entrepreneur, for example by installation in another product or inseparable connection with another product. For the processing of recourse claims, at least the presentation of the original sales receipt from the resale and, in the case of vehicles, the original of the handover protocol to the buyer's customer as well as the return of the defective goods/parts are required. We are entitled to demand further evidence.

## Section 9 Buyer's right to withdraw from the contract and claims for damages

(1) The statutory provisions will apply to the right to withdraw from the contract with the proviso that the buyer may only withdraw from the contract due to a breach of duty not consisting of a defect if we are responsible for the breach of duty.

(2) In principle, we will only be liable for damages, insofar as the other requirements for claims are met, if we are guilty of intent or gross negligence. We will be liable for simple negligence in the event of a breach of an obligation the fulfilment of which is a prerequisite for the orderly implementation of the contract and on the observance of which the buyer may regularly rely (so-called cardinal obligation). In all other respects, liability for damages of any kind, regardless of the basis of the claim, including liability for default upon conclusion of the contract, is excluded.

(3) If we are liable for slight negligence, our liability will be limited to the damage foreseeable at the time of conclusion of the contract and typical for the contract. In the event of slight negligence, there will be no liability for indirect damage or consequential damage.

(4) For damage caused by delay, we will be liable to a maximum of 5% of the value of the service in default.

(5) The above exclusions and limitations of liability do not apply if we are liable for intent or gross negligence, if we have assumed a guarantee, for damages that are to be compensated under the Product Liability Act or for damages to life, limb or health.

(6) The above exclusions and limitations of liability will also apply in favour of our employees, vicarious agents and other third parties whom we use for the performance of the contract.

## Section 10 Statute of limitations

(1) The limitation period for claims based on defects is one year from the date of delivery.

(2) Other contractual claims of the buyer due to breach of duty are subject to a limitation period of one year. This does not apply to the buyer's right to withdraw from the contract due to a breach of duty for which we are responsible and which is not due to a defect.

(3) By way of derogation, the statutory limitation periods will apply to the following claims of the buyer:

- Claims for damages arising from product liability, for damages arising from injury to life, limb, health or a material contractual obligation as well as for other damages based on an intentional or grossly negligent breach of duty by us or our vicarious agents
  - Claims under a right of recourse pursuant to Section 445b Para. 1 BGB
  - Claims due to fraudulent concealment of a defect.
- (4) Our claims against the buyer will become statute-barred in accordance with the statutory provisions.

## Section 11 Choice of law, Place of performance and Place of jurisdiction

(1) The law of the Federal Republic of Germany will apply, to the exclusion of the UN Convention on Contracts for the International Sale of Goods.

(2) The place of performance is Hoya.

(3) In legal transactions with merchants, Hoya is agreed as the exclusive place of jurisdiction for legal actions against us. We are also entitled to bring legal action at the buyer's general place of jurisdiction.

(4) Should individual provisions of the contract, including these GCS, be or become invalid in whole or in part, this will not affect the validity of the remaining provisions. In this case, the wholly or partially invalid provision will be replaced by a provision whose economic success comes as close as possible to that of the invalid provision.



Subject to colour, equipment and price changes with printing errors excepted Version 06/2023

Hermann Hartje KG  
Deichstr. 120-122  
27318 Hoya  
Phone: +49 42 51 - 8 11 20  
Fax: +49 42 51- 8 11 159  
info@contec-parts.com  
www.contec-parts.com