

Bedienungsanleitung Manual
Multifunktionswerkzeug Multi Tool
Treasure Fork

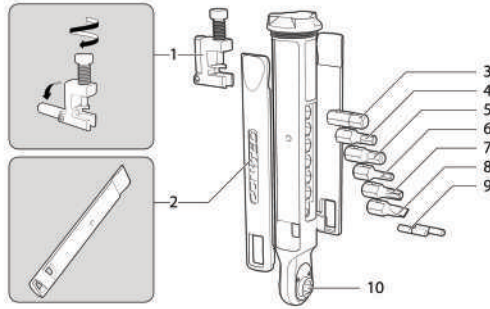

Lieferumfang Contents



- 1 Kettennietrucker Chain Breaker
- 2 2 x Reifenheber 2 x Tire Lever
- 3 6mm Innensechskantschlüssel 6mm Hex
- 4 4mm Innensechskantschlüssel 4mm Hex
- 5 5mm Innensechskantschlüssel 5mm Hex
- 6 3mm Innensechskantschlüssel 3mm Hex
- 7 T25 Innensechsrundschlüssel T25 Torx
- 8 Schlitzschraubendreher Slotted Screwdriver
- 9 2 x Kettensatzpins 2 x Chain Pin
- 10 Ratschen-Steckschlüssel Ratchet
- 11 Installationshülse Installation Tube
- 12 Befestigungsschraube Fixing screw

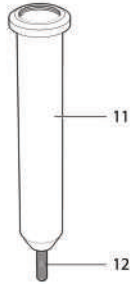

Bestimmungsgemäße Verwendung
Intended Use

Standard Gabelschaft Standard Steerer Tube

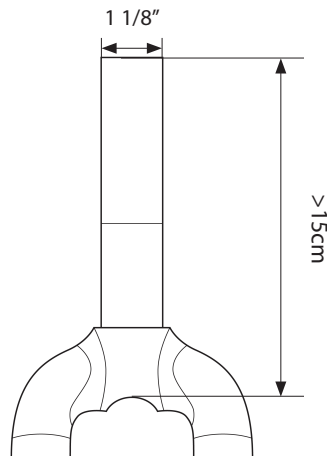

Benötigte Werkzeuge Required Tools

[Inklusive]
[Included]



Installations-
werkzeug
Installation Tool



Innensechskant-
schlüssel
Hex Wrench

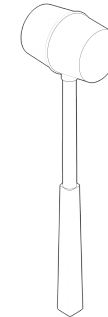

Gummihammer
Rubber Hammer

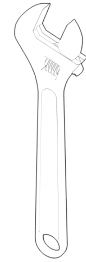

Schraubenschlüssel
Wrench

Montage Installation

1

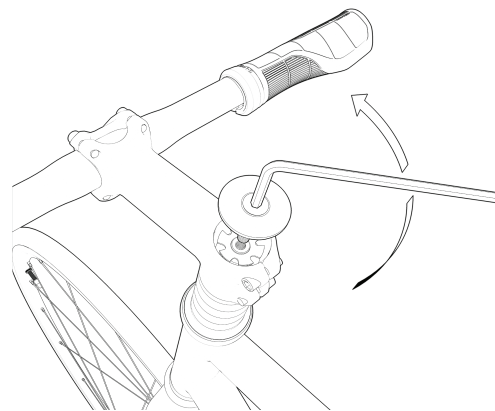

3

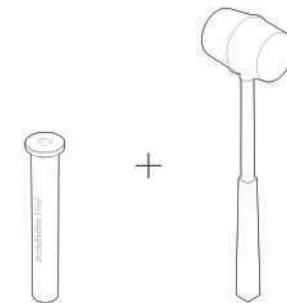

2

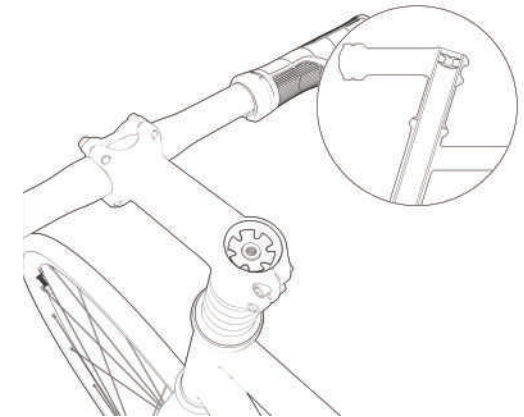

4

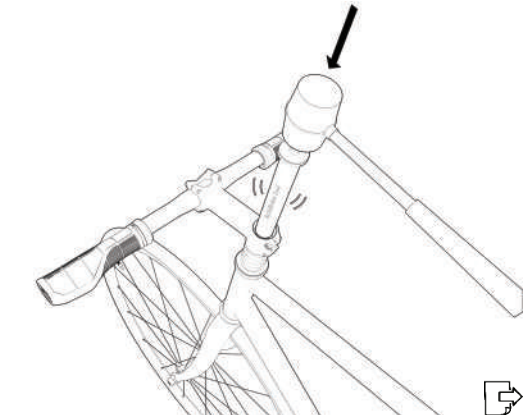

Montage Installation

5

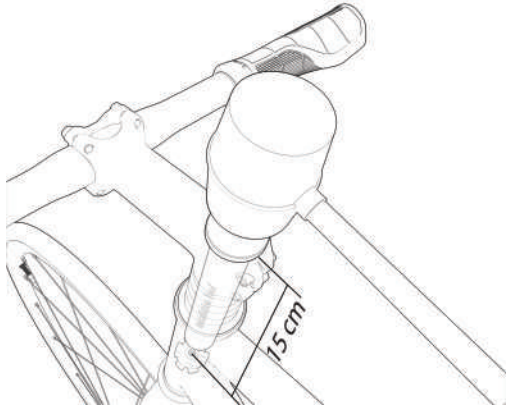

6

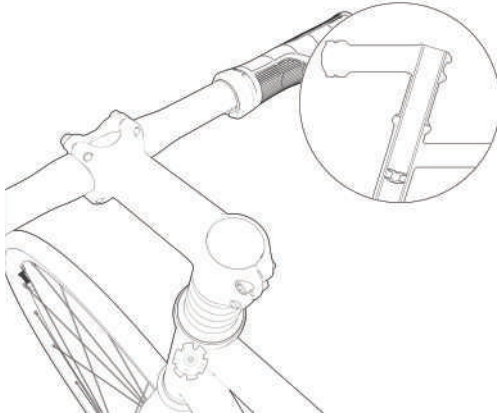

7

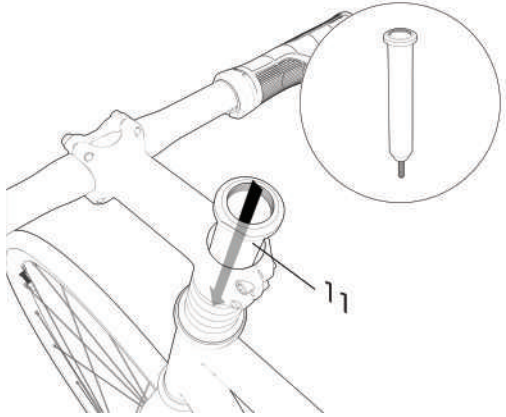

8

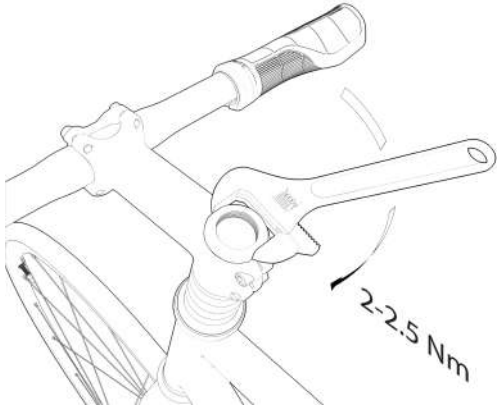

9

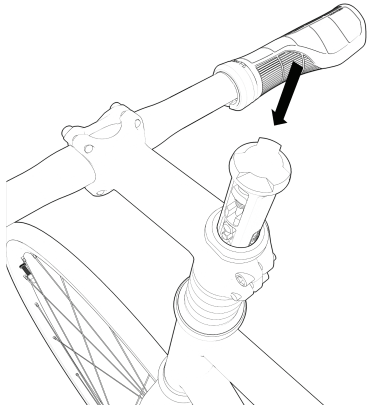

10

